

City of Prineville

TRANSPORTATION SYSTEM PLAN

November 2013

VOLUME 2



Volume Two of the City of Prineville Transportation System Plan (TSP) provides a record of each technical memorandum produced during the TSP development process as well as the minutes summarizing discussion at each Technical Advisory Committee/Public Advisory Committee meeting. These documents summarize the process of developing the final TSP and may therefore include alternatives that were further refined or evaluated, which may not be included in the final TSP.

TABLE OF CONTENTS

Section 1	Technical Memorandum 1: Plan and Policy Review
Section 2	Technical Memorandum 2: Goals and Objectives
Section 3	Technical Memorandum 3: Existing Conditions Inventory
Section 4	Technical Memorandum 4: Existing Conditions Analysis
Section 5	Technical Memorandum 5: Future No-Build Conditions
Section 6	Technical Memorandum 6: Alternatives Analysis
Section 7	Technical Memorandum 7: Preferred Alternative
Section 8	TAC/PAC Meeting Minutes

Section 1
Technical Memorandum 1: Plan and Policy Review



CITY OF PRINEVILLE TRANSPORTATION SYSTEM PLAN



TECHNICAL MEMORANDUM #1: PLANS & POLICY REVIEW

This memorandum summarizes existing plans, policies, standards, rules, regulations, and other applicable federal, state, regional, and local documents as they pertain to development of the City of Prineville Transportation System Plan (TSP). This summary will serve as a reference for the project team throughout the project, and if new policies are proposed as part of the TSP they will be reviewed for consistency with existing policies.

The documents reviewed by the project team are identified in Table 1-1 and summarized in the following sections. Several of the key transportation issues identified through this review are summarized below.

- The ODOT roundabout policy that influenced the OR 126 Corridor Plan has been amended. This amendment would allow roundabouts on the State highway system if proper coordination with affected stakeholders demonstrates that all users can be appropriately accommodated.
- The OR 126 Corridor Plan identifies options for the Tom McCall, O'Neil Highway, and "Y" Junction that need to be further evaluated as part of the TSP. In particular, the traffic growth estimates for the corridor plan were developed prior to completion of a travel demand model and need to be revisited to ensure the potential solutions are still applicable.
- Data center development near the airport has provided a new outlook on Prineville's economic growth potential. Although the data centers impact the transportation system during construction, the long-term impacts and travel demands are low.
- State highway mobility targets and access standards have changed since the prior TSP was adopted; the new policies will enable more flexibility for the long-term growth of the city and needed transportation infrastructure.
- A number of large properties have been master planned during the past ten years. The growth patterns and associated infrastructure for these properties was not fully accounted for in the previously-adopted TSP. In particular, the Ochoco lumber site will be a key redevelopment site within Prineville given its size and location. The TSP process should account for this as a future mixed-use site.
- The completion of the 2nd Street extension has provided the City with an alternate route to 3rd Street – US 26/OR 126; the benefits of this corridor and associated changes in travel patterns and transportation system needs will be evaluated through the TSP effort.

- The existing transit infrastructure in Prineville is very limited, with Cascades East Transit service provided through a park-and-ride located along the Prineville “Y.” On-going regional park-and-ride studies will need to be monitored and amended into this TSP effort as findings are developed.
- The City of Prineville is actively improving pedestrian facilities around schools and its Ochoco Creek trail system. These actions follow development of Safe Routes to Schools Plans. Additional connectivity needs remain both for sidewalks and trails and will be included in the TSP update.
- The City is also considering changes to Main Street – McKay between Peters Road south into 3rd Street. These efforts will occur in parallel with the TSP and may include an additional traffic signal at 9th Street, pedestrian and bicycle improvements throughout the entire corridor, and enhancements to the alignment of the existing traffic signal at 10th Street.

Table 1-1 Documents and Policies Reviewed

Document/Policy	Page Reference
Statewide Planning Documents	
Statewide Planning Goals (OAR chapter 660 division 012, known as the Transportation Planning Rule or TPR)	3
Transportation System Planning Guidelines	5
Oregon Transportation Plan	5
Oregon Highway Plan (as amended)	6
Oregon Aviation Plan	12
Oregon Bicycle/Pedestrian Plan	12
Oregon Freight Plan	13
Oregon Public Transportation Plan	13
Oregon Rail Plan	14
Transportation Safety Action Plan	14
OAR Chapter 734 Division 051	16
ODOT Highway Design Manual	17
Statewide Transportation Improvement Program	18
House Bill 3379 Administrative Rule Background	19
Regional Planning Documents	
Hwy 126 Corridor Facility Plan	19
Cascades East Transit Regional Transportation Plan	20
Central Oregon Rail Plan	21

(Continued on next page)

Table 1-1 (Continued)

County Planning Documents	
Crook County Parks and Recreation District Master Plan	22
Crook County Comprehensive Plan	24
Crook County TSP	25
City/Local Planning Documents	
City Comprehensive Plan	27
City of Prineville Transportation System Plan	36
City of Prineville Downtown Enhancement Plan	37
Prineville/Crook County Airport Master Plan	37
City of Prineville Land Use Code (Chapter 153)	40
City's Standards and Specifications	41
City's Buildable Lands Inventory	42
City's current and past budget for transportation	42
City's current and historic funding and sources	43

STATE OF OREGON/ODOT

Statewide Planning Goals

Oregon's Statewide Planning Goals first originated in 1973 to provide a coordinated vision of state land use policies. There are nineteen planning goals within OAR 660-015. Of these, Goal 15 is only relevant to the Willamette Greenway and Goals 16 through 19 are relevant only to coastal communities. While not all of the goals are mandatory, each has been adopted as an Oregon Administrative Rule (OAR) to be followed by government agencies. A summary of the planning goals is provided below.

- Citizen Involvement (Planning Goal 1) – To develop a citizen involvement program that provides the opportunity for engagement in all phases of the planning process.
- Land Use Planning (Planning Goal 2) – To establish land use planning process and policy framework as a basis for all decisions and actions related to use of land, and to assure an adequate factual base for such decisions and actions.
- Agricultural Lands (Planning Goal 3) – To preserve and maintain agricultural lands.
- Forest Lands (Planning Goal 4) - To conserve forest lands by maintaining the forest land base and to protect the state's forest economy by making possible economically efficient forest practices that assure the continuous growing and harvesting of forest tree species as the leading use on forest land consistent with sound management of soil, air, water, and fish and wildlife resources and to provide for recreational opportunities and agriculture.
- Natural Resources, Scenic and Historic Areas, and Open Space (Planning Goal 5) – To protect those resources that promote a healthy environment and a natural landscape that contributes to Oregon's livability for present and future generations.

- Air, Water, and Land Resources Quality (Planning Goal 6) – “to maintain and improve the quality of the air, water, and land resources of the state”.
- Areas Subject to Natural Disasters and Hazards (Planning Goal 7) – “to protect people and property from natural hazards”, such as floods, landslides, earthquakes, tsunamis, coastal erosion and wildfires.
- Recreational Needs (Planning Goal 8) – to satisfy citizen and visitor’s recreational needs. Also, to provide for the siting of necessary recreation facilities (including destination resorts), where appropriate.
- Economy of the State (Planning Goal 9) - To provide adequate opportunities throughout the state for a variety of economic activities vital to the health, welfare, and prosperity of Oregon’s citizens.
- Housing (Planning Goal 10) – To provide housing needs for the residents of the state.
- Public Facilities and Services (Planning Goal 11) – “to plan and develop a timely, orderly and efficient arrangement of public facilities and services to serve as a framework for urban and rural development”.
- Transportation Planning (Planning Goal 12) – To develop a coordinated transportation system plan that is safe, convenient, and economical, minimizing reliance on any single travel mode.
- Energy Conservation (Planning Goal 13) – to manage and control lands and associated land uses in order to “maximize the conservation of all forms of energy, based on sound economic principles.”
- Urbanization (Planning Goal 14) – To provide for an orderly and efficient transition from rural to urban land use, to accommodate urban population and urban employment inside urban growth boundaries, to ensure efficient use of land, and to provide livable communities.

While all of the goals will help set the necessary policy framework for the TSP processes, Goal 12 (OAR 660-015-0000 (12)) in particular provides the framework that must be followed as part of the preparation of the updated TSP. Specifically, sections 660-012-0020 through 660-012-0045 outline the requirements and implementation guidance. For compliance with Goal 12, the TSP must provide and encourage a safe, convenient and economic transportation system that is coordinated with urban and rural development.

The TSP must include strategies to reduce reliance on any single travel mode (provide mode choice), facilitate movement of goods and people, develop a system hierarchy for orderly and efficient multimodal travel, and preserve and protect streets and highways for their intended function. The TSP must be coordinated with and consistent with statewide, regional, and local plans.

Transportation System Planning Guidelines (2008)

The TSP Guidelines suggests a logical sequence of planning steps tailored to help smaller, non-MPO jurisdictions in particular, prepare a TSP. One of the planning steps prescribes that jurisdictions include a summary to address how the planning project complies with new regulations, policies, and statutes that have been adopted since the TSP was last adopted, or amended. As such, the remainder of this memorandum summarizes applicable state, regional, and local plans, and frames how the 2005 Prineville TSP relates and complies with these.

Oregon Transportation Plan (2006)

The Oregon Transportation Plan (OTP) is the state's long-range multimodal transportation plan, providing a framework for prioritizing transportation improvements based on future revenue conditions. The OTP is the overarching policy document among a series of plans that together form the state's Transportation System Plan. The plan calls for a transportation system that has a modal balance, is both efficient and accessible, provides connectivity among rural and urban places and between modes, and is environmentally and financially stable.

The OTP outlines the following seven goals, each with associated policies, to guide local, regional and state transportation plans.

- **Goal 1 – Mobility and Accessibility:** Provide a balanced and integrated transportation system that ensures interconnected access to all areas of the state, the nation and the world. Promote transportation choices that are reliable, accessible and cost-effective.
- **Goal 2 – Management of the System:** Improve the efficiency of the transportation system by optimizing operations and management. Manage transportation assets to extend their life and reduce maintenance costs.
- **Goal 3 – Economic Vitality:** Expand and diversify Oregon's economy by transporting people, goods, services and information in safe, energy-efficient and environmentally sound ways. Provide Oregon with a competitive advantage by promoting an integrated freight system.
- **Goal 4 – Sustainability:** Meet present needs without compromising the ability of future generations to meet their needs from the joint perspective of the environment, economy and communities. Encourage conservation and communities that integrate land use and transportation choices.
- **Goal 5 – Safety and Security:** Build, operate and maintain the transportation system so that it is safe and secure. Take into account the needs of all users: operators, passengers, pedestrians and property owners.
- **Goal 6 – Funding the Transportation System:** Create sources of revenue that will support a viable transportation system today and in the future. The goal recognizes that whether or not funds are increased, it is essential to maximize existing resources, invest strategically, consider return on investment and provide equity among rural and urban

areas, equity among income groups and access to transportation options throughout Oregon.

- **Goal 7 – Coordination, Communication and Cooperation:** Foster coordination, communication and cooperation between transportation users and providers so various modes of transportation function as an integrated system. Work to help all parties align interests, remove barriers and offer innovative, equitable solutions.

The OTP, as the guiding document for regional and local TSPs, establishes goals, policies, strategies and initiatives that address the core challenges and opportunities facing transportation in Oregon. The OTP includes modal components that outline recommended standards for various forms of transportation. Table 1-2 identifies the relevant modal elements as well as the year of adoption by the OTC.

Table 1-2 OTP Modal Plan Components

Oregon Transportation Plan Element	Year Adopted
Highway Plan	Originally adopted in 1999 (with subsequent amendments); Access Management and Mobility Standards Amendments in 2011
Aviation Plan	Originally adopted in 2000; the Oregon Aviation Plan was updated in 2007
Bicycle/ Pedestrian Plan	Originally adopted in 1995; Second Part of Plan updated in 2011 and retitled the Oregon Bicycle and Pedestrian Design Guide
Freight Plan	Adopted in 2011
Public Transportation Plan	Adopted in 1997
Rail Plan	Adopted in 2001
Transportation Safety Action Plan (TSAP)	Originally adopted in 1995; the TSAP was updated in 2004 and amended in 2006

2005 TSP Assessment Relative to the OTP

The 2005 TSP is generally consistent with the policies listed within the OTP. The 2005 TSP does include a financial plan inclusive of near-term, mid-term, and long-term funding projections based on various types of revenue streams. The updated TSP will need to address current revenue projections and respond to the need for a financially constrained system.

Oregon Highway Plan (as amended)

The Oregon Highway Plan (OHP) defines policies and investment strategies for Oregon's State highways for the next 20 years. The OHP further refines the goals and policies of the OTP, and serves as the policy basis for implementing the Oregon Administrative Rule (OAR) Division 51, which specifically addresses access to State facilities. The OHP has three main elements:

- A Vision for the future of the State highway system that describes economic and demographic trends in Oregon, future transportation technologies, the policy and legal context of the Highway Plan, and pertinent information on the current highway system;

- Goals, policies, and actions items for: system definition, system management, access management, travel alternatives, and environmental and scenic resources; and
- An analysis of the 20-year State highway needs, revenue forecasts, descriptions of investment strategies and implementation strategies, and performance measures.

The OHP provides policy and investment guidance for local corridor plans and TSPs, but it leaves the responsibility for identifying specific projects and modal alternatives to these more localized plans.

The OHP has been amended several times since its original adoption in 1999, the last amendments were adopted in 2012. These amendments since 1999 have addressed the designation of expressways, changes in mobility standards, designation of Special Transportation Areas, and other changes affecting the classification and standards for highways throughout the state.

Policies in the OHP pertinent to the TSP update are described below.

OHP Goal 1: System Definition

- **Policy 1A, State Highway Classification System** outlines functions and objectives for state highways to serve different types of traffic. Greater mobility is expected on interstate and statewide highways than on regional or district highways. Facility classification is used to guide planning, management and investment decisions regarding state highway facilities.

Figure 1-1 illustrates the existing state highway classifications. OR 126 to the west of Prineville and US 26 through and east of Prineville are *Statewide Highways*. OR 126 west of the O'Neil Highway also includes an *Expressway* designation, increasing its role in intercity high-mobility travel. Within City limits, US 26 is designated as a Special Transportation Area (STA) from milepost 18.24 (Locust Avenue) to 19.38 (Spruce Lane), identifying the increased access role the highway plays in downtown Prineville.

US 26 (Madras-Prineville Highway) is classified as a *Regional Highway*. OR 27 (Crooked River Highway) south of City limits, OR 370 (O'Neil Highway), and OR 380 (Paulina Highway) are classified as *District Highways*.

- **Policy 1B, Land Use and Transportation** addresses the relationship between the highway and development patterns on and off the highway. It emphasizes development patterns that maintain state highways for regional and intercity mobility, and supports compact development patterns that are less dependent on state highways than linear development for access and local circulation. This policy is designed to clarify how ODOT will coordinate with local governments and others to link land use and transportation in transportation plans, facility and corridor plans, plan amendments, access permitting and project development.

- **Policy 1C, State Highway Freight System** identifies the need to balance the movement of goods and services with other uses and the importance of maintaining efficient through movement on major freight routes.

Throughout its length OR 126 is a designated freight route, and US 26 is a designated freight route from its junction with OR 126 at the Prineville “Y” east of the City.

- **Policy 1F, Highway Mobility Targets¹** establishes acceptable levels of mobility for the various levels of state highway facilities, and the condition of the transportation system. With respect to transportation system planning, the highway mobility targets are used to “identify state highway mobility performance expectations and provide a measure by which the existing and future performance of the highway system can be evaluated.” As such, the targets may be used to identify system mobility deficiencies over a planning horizon of at least 20 years.

The OHP’s mobility targets use volume-to-capacity (v/c) ratios as the primary metric. However, where it can be shown that it is infeasible or impractical to meet the targets, local jurisdictions may develop alternative targets in coordination with ODOT and other relevant stakeholders. The OHP states that “providing for better multimodal operations is a legitimate justification for developing alternatives to established OHP mobility targets.”²



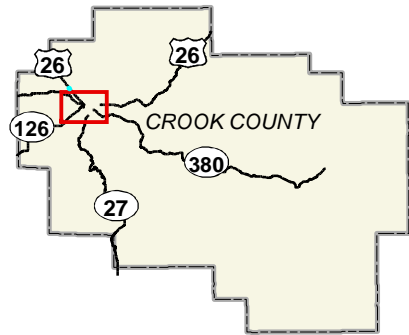

Table 1-5 summarizes the mobility standards that are applicable to the City of Prineville UGB.

¹ The Oregon Transportation Commission reviewed and adopted changes to Policy 1F in December 2011.

² Any OHP Amendments are contingent on Oregon Transportation Commission (OTC) approval.



Highway Classifications

-  DISTRICT
-  REGIONAL
-  STATEWIDE
-  City Boundary
-  UGB

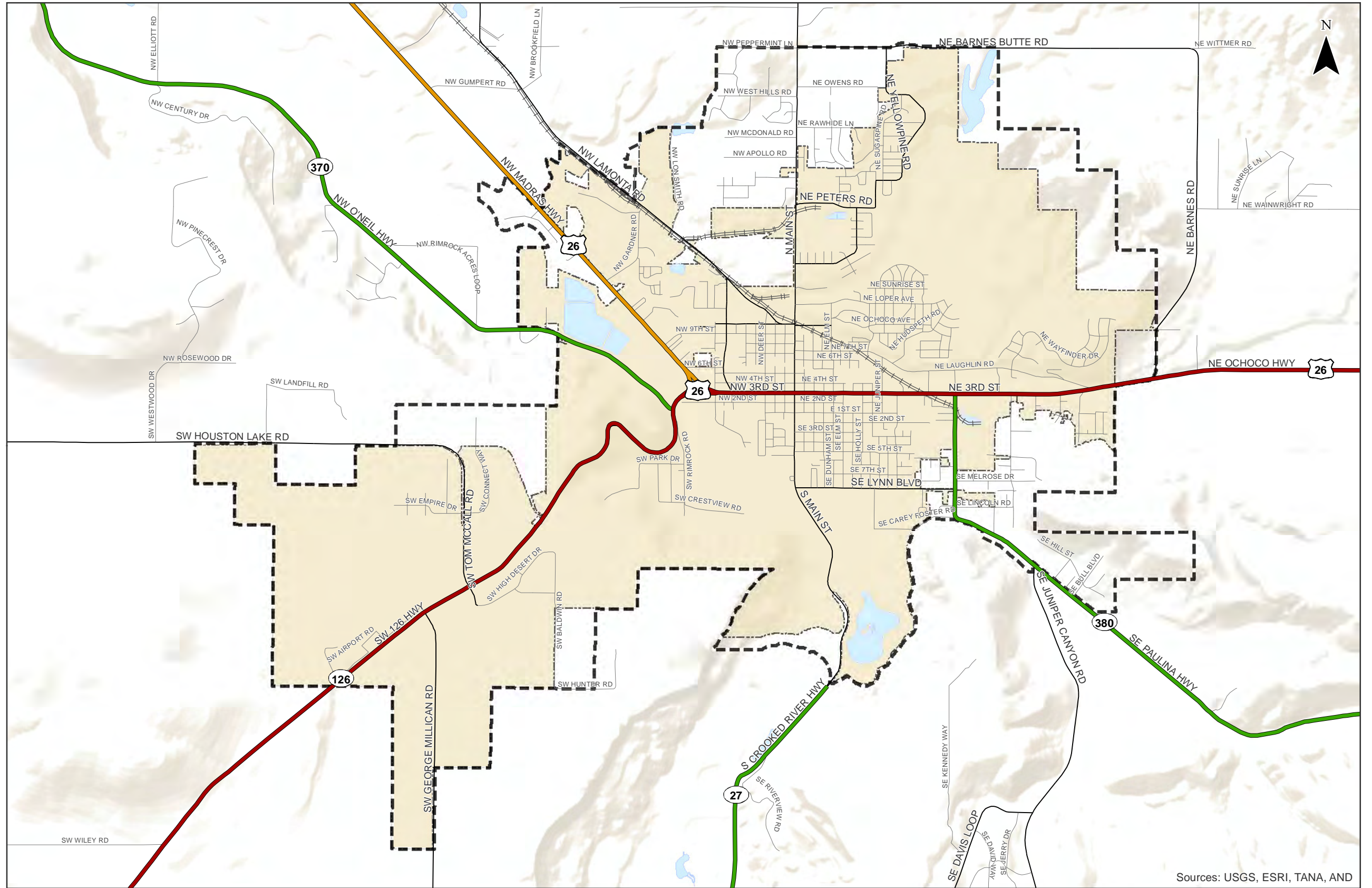

Sources: USGS, ESRI, TANA, AND

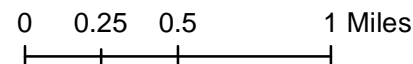

**Existing Highway Classification
City of Prineville, Oregon**

**Figure
1-1**

H:\proj\12221 - Prineville TSP\gis\memo 313-5 Existing Highway Classification.mxd - 11:52 AM 12/30/2012

Table 1-3 Volume to Capacity Ratio Targets for Peak Hour Operating Conditions

Facility Designation	Facility Extents	STA	Non-STAs where posted speed <= 35 mph	Non-STAs where speed > 35 mph but <45 mph	Where speed limit >= 45 mph
Statewide Expressways	OR 126 from Milepost 1.37 (Veteran's Way) to 17.92 (O'Neil Highway)	N/A	0.80	0.80	0.80
Freight Route on a Statewide Highway	All of OR 126	0.90	0.85	0.80	0.80
Statewide (not a Freight Route)	US 26 east of Prineville "Y"	0.95	0.90	0.85	0.80
Freight Route on a Regional or District Highway	US 26 west of Prineville "Y"	0.95	0.90	0.85	0.85
Regional Highways	None	1.0	0.90	0.85	0.85
District/ Local Interest Roads	OR 27 south of City limits, OR 370, and OR 380	1.0	0.95	0.90	0.90

Source: OHP, Table 6, modified for relevance to Prineville facilities and designations.

- **Policy 1G, Major Improvements** requires maintaining performance and improving safety by improving efficiency and management before adding capacity. ODOT coordinates with regional and local governments to address highway performance and safety.

OHP Goal 2: System Management

- **Policy 2A, Partnerships** establishes the need for cooperative partnerships between ODOT and state and federal agencies, regional governments, cities, counties, tribal governments, and the private sector.
- **Policy 2B, Off-System Improvements** helps local jurisdictions adopt land use and access management policies.
- **Policy 2E, Intelligent Transportation Systems** puts emphasis on considering a broad range of Intelligent Transportation Systems services to improve system efficiency and safety in a cost-effective manner.
- **Policy 2F, Traffic Safety** establishes the need to continually improve safety for all highway system users with solutions involving engineering, education, enforcement and emergency medical services.

OHP Goal 3: Access Management

- **Policy 3A, Classification and Spacing Standards** defines access spacing standards for the location, spacing and type of road and street intersections and approach roads on state highways. The adopted spacing standards consider highway classification, posted speed, safety, and operational needs. Revisions to the OHP were adopted by the Oregon Transportation Commission (OTC) on March 21, 2012 to address Senate Bill 264 (2011). The revisions included reductions in spacing standards outside of interchange areas and established unique standards based on highway volume.

Access management spacing standards for highway segments with AADT of 5,000 vehicles or less are shown in Table 1-4.

Table 1-4 Access Management Spacing Standards for Highway Segments

Route Name	Description	Functional Classification	2012 AADT	Posted Speed (mph)	Access Spacing Standard
US 26 Ochoco Hwy Madras Hwy	East of Prineville "Y" City Limits to Prineville "Y"	Statewide Highway ¹ Regional Highway	>5000 >5000	30 55/40/30	500 1,320/800/500
OR 27, Crooked River Hwy	Outside City Limits	District Highway	<5000	45	360
OR 126, Ochoco Hwy	Entire Segment	Statewide Highway ²	>5000	55/45/30	2,640/2,640/500
OR 370, O'Neil Hwy	Entire Segment	District Highway	<5000	55	650
OR 380, Paulina Hwy	Entire Segment	District Highway	<5000	35/45	250/360

¹ Special Transportation Area from Milepost 18.24 to 19.38

² Expressway from Milepost 1.37 (Veteran's Way) to 17.92 (O'Neil Highway)

- **Policy 3D, Deviations** establishes general policies and procedures for deviations from adopted access management standards and policies.

OHP Goal 4: Travel Alternatives

- **Policy 4A, Efficiency of Freight Movement** establishes the need to maintain and improve the efficiency of freight movement on the state highway system and access to intermodal connections. The State seeks to balance the needs of long distance and through freight movements with local transportation needs on highway facilities in both urban areas and rural communities.
- **Policy 4B, Alternative Passenger Modes** establishes the need to advance and support alternative passenger transportation systems where travel demand, land use and other factors indicate the potential for successful and effective development of alternative passenger modes.

2005 TSP Assessment Relative to the OHP

The Oregon Highway Plan was and will continue to be relevant in the assessment of ODOT facilities in the current and updated TSPs. The 2005 TSP includes a Streets and Highways Element that defines the street functional classification, and specifies classifications within the

City of Prineville roadway network. State mobility targets for the existing and no-build conditions will be developed based on the facility designations and the adopted mobility targets contained within the OHP.

Oregon Aviation Plan

The Oregon Aviation Plan (OAP) is a comprehensive evaluation of Oregon's aviation system, thus providing a systematic approach to meeting improvements and development strategies recommended within the Plan. The plan looks beyond the traditional state aviation system planning elements by assessing the following three areas:

- Existing aviation infrastructure;
- The economic benefit of the aviation industry;
- National importance and state significance of each airport.

The Prineville Airport is classified as a local general aviation airport within the OAP which means that it primarily supports local air transportation needs and special use aviation activities. The OAP suggests that the Prineville Airport install low intensity taxiway lighting, rehabilitate runway pavement, rehabilitate terminal building, construct hangars, and install automated weather reporting equipment.

2005 TSP Assessment Relative to the OAP

The 2005 TSP includes an Air Service Element, which recognizes that the Prineville Airport is a part of the OAP. In addition, the Prineville Airport has a Master Plan which considers and addresses OAP recommendations.

Oregon Bicycle/Pedestrian Plan

The Oregon Bicycle and Pedestrian Plan is divided into two parts, the Policy and Action Plan and the Bicycle and Pedestrian Design Guide. The first part was adopted in 1995, while the second part was updated in 2011. The Plan outlines key characteristics that should be considered related to accommodating bicycles and pedestrians when planning and designing state facilities. The Oregon Bicycle and Pedestrian Plan does not require specific standards for non-ODOT facilities. However, the plan recommends that land use patterns, transportation system layout, public transportation system design, and other planning related issues consider the impact to bicycle and pedestrian users and to the bicycle and pedestrian system as a whole. To this end, the plan provides specific design recommendations to support bicycle and pedestrian travel.

The Bicycle and Pedestrian Plan recognizes the role that safe, attractive, convenient, and easy to use bicycle and pedestrian facilities play in the provision of the state and local transportation systems. The plan includes seven chapters that guide the planning and design of on-road bikeways, restriping, bicycle parking, walkways, street crossings, intersections, and shared use paths.

2005 TSP Assessment Relative to the Oregon Bicycle and Pedestrian Plan

The existing TSP contains a Bikeway Plan element and a Pedestrian System element that address bicycle and pedestrian system needs, goals and policies, respectively. The TSP update will include revised inventory information, incorporate Safe Routes to School program recommendations, seek to better connect pedestrian attractions such as parks and trails with Prineville residents, and include specific technical analyses relative to the bicycle and pedestrian plan recognizing the important role that these modes play in the provision of a sustainable, safe, and efficient transportation system.

Oregon Freight Plan

The Oregon Freight Plan was adopted in June 2011 and provides a 25-year planning vision. The purpose of the Oregon Freight Plan (OFP) is to “improve freight connections to local, state, regional, national and global markets in order to increase trade-related jobs and income for Oregon workers and businesses.” The OFP addresses challenges facing the freight system, including system operation and development, safety, communications, environmental considerations and funding.

While the freight plan serves as a modal element of the Oregon Transportation Plan, the OFP includes elements of several modes including marine, aviation, rail, pipeline, and truck transport. Key routes and transfer sites are presented and summarized within the plan.

Strategic freight corridors identified by the Central Oregon Area Commission on Transportation (ACT) include: US 97, US 26, US 20, US 197, BNSF/UP rail corridor, the City of Prineville Railway shortline, and the Redmond and Bend airports.

2005 TSP Assessment Relative to the OFP

The 2005 TSP includes a Freight Mobility Element which identifies improvements to the local street network to increase the efficient movement of freight and to decrease traffic impacts to local streets. The TSP Update will also identify improvements to the street network in order to improve freight mobility.

Oregon Public Transportation Plan

As a modal element of the OTP, the Oregon Public Transportation Plan provides a long range vision for the public transportation system in Oregon. This system incorporates public and private transportation providers and is comprised of ridesharing and volunteer programs, taxi and minibus service, and intercity and intracity bus and passenger rail services. The Public Transportation Plan outlines three primary goals and associated policies and strategies that guide public transportation through the year 2015. In recognition of limited resources, the Plan prioritizes elements that deliver service to “those Oregonians most dependent on the public transportation system (seniors, disabled, low-income, and youth).”

2005 TSP Assessment Relative to the Public Transportation Plan

The City of Prineville falls within the jurisdictional category of cities with a population between 2,500 and 25,000 and is, therefore, not required to include a public transportation plan in their local transportation system plans (TSPs). The 2005 TSP does include an inventory of public transportation facilities in the city.

The TSP update will not include a Public Transportation Plan, but will update the inventory of public transportation facilities specifically related to regional transit services being provided through Cascades East Transit and the siting of park-and-ride facilities. These facilities and services were not present when the 2005 TSP was prepared, and support regional trip making to the larger urban areas within Central Oregon.

Oregon Rail Plan

The Oregon Rail Plan was adopted as the railway modal element plan into the Oregon Transportation Plan in 2001. The document is divided into three separate parts:

- Part 1: Describes the rail policies and planning process
- Part 2: Describes the freight element
- Part 3: Describes the passenger element

Within Part 1, the Oregon Rail Plan meets mandatory federal and state planning requirements related to the management and maintenance of the railway system. This section also provides the general management goals for State rail facilities.

Part 2 is particularly relevant to Prineville given the existing rail infrastructure. The Oregon Rail Plan provides the following benefits associated with railways serving industrial lands.

Because of the continuing dependence of many producers upon rail services, communities in their land use planning should attempt to ensure that a sufficient quantity of land with convenient access to rail service is planned and zoned for industrial development. There are several reasons why industrial parks and other industrially zoned property should have rail access:

- 1. Railroads tend to be more energy efficient than trucks and, therefore, can make better use of available energy resources.*
- 2. Some commodities and products, especially those that are large, bulky, low valued, oversized, or not transportable over highways can be transported only by, or most efficiently by, railroad.*
- 3. Access to rail service enable shippers to have a wider choice of transportation options, thus having a better bargaining position when negotiating rates with rail and truck carriers. While the initial occupant or occupants of a particular site or industrial park may not require rail service, subsequent occupants may.*
- 4. Rail service enables delivery of goods in periods of emergency, strike or inclement weather when trucks cannot operate.*

5. A railroad right-of-way may take less space than roads, and a railroad spur track may handle more volume in less space than could be done with trucks.

The Oregon Rail Plan further describes the implications of rail service with respect to zoning, noting that industrial lands served by rail are more valuable than those without; whereas residential lands near railways are less valuable. Prineville was noted in the plan as an especially competitive given its location by more than a single major railroad. The plan also notes that communities with access to short lines have an advantage in attracting business that need frequent switching or rail car movements.

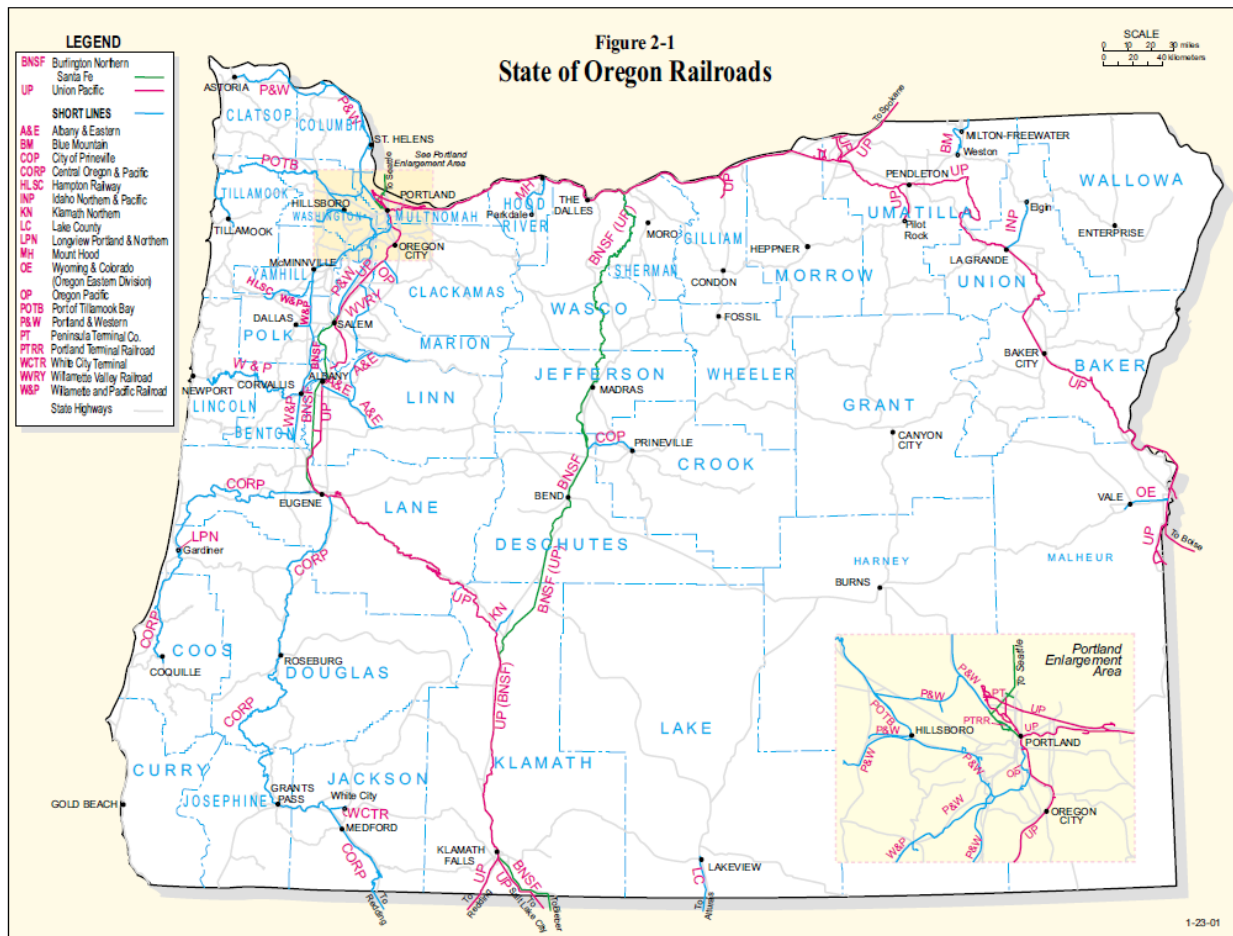

Exhibit 1-2. State of Oregon Railroads.

Limited information related to the City of Prineville (COP) Railway is also summarized in the plan; it was noted that COP manages 18.35 miles of railway that connects to the Burlington Northern Santa Fe (BNSF) mainline, as shown in Exhibit 1-2. The plan also notes that the railway is maintained at Federal Railroad Administration (FRA) Class 2 (25 mph maximum speeds) with no weight or dimensional restrictions.

Passenger service along the COP has been discontinued since 2001 so the Passenger rail section of the Oregon Rail Plan no longer applies to Prineville.

2005 TSP Assessment Relative to the Oregon Rail Plan

The interaction and more recent investment in City infrastructure (and at the Prineville Junction north of Redmond) have improved the City of Prineville Railway. Consideration of the interaction and safety at rail crossings, access to loading areas for trucks, and land use compatibility are all components that will need to be addressed within the Prineville TSP to preserve the leverage the rail infrastructure and attract industry.

Transportation Safety Action Plan

The Transportation Safety Action Plan (TSAP) serves as the state of Oregon's Strategic Highway Safety Plan (SHSP), as required by federal law. The TSAP lays out a set of actions to provide a safer travel environment. The set of actions are prioritized based on those factors that contribute to the greatest number of transportation-related deaths and injuries. The TSAP identifies impaired driving, not using safety constraints, speed, and inexperience as Emphasis Area Actions that should be implemented by the year 2020. Beyond identifying actions to decrease the overall number of fatalities and injuries related to transportation, the TSAP also serves as a guide to prioritize investments.

2005 TSP Assessment Relative to the TSAP

Improvement to safety was a noted criterion when identifying new improvement projects in the 2005 TSP. The 2005 TSP identifies 18 street improvements to address specific capacity deficiencies and safety needs. The street improvements are categorized based on priority level. The TSP Update will provide a more in-depth assessment of safety needs within the Prineville UGB to address changes in crash patterns and develop a revised set of mitigating projects and strategies.

OAR Chapter 734-051 (Division 51)

Commonly referred to as Division 51, ODOT has adopted OAR 734-051 to establish procedures and criteria to govern highway approaches, access control, spacing standards, medians and restriction of turning movements in compliance with statewide planning goals, in a manner compatible with acknowledged comprehensive plans and consistent with state law and the OTP. Any new street or driveway connections, as well as any changes to existing street or driveway connections, to state roads within the TSP study boundary must be in compliance with these rules.

OAR 734-051 policies address the following:

- How to bring existing and future approaches into compliance with access spacing standards, and ensure the safe and efficient operation of the highway;
- The purpose and components of an access management plan; and;
- Requirements regarding mitigation, modification and closure of existing approaches as part of project development.

Access management standards adopted by ODOT and applicable to Prineville's TSP are summarized in Table 1-4. OHP Policies 3A and 3C establish access management objectives for state highways and interchange areas based on facility type and set standards for spacing of approaches. These standards have also been adopted as part of OAR 734-051, which provides the regulatory basis for implementation.

Senate Bill 264 was passed in June 2011, and amended temporary rules that took effect in May 2012. The bill directs ODOT to develop proposed legislation to "codify, clarify and bring consistency to issuance of access based on objective standards for highway segments where the annual amount of daily traffic is 5,000 vehicles or fewer." The temporary rules are reflected in the OHP amendment to the 2011 Access Management Standards.

2005 TSP Assessment Relative to the OAR 734-051

The 2005 TSP outlines the guiding principles used in the adoption of new access management standards consistent with OAR 734-051 and the 1999 OHP. Table 7-2 in the 2005 TSP summarizes the street design guidelines and includes access management standards based on the guiding principles. The TSP Update shall incorporate the amendments to OAR 734-051 through the adoption of Senate Bill 264 when establishing revised street design guidelines.

ODOT Highway Design Manual

An update to the Highway Design Manual (HDM) was released in 2012, and includes ODOT standards and procedures for the location and design of new construction, major reconstruction, and resurfacing, restoration or rehabilitation (3R) projects. The HDM is used for all projects that are located on state highways. The following matrix in Table 1-5 shows which design standards are applicable for certain projects based on project type, and whether the project pertains to a state route.

Table 1-5 Design Standards Selection Matrix

Project Type	Roadway Jurisdiction	
	State Highways	Local Agency Roads
Modernization/ Bridge New/Replacement	ODOT 4R/ New Urban	AASHTO
Preservation/ Bridge Rehabilitation	ODOT 3R Urban	AASHTO
Preventive Maintenance	1R	N/A
Safety- Operations- Miscellaneous/ Special Programs	ODOT Urban	AASHTO

Source: 2012 HDM, Table 1-1

In addition, the HDM identifies more stringent capacity standards than those within the Oregon Highway Plan when developing new highway facilities, to further leverage the investment in infrastructure.

2005 TSP Assessment Relative to the Highway Design Manual

The design standards in the HDM will be integrated into the detailed design and engineering that will occur for projects once they are incorporated into the TSP Update and are programmed as part of the City's Capital Improvement Program (CIP) for transportation.

Statewide Transportation Improvement Program (2012-2015)

The Statewide Transportation Improvement Program (STIP) is Oregon's four-year transportation capital improvement program that identifies the funding for, and scheduling of, transportation projects and programs. It includes projects on the federal, state, county and city transportation systems, multimodal projects (highway, passenger rail, freight, public transit, bicycle and pedestrian) and projects in the National Parks, National Forests and Indian tribal lands. Oregon's STIP covers a four-year construction period, but is updated every two years in accordance with federal requirements. The currently approved program is the *2012-2015 STIP*. The *Draft 2015-2018 STIP* is currently under development, including potential improvements at the Tom McCall intersection with OR 126.

The *2012-2015 STIP* should be reviewed for projects to consider during the development of Prineville's TSP Update for complementary or conflicting traffic impacts. The Approved 2012-2015 STIP identifies one project within the City of Prineville, as summarized in Table 1-6.

Table 1-6 2012-2015 Approved STIP Projects within the City of Prineville

Section	Total Cost	Description	Status	Year (FFY)
OR126 @ Prineville Grade	\$2,000,000	Pavement preservation with center line rumblestrips & durable striping	Construction	2014

House Bill 3379 Administrative Rule

House Bill (HB) 3379, which passed during the 2009 legislative session, directed the Oregon Transportation Commission (OTC) to adopt an administrative rule to establish an application process that local governments can use for economic development projects if they are not able to meet the funding or timing requirements of the Transportation Planning Rule (TPR) related to state highways. The administrative rule describes how a local jurisdiction may work with the OTC and ODOT to do one of the following:

- Apply for a time extension to meet TPR requirements;
- Submit a plan proposing alternative methods of funding that will meet the standards adopted by the OTC;
- Apply to adjust traffic performance measures during an interim period prior to completion of construction of the proposed development; or,
- Apply to allow various types of traffic performance measures other than volume to capacity ratios (v/c).

The OTC adopted the Administrative Rule in December 2010 and provisions pertaining to the above can be found in OAR 731-017-005 through -0055.

REGIONAL PLANS

OR Highway 126 Corridor Facility Plan

The OR Highway 126 Corridor Facility Plan assesses the highway segment between the western Crook County boundary and the Prineville “Y” junction with US 26. The Plan establishes a long-term vision for OR Highway 126 and provides a series of strategies aimed at addressing corridor congestion, improving safety, supporting economic development and expected population growth in Crook County and Prineville, and serving statewide mobility needs.

2005 TSP Assessment Relative to the OR Highway 126 Corridor Facility Plan

The 2005 TSP was adopted before the OR Highway 126 Corridor Facility Plan was developed and adopted. The TSP Update will incorporate the recommendations and improvements within the City of Prineville UGB and determine their applicability on a system-wide level. The corridor plan did not make specific recommendations within the Prineville city limits between the O’Neil

Highway and the City core, as the implications of these on 3rd Street (OR 126/US 26) had a considerable impact on the downtown that was determined to be better addressed as part of City (rather than regional) plans. Accordingly, specific items to be addressed within the TSP include:

- Adoption of a plan for Tom McCall and Millican Road;
- Realignment options for the O’Neil Highway, or interim treatments; and
- Review of options at the Prineville “Y” and how these options would integrate with 3rd Street.

Cascades East Transit Regional Transportation Plan

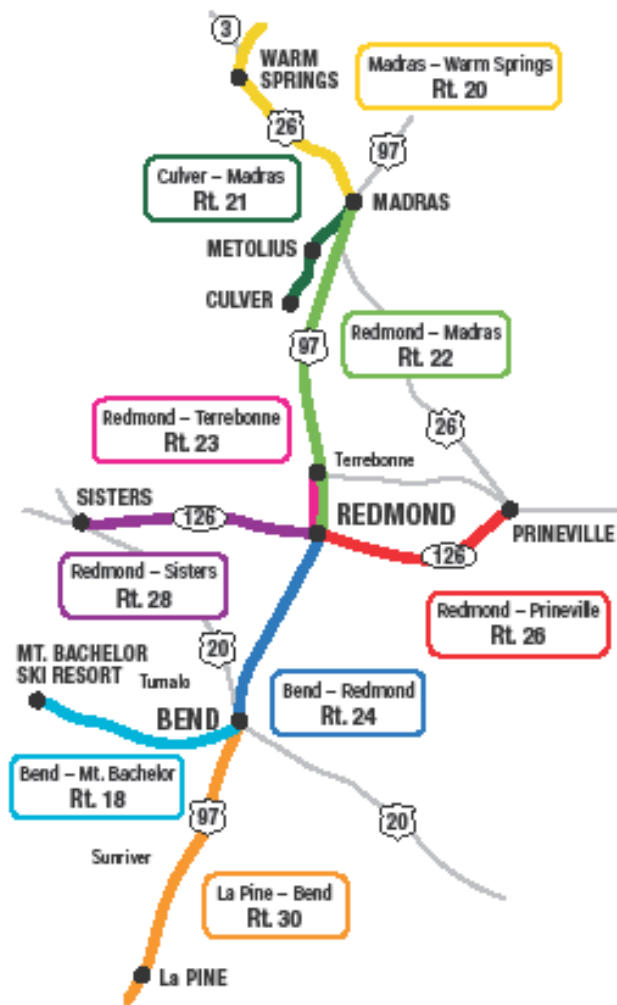

Central Oregon Intergovernmental Council (COIC) is facilitating the development of regional transit plans that will encompass service throughout Deschutes and Jefferson Counties within Central Oregon. Cascades East Transit (CET), which provides regional services to cities shown in Exhibit 1-3, will operate the service. The dispersed services that had been provided prior to 2008 were inefficient to transfer between services with separate fare structures.

Key elements of the ongoing CET regional transportation plan include the following:

- Development of fixed route transit service in Redmond
- Integration with tourist/event services
- Establishment of regional park and ride facilities
- Partnerships with schools, health care, and Confederated Tribes of Warm Springs

Exhibit 1-3. Regional CET service boundaries.

2005 TSP Assessment Relative to CET Regional Transportation Plan

Fixed route transit service was not established within Central Oregon when the 2005 TSP efforts were completed. The provision of regional transit and routes to connect pedestrians, bicyclists, and motorists with these services will help to relieve the congested OR 126 corridor and provide modal options. The CET Regional Transportation Plan is currently in progress so the COIC project manager will serve as a technical advisory committee member to ensure coordination between efforts.

Central Oregon Rail Plan

The Central Oregon Rail Plan was developed “between 2007 to 2009 to address various rail related safety, congestion, freight mobility, and economic development issues for Central Oregon.” One of the primary concerns identified in the plan is the need “to make strategic investments to avoid eventual loss of rail service by Class 1 haulers, and the significant economic and livability impacts this would have on all of the communities” in Central Oregon. Two of the three solutions listed to address this issue directly involve the City of Prineville Railroad (COPR) and intermodal transfer facilities:

- Take advantage of and maximize opportunities with the area’s shortline railroad, COPR, including industrial sites along the line, and freight terminal options such as the Prineville Freight Depot and at the COPR interchange with BNSF at *Prineville Junction*.
- Seek agreement by shippers in Central Oregon to use a single designated intermodal complex.

The Central Oregon Rail Plan seeks to address two general issues: rail crossings and freight mobility. Per the plan, at-grade crossings in Central Oregon cities can contribute to safety and congestion issues. Freight mobility, on the other hand, “is about economics, preserving and enhancing rail freight mobility.”

The plan indicates that the long term (50-70 year) vision is “to eliminate the at-grade crossings, either by bridge crossings or by closures.” However, the high cost of the needed infrastructure makes this challenging to implement in the short term (20 years). The stated goal is to gradually phase out at-grade crossings over the planning period, beginning with those deemed to be of greatest significance on a regional level. The plan specifically identifies seven “high priority” crossing locations to eliminate, none of which are in Crook County.

The plan states the “ideal vision for Central Oregon” in regard to freight mobility “is to improve, enhance, and sustain freight mobility by use of rail services.” Stating the primary challenge as the infeasibility of “individual shippers (with individual commodities) located on the mainline, the plan states the following twofold goal:

- Maximize the existing rail network.
- Develop large land parcels for rail-served industries.

The plan specifically identifies maximizing use of the City of Prineville Railroad and intermodal transfer facilities as “an opportunity to improve freight mobility.” Finally, the plan highlights the City of Prineville Railroad in several of the implementation statements, including the following:

- “Take advantage of and maximize opportunities with the area’s shortline railroad, COPR. Secure long-term efficient and competitive rail service by siting non-unit train, rail-served industries along the COPR. Sites served by a shortline railroad with access to both the BNSF and UP are exceedingly rare and desirable from a competitive standpoint. The highest ranked sites . . . include land at: Prineville Junction (Deschutes County), Crook County Heavy Industrial Zone, [and] Northwest Industrial Park (Prineville).”
- “Prioritize and encourage support of trucking freight to COPR Freight Depot for transfer to rail mode, for the shippers of less than one unit train volumes currently located on the mainline or new shippers locating in the vicinity of the mainline.”
- “Having one pick-up and drop-off location in Central Oregon [for the BNSF line], rather than several, will ensure that the mainline velocity and capacity are not compromised over the long term.”
- “Regardless of which recommended strategies COACT is able to or decides to implement, the COPR is Central Oregon’s best hope for assuring we maintain access to the national rail network.”

COUNTY PLANS AND POLICIES

Crook County Parks and Recreation District Master Plan (2007)

The Crook County Parks and Recreation District (CCPRD) Master Plan was created to “guide the acquisition and development of recreation programs, parks, facilities, and trails to accommodate the needs and desires of the total community.” Key findings of this plan include:

- Small, neighborhood parks, within walking distance of residents, are needed in new and existing neighborhoods.
- The development of an interconnected trail system is a high priority for the community.
- Parks, open spaces, trails, and greenways are an important part of the character of Prineville. The park, open space, trails, and greenway system should be maintained and expanded.

Within the plan there is limited discussion of trails as a transportation need, rather the plan highlights the recreational benefits. One relevant project for the TSP update is the Ochoco Creek Bike Path, which is described as a 2.4 mile “paved surface separated from vehicles for pedestrian and bicycle use” and indicates that the “path needs resurfacing & repair.”

The CCPRD Master plan includes the following 20-year recommendations relevant to transportation:

- Plan for an additional 7 miles of pathways and 7 miles of trails.

- Work with developers to assure that park lands and trail connections are developed with new development.
- Continuously look for opportunities for land dedication, purchase and/or establishment of easements for greenway parks and trails in areas of existing and new development.

The plan also includes several recommendations related to specific properties on which there may be opportunities to expand or provide connections to the trail system:

- Land located on either side of NW Lon Smith Road is an area identified in the City's comprehensive plan to be rezoned from industrial to residential. The District should work with the City and future developer(s) to create community and neighborhood parks and trails in this area.
- Lands south of Barnes Butte are proposed with approximately 2,500 residential lots. The District is currently working with the developer for potential parks and trails.
- Colson and Colson are proposing a development of approximately 1,000 residential lots along the Crooked River, south of the City. The District should review development applications for neighborhood parks, trails, and trail connections.
- Kennedy Development is proposing a residential development west of Juniper Canyon Road, north of Highland Acres. This development will require neighborhood parks and trails.
- The Melrose area in the southeast portion of the City has potential for redevelopment with a neighborhood park. The District should review the area for park development and trail opportunities.
- Crystal Springs is a proposed development with 200 to 300 residential lots northeast of the Melrose area. The District should also evaluate this area for park development and trail opportunities.

The strongest single statement in the plan related to the development of the trails is the following:

"The District should strive to create a continuous trail and open space greenway system adjacent to Ochoco Creek, McKay Creek, and the Crooked River. These greenways should be developed with a system of trails and parks that connect to other trails, parks, and neighborhoods in the District."

The Plan includes a Trail Vision Map which depicts existing and future trails along each of the water courses listed above as well as up into the rimrock both to the east and west of the city.

Crook County Comprehensive Plan (Last Amended 2002)

The Comprehensive Plan is a statement of public policy for the guidance of growth, development, and conservation of resources within the County. There is little background information in the Comprehensive Plan related to the transportation system within the Prineville UGB and there are no policies that directly relate to the function or design of streets within

Prineville's transportation system. However, policies related to growth and transportation planning are relevant to future planning for the UGB.

The Comprehensive Plan describes the dynamic tension between rural and urban land uses and the County's role in providing a planning framework that both preserves agricultural land and provides for the smooth transition of rural to urban use. The policy framework set out in Chapter I is related to the urban growth boundary (UGB) and urbanization. These policies relate to the timing, location, and funding of public facilities. Pertinent to the TSP Update process, particularly within the areas of the UGB outside of city limits, policies specifically address the role of transportation facilities in supporting or restricting growth. Chapter I includes the following implementation guidelines:

1. *"The type, location and phasing of public facilities and services are factors which should be utilized to direct urban expansion.*
2. *The type, design, phasing and location of major public transportation facilities (i.e. all modes: air, rail, mass transit, highways, bicycle and pedestrian) and improvements thereto are factors which should be utilized to support urban expansion into urbanizable areas and restrict it from rural areas.*
3. *Financial incentives should be provided to assist in maintaining the use and character of lands adjacent to urbanizable areas.*
4. *Local land use controls and ordinances should be mutually supporting, adopted and enforced to integrate the type, timing and location of public facilities and services in a manner to accommodate increased public demands as urbanizable lands become more urbanized."*

The Plan highlights "urban development priority factors" that relate to the costs of providing transportation, provide for the efficient extension of the system, and providing access to an existing improved arterial or collector.

Other policies related to future growth and impacts to the transportation system include those addressing employment land. The first policy under the Industry Chapter is to "protect existing industrial development and establish the Airport and Railroad Industrial Sites as a high priority for industrial expansion." The second policy is to direct growth to the "airport vicinity between Houston Lake Road and the Redmond Highway."

The following Air, Water and Land Resource policy also relates to the transportation system:

- "6. Provide for bicycling and walking as viable transportation alternatives and provide facilities for such (Transportation Element, Chapter IV)."*

The Recreation chapter supports this policy with a statement that there is a need in the greater Prineville area for bicycle paths; the Transportation chapter includes several policies relating to the City of Prineville's objective to encourage pedestrian and bicycle movement as a safe, feasible alternative to the automobile for the metro area.

Crook County TSP

The 2005 Crook County Transportation System Plan (County TSP) addresses the County's anticipated transportation needs through the year 2025. The long-range plan is intended to serve as a guide for managing existing County transportation facilities and developing transportation facilities to meet existing and future needs.

Transportation Goals and Policies are found in Section 2.0. Under Goal 1, Mobility, County policies and describe four phases of transportation improvements along OR 126, address Prineville Airport access onto OR 126, and reference the County's intergovernmental agreement (IGA) with ODOT regarding the Powell Butte Highway jurisdictional transfer and associated improvements along OR 126. These are summarized below.

- Policy 1.11: "Future transportation improvements along OR 126 shall occur by a four phase process. These phases are: 1) passing lanes every 3-5 miles; 2) continuous four lane section; 3) grade separate the higher volume road intersections with interchanges and/or overpasses; 4) full access control with median barriers, frontage roads. Depending on the intersection, some elements of Phase 3 and Phase 4 can be intermixed. The goal of this four-phase approach is to incrementally improve an existing two lane rural highway, culminating in a four-lane facility with grade-separated interchanges and frontage roads. The timing of improvements may be tied to volume-capacity (v/c) ratios, levels of service, crash rates per million vehicle miles, reducing types of crashes, or other performance standards."
- Policy 1.12: "Any transportation changes near the Prineville Airport must consider the current Prineville Airport Layout Plan. Crook County does not necessarily support the conclusions of the 1998 City of Prineville Transportation System Plan in regard to their preferred option to improve the airport industrial area access to OR 126. The City of Prineville is in the process of updating their transportation system plan and should closely coordinate the airport industrial area access issues to OR 126 with Crook County since part of the affected facility and traffic is on county roads. The ultimate solution should adequately connect Tom McCall Road and Millican Road together in an efficient manner with one interchange connection to OR 126."
- Policy 1.13: "Crook County recognizes that the agreements with ODOT in regard to the Powell Butte jurisdictional transfer and the improvements along OR 126 provide the framework to implement the transportation improvements along those corridors. Specifically, the agreement addresses the planning and funding of the Powell Butte Highway interchange with OR 126 and the eventual four-lane widening of OR 126 from Redmond to Prineville. In addition, the IGA addresses the process to develop the Tom McCall Road/Millican Road interchange with OR 126."

Goal 7 outlines policies to encourage and maintain multi-jurisdictional coordination amongst agencies and organizations with Crook County, including the City of Prineville and ODOT.

- Policy 7.3: "Work with ODOT and the City of Prineville in establishing cooperative transportation improvement programs and schedules."

- Policy 7.6: “Crook County shall maintain an urban growth boundary (UGB) management agreement with the City of Prineville. This agreement shall be the basis to manage facilities outside the Prineville city limits but within the UGB as well as to eventually transfer facilities from Crook County to the City of Prineville when annexations occur.”
- Policy 7.8: “Crook County shall coordinate with the City of Prineville in the development and update of its transportation system plan (TSP). Crook County shall also coordinate with the City of Prineville in the development of the city’s TSP. Consistency between Crook County’s and City of Prineville’s TSPs shall be sought.”

The Existing Conditions section of the TSP lists OR 126 and US 26 as two of the five state highways that form the “backbone of Crook County’s street system (p. 3-6).” The TSP describes the facilities, and includes their functional classifications and general roadway geometries. Table 3-1 in the Crook County TSP provides the posted speeds and roadway design for six specific segments of OR 126 and four specific segments of US 26, from Prineville to the County line.

Several Prineville area projects are identified in the County TSP and are listed below:

- US 26/Harwood signal (completed)
- Crooked River Bridge (completed)
- Millican Road Interchange with OR 126
- Crestview Road Extension across Crooked River to OR 27
- Roundabout at Knowledge/high school entrance
- Add bike lanes and sidewalks to Lynn Boulevard
- New Millican Road, alternative truck route, from OR 126 to US 20
- New Davis Road connection between Juniper Canyon and OR 27, south of Prineville

2005 TSP Assessment Relative to the Crook County TSP

The 2005 Crook County TSP does not reflect amendments the City has made to their current transportation system plan, nor does it include an account of the recent OR 126 corridor study. As the plan was prepared when economic projections were strong, the recommendations reflect conditions that have subsequently become more constrained.

Goals, priorities, and the interaction within boundary areas between County and City facilities will be key components of the plan that will need to be carried into the Prineville TSP update. The update process should also include a specific account of Juniper Canyon and its emergency access needs (alternatives to OR 126).

CITY PLANS AND POLICIES

City of Prineville Urban Area Comprehensive Plan (2007)

The Prineville Urban Area Comprehensive Plan (Plan) “is a dynamic and inspirational guide for directing and managing growth in the community.” It is a “value driven” plan through which community goals become the foundation for decision-making on a variety of levels within the local government.” The following highlights chapters from the Comprehensive Plan that contain information, goals or policies relevant to transportation planning in the UGB.

Chapter 1, Community Characteristics

This chapter highlights the history of Prineville as well as current characteristics of the community. It includes a history of the Prineville Railroad, the last civically owned railroad in the country. The railroad was constructed in 1916 with a bond voted on by the citizens after the major railroads had decided to bypass Prineville. The railroad has been a key part of the community’s history, culture and economy over the past century, specifically in its relation to the lumber mill industry. Decline in that industry has threatened the operation of the Prineville Railroad over the past couple decades; however, renewed efforts by the City have protected this resource as a viable freight option for local businesses. The Prineville Railroad, and associated freight depot, are seen by the community not only as a historical treasure but also as a major component of the current and future economy, community identity, and freight transportation system.

Chapter 1 also indicates that the city “has a high concentration of trucking/ground transportation companies” and points out that the wide streets “testify to a value of open spaces and easy vehicular and large transport access.” Ensuring a strong trucking industry complements the city’s efforts to promote rail freight by offering local businesses more freight options. Protecting the viability of the trucking industry will be a key consideration in the TSP update.

The following policy excerpts in Chapter 1 are relevant to the TSP update.

- Neighborhoods shall contain employment/shopping/service opportunities located in areas that can be served by transit and easily accessed by residents in the neighborhood.
- A downtown revitalization program shall be researched and developed to include incentives and other features desired by the community. These may include: delivery systems that do not negatively affect pedestrians, shoppers, and traffic flows; pedestrian amenities and improved crossing corridors; and reserved on street parking spaces for disabled, public transportation, maintenance and emergency services.

Chapter 2, Urban Land Use and Zoning Designations

This chapter discusses residential, commercial and industrial zone values and policies as well as multimodal transportation, sustainability and growth management. The following policy excerpts in Chapter 2 are relevant to the TSP update:

- Residential zones shall promote walk-ability and connectivity to adjacent neighborhoods, open spaces, parks and commercial nodes.
- Commercial zones should provide adequate opportunities to locate and operate businesses so Prineville can be as self-sufficient as possible without requiring citizens to make excessive vehicle trips to other communities.
- The downtown business commercial core area is a key feature of Prineville and should be enhanced to provide a draw for all citizens and visitors alike. Convenient and plentiful transportation and parking opportunities are necessary for the success of the downtown area.
- Industrial areas that are served by adequate community transportation, convenient connections to highway access, workforce housing, water, and sewer, communication, power, and gas systems will have a competitive advantage in the Central Oregon region.
- Industrial areas that provide mixed-use opportunities and service uses for employees can reduce excess vehicle trips and community subsidy.
- Larger width streets are appropriate in industrial areas.
- Industrial areas near local airports can enhance commerce and attract compatible aviation activities and industries.
- Industrial areas near city railroad facilities can enhance commerce and attract supportive activities and industries. Industrial uses should be encouraged to use railroad facilities for transportation of heavy freight, thus reducing vehicular traffic on roadways.
- Alternate mode transportation opportunities should be expanded as part of new development and redevelopment proposals.
- The topography of the Prineville community is mixed. The outlying areas contain various landforms that necessitate the creation of separate residential areas in-between the rimrock/plateau features. These areas will need to be developed as “complete neighborhoods” to provide proper service levels, infrastructure systems, reduced vehicle miles traveled, and other designs/devices that support alternative mode use.
- The Prineville community desires to move towards creating land use patterns that support a multi-modal transportation system. This technique will seek to connect all areas of the community resulting in greater sustainability of all resources in spite of the challenges created by the varied topography.
- Higher density residential areas that are within walking distance of shopping, jobs, open space, recreation, and transit services will use land efficiently without sacrificing the existing low density residential character.

- The existing street grid system, with modifications to enhance views and respond to natural topography, is a good way to provide connectivity between all uses and encourage multimodal transportation.
- New developments and redevelopment projects that place housing within walking distance of shopping, services, employment, parks, recreation, and schools will be the easiest to serve with transit and other alternatives modes of travel.

Chapter 5, Economy

Chapter 5 is the City's economic opportunities analysis. It contains demographic and background information related to employment that will have an impact on the transportation system.

Chapter 5 includes the "recent development" of the Millican Highway connection from Highway 20 (Burns) to OR 126 at the industrial park in the City's locational advantages. It states that the addition of truck stop services near the intersection of the Millican Highway and OR 126 will help to serve the industry while reducing the negative impact of the truck traffic upon the rest of the community at the city center. The Les Schwab distribution plant is also located off of Millican.

Although written prior to any hint that data centers could eventually locate in Prineville, Chapter 5 includes a paragraph highlighting companies "that rely upon the development of technology and the transfer of knowledge products" as businesses that could be targeted by the community which do not rely on proximity to major transportation routes. This paragraph recommends "linking economic development strategies to a technology based economy" as a method to adjust to Prineville's transportation limitations.

Chapter 5 also identifies the "strip" configuration of some of Prineville's commercial corridors as a disadvantage due to poor access control, conflicts with ODOT, undesirable access for commercial developments, and longer vehicle trips to reach needed shopping services. It states that "strip commercial areas on the edges of the community force shoppers to travel by cars along the primary access ways." It identifies mixed use zoning and commercial centers as a means of providing "a better balance of commercial development and reduce unnecessary vehicle trips."

Existing conditions information includes the statement that car commuting in Crook County is higher than other places in Central Oregon due to the rural setting and distances from employment and shopping opportunities in Bend and Redmond. The Plan clearly states a desire to provide jobs in the community and reduce daily commuting to other cities. The section indicates that increased jobs will result in increased population which will, in turn, lead to more local shopping options. In addition, the lack of "desirable" industrial land in Bend and Redmond and the City of Prineville's 2004 UGB expansion, which added over 540 acres of industrial land, may influence commuting patterns and reduce traffic on US 26 and OR 126.

Chapter 5 identifies remanufactured wood, secondary wood products, the Les Schwab distribution plant and ground transportation companies as the primary reasons for the fact that “Prineville has the highest per capita of manufacturing jobs in the state.” Each of these businesses/industries relies on a safe and efficient transportation system to succeed. Therefore, freight movement must be a primary component of the TSP update.

This chapter also highlights the Ochoco Lumber Mill Property. This 75-acre former industrial site is identified in the Comprehensive Plan as a future mixed-use redevelopment site which will likely include “commercial, industrial, open space and housing activities.” This is a key site for the City as it is the only large property in the UGB with potential for large scale commercial and/or mixed-use development. It is important that the TSP take this into account so the community can properly plan for the type of traffic patterns associated with a mixed use project.

Chapter 5 identifies the Prineville Airport as a major industrial area and a top local priority for infrastructure planning and economic expansion incentives. This area includes the Tom McCall Industrial Park, over 100 acres owned by the County and private developers, the Prineville Industrial Park (Tom McCall Expansion), 118 acres of privately owned land, and the Prineville Airport Business/Industrial Park, which has sites available for industrial and commercial development (lease only). The economic analysis concludes that there is a need for additional industrial lands that are situated near the airport, which will require a future UGB expansion. The Plan includes the policy that “adequate public facilities must be planned, funded, and installed to serve industrial sites and commercial areas.”

The following policy excerpts in Chapter 5 are relevant to the TSP update:

- Adequate public facilities must be planned, funded, and installed to serve industrial sites and new manufacturing businesses.
- SDC charges must be carefully monitored and evaluated to ensure that development pays its own way while not creating obstacles to desired development.
- The State of Oregon transportation system (ODOT) has a significant effect upon the local community. Local groups and the City decision makers will need to establish good working relationships with ODOT to ensure coordination and quality development.

Chapter 6, Transportation & Circulation

Chapter 6 identifies the primary east-west and north-south grid streets (arterials and collectors) and discusses transportation choices, railroad issues, transit facilities, bicycle and pedestrian, street capacity and transportation funding. It refers to the City’s TSP as “the long-term master plan addressing transportation needs throughout the community” and “a guide for helping the City make rational choices about the locations and type of needed transportation facilities.”

Chapter 6 briefly identifies the benefits of the Prineville Railroad and lists potential and existing problems related to safety, performance and/or capacity. It identifies the value of the railroad to the Prineville Community as a competitive shipping option for local industry “to almost anywhere in the United States.”

Chapter 6 also describes operations and planned improvements at the Prineville Airport. Per this chapter, there are approximately 500 take-offs and landings per month with over 20,000 people per year using the airport. There are two runways and an improved taxiway, which is sufficient to handle corporate jets and general use aviation aircraft. Most of Crook County's large business, commercial and heavy industrial firms use the airport. The Plan states that airport development and expansion is important for Crook County's overall economic growth and that the airport is in the process of expanding, consistent with the adopted Airport Expansion Plan.

The transit section of Chapter 6 was adopted prior to Cascades East Transit commencing operations in Crook County and only refers to shuttle services offered by private businesses or community-based organizations.

In regard to bicycle and pedestrian facilities, Chapter 6 identifies "the lack of developed marked routes and continuous grid pattern" as an obstacle to "full utilization of safe and efficient bicycle and pedestrian routes." It identifies the Ochoco Creek Bike Path system as an amenity serving "several activity centers, among which are the public parks, schools and central Prineville," however, it also notes that there are many areas of town not served by the trail or any complete sidewalk network, including the fairgrounds, high school and several commercial and industrial areas.

Chapter 6 contains the following goals, all of which are relevant to the TSP update:

- Goal #1: Create a functional transportation system to maximize and extend the life of transportation facilities and improve livability throughout the Prineville Community.
- Goal #2: Create a supportable method for determining and monitoring street capacity and service levels needed for a safe and efficient transportation system.
- Goal #3: Create a supportable method for determining adequate and consistent transportation impact analyses, mitigation procedures, and transportation improvement options.
- Goal #4: Develop a supportable and sustainable financing method for funding necessary transportation system master plan improvements over the life of the Plan.

Chapter 7, Housing

This chapter discusses the importance of providing sufficient land within the urban growth boundary to support a range of housing types for all socioeconomic levels of citizens. It discusses the "unprecedented residential development" that occurred in the early to mid-2000s and states that this growth has "put a strain on public services." The following policy excerpts in Chapter 7 are relevant to the TSP update.

- The community should maintain the feel of a small community through careful design of new and redeveloping residential areas.

- The Prineville community desires to preserve, protect, and strengthen the vitality and stability of existing neighborhoods while permitting uses that make neighborhoods more “complete” and reduce vehicle miles traveled.
- Multi-modal access should be provided internally and to adjacent new and existing neighborhood developments.
- Higher density developments should be in close proximity to schools, services, parks, shopping, employment centers, and public transit.
- The location of most multi-family housing will be best suited near the City core, major transportation corridors, schools, services, parks, shopping, employment centers, and transit corridors.
- A lack of particular housing choices create traffic congestion as people commute from one community to another, increase costs for businesses related to employee travel time, employee absences, unnecessary street expansions and parking demand, reduced mobility for certain disadvantaged groups, and unnecessary community subsidy to remedy these and other impacts.

Chapter 8, Public Services and Facilities

This chapter identifies and describes current public facilities and services provided to residents of Prineville, whether by the City, County or utility company. The following policy excerpts in Chapter 8 are relevant to the TSP update:

- Local plans for providing urban levels of services to all land with the UGB must be comprehensive.
- Providing needed services in an economic and effective manner is good business and a good growth management tool.
- Plans providing for public facilities and services should be coordinated with plans for designation of urban boundaries, zoning, urbanizable land, rural uses and for the transition of rural land to urban uses.
- Public facilities and services in urban areas should be provided at levels necessary and suitable for urban uses without reducing service levels of existing residents.
- Public facilities and services in urbanizable areas should be provided at levels necessary and suitable for existing uses. The provision for future public facilities and services in these areas should be based upon: (1) the time required to provide the service; (2) reliability of service; (3) financial cost; (4) levels of service needed and desired; and (5) economic benefit to the community.
- A public facility or service should not be provided to outlying urbanizable areas unless there is provision for the coordinated development of all the other urban facilities and services appropriate to that area.

- The Prineville community understands that making growth pay its own way is one of the many techniques that can sustain limited resources without resulting in unnecessary subsidy.
- The Prineville community expects the local school district and City Planning officials will coordinate the location of new school site and implement strategies for multiple use spaces. The opportunity for reduced vehicle usage at school campuses should be evaluated and implemented.

Staff Updates to 2005 TSP (not formally adopted)

In 2009, City staff began preliminary work on an update of the TSP. There were several reasons for this in spite of the fact that the TSP had been updated just four years earlier, including:

- Many of the projects identified in the 2005 TSP have been completed.
- Other projects have either been altered or eliminated as priorities.
- Since 2005 significant growth occurred that highlighted deficiencies in the transportation system and it became obvious that there are many critical projects not identified in the 2005 TSP.
- Cost estimates for projects in the 2005 TSP were not updated from the original 1998 TSP.

The work of staff was summarized in the following four technical memorandums, as described below.

Technical Memorandum #1: Development of Project Priority Matrix

This memo describes the method used by staff to identify and prioritize projects. Per this memo, the projects in the 2005 TSP were evaluated to determine if they should continue to be considered as priorities. All collector and arterial streets within the Prineville UGB were evaluated to determine improvements needed to ensure city standards and projected capacity needs could be met through the buildout of the city's UGB. Finally, projects were ranked utilizing a project priority matrix. There are two documents that are exhibits to Technical Memorandum #1: a matrix weighting worksheet, used by staff to assign scores to projects based on weighted categories, and the Key for the Project Priority Matrix, which describes in detail each of the scoring categories.

Technical Memorandum #2: Project Cost Estimates

This memo describes the method and assumptions used to develop the Project Cost Summary. It includes a table of unit costs (i.e. cost of sidewalk per square foot, cost of curb per linear foot, cost of right-of-way by zone, engineering as a percent of overall project cost, etc.). It also includes a detailed description of each of the cost categories and a detailed description of how each of the unit cost estimates were derived.

Technical Memorandum #3: Traffic SDC

This memo summarizes the methodology used to calculate the City's current transportation system development charge (SDC). Project cost estimates for all priority projects were included in the SDC calculations and highlighted in the memo. The calculation included consideration of estimated project costs, the Working Project Cost Allocation table, a breakdown of estimated benefit of each project to existing vs. future transportation system users, and the estimated number of p.m. peak hour trips that would be generated by future system users.

Technical Memorandum #4: Tom McCall Intersection Impact Fee

The 2005 TSP included cost estimates for a grade separated interchange at the intersection of OR 126 and Tom McCall Road or Millican Road, as well as a percentage breakdown of project costs to be paid for by State, County, City and private sources. However, it did not include any mechanism to collect these funds from private sources. This left potential developers in a position where they would either generate too few trips to trigger any improvements to the intersection and not have to contribute at all to a future improvements or they would generate a large enough number of trips for ODOT to require the construction of the grade-separated interchange.

In order to address this issue and ensure that all developments pay their share, and no single development has to complete a major improvement, Technical Memorandum #4 was generated to establish an impact fee to be assessed to any development that accesses OR 126 via the Tom McCall or Millican Road intersections. This memo summarizes the methodology, which includes an estimated project cost for a multi-lane roundabout (identified in a report by Group MacKenzie as an alternative to the grade separated interchange), an anticipated breakdown of project responsibility among ODOT, Crook County, the City and private development, and an estimate of the additional trips that could be accommodated by the roundabout. The result was an impact fee of \$1,452 per p.m. peak hour trip.

Other Key City Staff Work

In addition to these technical memorandums, City staff developed numerous spreadsheets to summarize critical information. The most significant of these are the Project Priority Matrix, Project Cost Summary and Working Project Cost Allocation. These tables are summarized below.

Project Priority Matrix

This matrix lists the 24 projects identified by staff as priorities and details the weighted rankings the projects received based on the scoring criteria described in the matrix key. The categories and sub-categories considered include the following:

- Safety
 - Pedestrian & Bike

- Vehicular
- Level of Service
 - Circulation
 - Intersections
- Economic Development
 - Downtown
 - Commercial/Industrial Areas
- Community Development
 - Appearance
 - Accessibility
- Feasibility
 - Financial
 - Political

Each of the categories and sub-categories had a weighted score determined by averaging staff scores on each criterion. The result was a prioritized list which identified seven high priority projects (score of 150+ out of a possible 300), nine medium priority projects (score between 100 and 149.9), and eight low priority projects (score under 100).

Project Cost Summary

This spreadsheet describes the cost of each project based on the following breakdown, which was determined through the process described in Technical Memorandum #2. Cost centers include the following:

- Full street improvements
- Partial street improvements
- Traffic signals and structures
- Professional services
- Mobilization and temporary traffic control
- Project management
- Right-of-way acquisition
- Contingency

The total estimated cost for all 24 projects was \$99.4 million.

Table 1-7 summarizes the priority rankings and cost estimates complete by staff. It is important to note that this in no way reflects any adopted plan or the will of the community. It was merely an activity completed by staff in preparation for the upcoming TSP update process.

Table 1-7 City of Prineville Transportation Priority Rankings

Project Title	Staff Score	Staff Cost Estimate
9 th St. N – Main St. to 7 th St. E	204.3	\$7,429,351
West “Y” Roundabout	187.0	\$3,364,900
Laughlin Rd – 7 th St/Juniper to 3 rd St NW	177.4	\$7,177,993
2 nd St. N – Dead End West to Knowledge/3 rd St	174.2	\$5,489,905
Tom McCall/Millican Intersection	157.8	\$18,820,120
Lynn Blvd – Main St. to Combs Flat	156.5	\$3,747,552
Main St. – Lamonta to N. City Limits	150.2	\$3,855,871
Lamonta – Gardner to Main	147.4	\$5,264,147
Peters Ext. to Combs Flat / Combs Flat to 3 rd	141.2	\$5,345,340
Peters Rd. Extension – Main to Lamonta	132.0	\$3,163,930
Main St. – Lynn Blvd to Lamonta	131.5	\$4,513,094
Brummer Rd. – Main St. to George Millican	127.9	\$8,398,632
Gardner Rd. – Madras Hwy to Lamonta	123.0	\$1,780,336
Brummer Rd. – Davis Loop to Main St.	119.6	\$5,291,088
Peters Rd. – Main St. to Yellowpine	101.4	\$664,046
Combs Flat Rd. – 3 rd St. to Laughlin	100.1	\$558,850
Harwood St. – 3 rd St. NW to Lamonta	98.9	\$687,736
Elm St. / Fairview St. – Lynn to 10 th St.	97.3	\$723,668
Combs Flat Ext. from Peters to Barnes Butte	93.5	\$3,625,930
4 th St. N – Harwood to Elm	88.1	\$2,120,782
Main St. – S. City Limits to Lynn Blvd.	87.8	\$386,331
Deer St. – 5 th Pl. to Lamonta	82.1	\$644,360
9 th St. N – Madras Hwy to Main St.	80.3	\$4,252,796
Yellowpine Rd. – Peters to City Limits	78.5	\$2,103,897

Working Project Cost Allocation

This table assigns a percentage of the cost of each project to each of the potential funding partners – ODOT, Crook County, the City and private development. Based on this analysis, approximately \$34 million is the responsibility of the state, \$14.7 million as the responsibility of the county, \$38.4 million the responsibility of the City, and \$12.3 million the responsibility of private development. The table then further breaks down the City’s portion of each project into a percentage of benefit to existing vs. future transportation users. Based on this analysis, \$9.5 million of the project costs benefit existing users and \$28.9 million of the project costs benefit future users. The latter number is the one used in Technical Memorandum #3 to estimate the transportation SDC if all 24 projects were to be funded.

City of Prineville 2005 Transportation System Plan

The City of Prineville adopted its Transportation System Plan in 2005 in compliance with the requirements of the Transportation Planning Rule. The plan was developed to address several key issues within the City related to its vision and accommodating planned growth:

- Improvement options for the Prineville “Y”
- Review of whether 3rd Street – US 26 should be improved to a higher-capacity form (couplet, five-lane cross-section, or left as-is)
- Realignment considerations for the O’Neil Highway
- Tom McCall/Millican Road intersection with OR 126 improvements
- 9th Street Truck Route and Extension

Generally, the City’s Transportation System Plan identified that major improvements would be needed to improve conditions along 3rd Street. While the plan did not identify the need for cross-section changes through the downtown core, it was reliant on parallel routes (such as 9th Street) off-loading 3rd Street demands. While the 9th Street extension has not been completed, recent efforts by the City to provide parallel capacity on 2nd Street have been completed.

There have also been significant land use changes since the TSP was prepared. Land use assumptions within the adopted plan did not specifically account for Iron Horse, Anglers Canyon, Rivergate, or River Steppes developments that are expected to concentrate growth within specific areas of the City. External growth in areas such as Juniper Canyon and destination resorts may also influence the levels and patterns of growth. Current data center development within the City’s Tom McCall business park also provides a change to the intensity of expected growth from what was envisioned within the prior plans.

Each of the key issues (outlined above) related to the City’s vision and planned growth, is separately addressed within the TSP at the conceptual level. While many of these improvements were identified as necessary within the planning horizon, the financial changes that occurred with the recession reduced funding and forced the City to scale back and phase in improvements. Other elements, such as the Prineville “Y” and access surrounding the airport industrial lands were more recently addressed as part of the OR 126 Corridor Plan.

Additional changes have recently occurred with the adoption of revised mobility targets for State facilities. While these may not change the system needs, they may influence the size and scale of improvement options that are required.

Due to the changes to the transportation system, revised growth projections, changing revenue, and a desire to review mixed use zoning provisions, the TSP update will need to review key issues from this prior plan and determine if modifications will be required. Review of the prior input, concerns, and discussions will be used to help inform the solution options considered within the City’s TSP update.

City of Prineville Downtown Enhancement Plan

The Downtown Enhancement Plan was adopted in June 1997 and has been inconsistently implemented since that time. The plan includes a summary of existing plans affecting the downtown core, a summary of land uses in the study area and an inventory of sidewalks,

bikeways, parking, utilities, building architecture, signage and parks and open space. The recommendations are the most significant part of the plan and include the following:

- Basic design guidelines related to building mass, materials and scale;
- Sidewalk width of 10-12 feet;
- Installation of concrete bulb-outs to reduce pedestrian crossing distances at intersections;
- Limitations on vehicular access and encouraging utilization of alleys;
- Provision of on-street parking as well as restrictions on city-owned, off-street parking areas;
- Guidelines for landscaping and street tree selection;
- Guidelines for street furniture, bicycle parking and lighting; and,
- Regulations for sidewalk construction in the downtown core (cobblestone or imprinting).

Prineville/Crook County Airport Master Plan

The Airport Layout Plan Report (Report) was developed jointly by the City of Prineville and Crook County, with the support of the Oregon Department of Aviation (ODA), so that the Prineville Airport could continue to qualify for federal Airport Improvement Program (AIP) grants for eligible facility improvement projects. The Report recognizes the role that this general aviation airport in providing access to the statewide transportation system, as well as both direct (i.e., employment) and indirect economic activity within the local community and region. The Report also points to the airport's role in the joint effort by the City and County to attract new, large employers to the area, noting that the County owns most of the available undeveloped industrial land adjacent to the airport and that expanding a diversified industrial base within the county is a primary component of the region's economic development strategy. Key report conclusions related to land use and traffic in the vicinity of the airport include:

11. The existing zoning associated with Prineville Airport does not fully comply with ORS Ch. 836.600 et. Seq.

12. The east side of the airport currently accommodates all landside facilities. It is anticipated that this area will not have sufficient landside capacity to accommodate projected facility demands without redevelopment and/or reconfiguration of existing facilities. If existing facility configurations are maintained, expansion to the north side of Runway 10/28 will be required during the current planning period.

13. The planned expansion of landside facilities into undeveloped areas of the airport will require the extension of utility service (water, electrical, telephone, sanitary sewer, etc.) and airport access roads. Utility improvements are not eligible for FAA funding, therefore will require local funding. Access roads that serve aviation developments are generally eligible for FAA funding.

The Report's recommendations include upgrading and widening runways, adding taxiways, adding floodlighting to the existing terminal area and other existing landside areas (hangars, aircraft parking, etc.), and fencing along the airport's boundary. Transportation recommendations relevant to OR 126 facility planning include:

7. Any future improvements to Highway 126 in the vicinity of the airport should be designed to avoid creating obstructions to the approach surfaces of Runway 28 and 33, as depicted on the updated airspace drawings contained in this report.

20. Any planned improvements to Highway 126 in the vicinity of the airport should be designed to avoid any obstruction to the Prineville Airport's FAR Part 77 imaginary surfaces. In addition, any lighting associated with the highway in the vicinity of the airport should be designed to avoid producing excessive upward light emissions that could create a hazard for aircraft operating at the airport.

Chapter 2 notes that all landside developments (hangars, aircraft parking, services, etc.) are located at the east end of the airport and are served by an access road that connects to OR 126. Citing information provided by the local chamber of commerce, Chapter 2 reports that the airport has three industrial parks nearby with more than 100 acres of land zoned for heavy industry. The background information on the airport lists the patrons as a "variety of general aviation users, including business, commercial, and government aviation," as well as the United States Forest Service (USFS) and the Bureau of Land Management (BLM).

Under "Land Use Planning and Zoning," the Report states that the airport is located entirely within the City's UGB and city limits. Land is zoned Airport Operations (A-O); Airport Development (A-D); Airport Business – Industrial (A-M); and Airport Commercial (A-C). City and/or County industrial zoning is located to the southeast, east, and north of the site, with the remaining areas in Crook County Exclusive Farm Use (EFU3) Zoning.

The remainder of Chapter 2 deals with the methodology of updating the forecasts of aviation activity and translating future activity into gross facility needs for the 20-year planning period. Air traffic at the airport is predominately general aviation with a small amount of government activity, where business jet activity currently accounts for more than 12% of annual operations and is expected to increase in the future. More than 430 aircraft are located within Prineville's airport service area; Prineville currently accounts for about 17 percent of the area's aircraft, with Bend and Redmond accounting for more than 60 percent. The Report concludes that competition among airports (services and facilities) will continue being a primary factor affecting aviation activity at all airports within the local service area. The Report looked at national general aviation trends, as well as local population to predict future airport usage, and concludes that aviation activity at the airport has generally outpaced population growth in recent years. Long-term forecasts of Crook County population reflect a moderate increase (1.6 percent annual average growth) over the next twenty to forty years and airport activity is expected to increase at a slightly higher rate than County population. An annual average growth rate of 3.1 percent was used to project area-based aircraft through the twenty-year planning period to provide a more aggressive projection. Aircraft operations are projected to increase at an average annual rate of

4.5 percent. The higher rate of growth in operations is based on the assumption that the average aircraft utilization at the airport will gradually increase from its current 120 operations per based aircraft to 160, which is equal to the airport's long-term historic average.

Chapter 4 describes a preferred alternative for the airport layout, a refinement of an earlier concept ("Concept A") that involves the redevelopment of the existing east-side facilities located between the ends of Runways 28 and 33, OR 126 and the main access taxiway. The aim of Concept A was to eliminate the "patchwork pattern of development" by maximizing the efficiency of existing developed areas (east landside area) to address facility needs before proceeding with the development of other parts of the airport. The preferred alternative supports redevelopment of east side facilities where feasible and designates large development areas and development reserves on the north side of Runway 10/28 for general aviation, agricultural, military and government aviation use. A previously-planned realignment of the main airport access road allows for the development of aviation-related facilities east of the existing access road, which currently cannot be accessed by aircraft without taxiing across the roadway. This new north airport access road would extend from an existing service point on OR 126 and is described in the Airport Layout Plan as follows:

The existing airport access road will be realigned to accommodate a combination of aviation and aviation-related developments between OR 126 and existing east landside development. The existing access road will be gated at the north and south ends of the development area to provide limited vehicle access. The area will be developed to accommodate aircraft hangars on both sides of the existing access road and hangar taxiways will be extended to serve hangars located on the east side of the existing road.

In addition, the Airport Layout Plan calls for the following:

A location for an emergency services building is identified near the southeast corner of the airport. This facility is envisioned to provide emergency response services on the airport and to adjacent areas through direct access to OR 126.

City of Prineville Land Use Code (Chapter 153)

The City of Prineville's Land Use Code implements the goals, policies, and objectives expressed in the City's Comprehensive Plan. Sections 153.045 through 153.064 (Use Zones) specify the allowed uses and associated regulations for each zoning district in the City. There are 15 zoning districts currently represented in the city, including three residential zones, four commercial zones, three industrial zones, four airport zones and a park reserve. In addition, there are three zones that are available within the code but have not yet been applied to any specific properties; these are the high density residential zone, low density residential zone and neighborhood commercial zone. Future application of these zones could have a significant impact on the transportation system.

Transportation facilities are identified specifically in each zone as permitted and/or conditional uses and bike paths and walking trails are permitted outright in all zones. All the City zoning

districts allow maintenance and repair of existing roadways, as well as the construction of new facilities, if identified in an adopted transportation plan. In addition, a wide range of highway improvement activities are permitted outright in all zones and are exempt from local permit requirements, including the installation of additional lanes and pedestrian and/or bikeways within a highway right-of-way.

Section 153.195 provides guidelines for access management. The standards are presented as “guidelines” that the reviewing authority “shall consider” in the review and approval of new development. Major arterials require 500 feet between driveways and/or streets and ¼ mile between intersections while minor arterials require 300 feet between driveways and/or streets and 600 feet between intersections. Collectors require 50 feet between driveways and/or streets and 300 feet between intersections. This section also identifies other techniques and considerations for restricting access to arterials and collectors, but does not include any requirements for their use. These standards will be evaluated during the TSP update.

Additional requirements for access management are provided in some of the zones. The airport zones, commercial zones and industrial zones include a requirement that new development be designed so that traffic does not onto a public street right-of-way while entering or exiting a particular development. In the Park Reserve zone, there is a general requirement that access points from public streets must be located to “minimize traffic congestion, noise and dust pollution and to protect scenic views and vistas.” In the industrial zones, there is a similar standard for access to “minimize traffic congestion, noise and dust pollution,” and “...avoid directing traffic onto residential streets or onto streets passing directly through residential, school, hospital or other noise sensitive use areas and safety zones.” The zoning ordinance gives the city the ability to require access to lower order streets (when there are multiple options for access) for any residential, commercial or industrial development in any zone.

Notably absent from the Land Use Code are development requirements related to traffic impact analysis (TIA); TIA requirements are found in Appendix A to the 2005 TSP. These were subsequently amended by the City.

City of Prineville Standards and Specifications

The City of Prineville adopted its first Standards and Specifications in 2007 and they are reviewed and updated annually with the most recent update in 2011. Chapter 6 covers “Streets and Related Work.” This chapter includes guidelines and regulations for all work that is completed within the public right-of-way or easements utilized by the city for public access. It includes tables and text specifying minimum standards for construction of any public road as well as procedures that must be followed in relation to all aspects of road construction, such as temporary traffic control, inspection, sampling and testing, base preparation, etc.

One of the most significant aspects of the Standards and Specifications to transportation planning are the typical street cross sections provided within this chapter. These cross sections, along with the associated tables, lay out dimensional standards for each street type, including right-of-way, pavement, vehicle travel lanes, bicycle lanes, sidewalk, and curbs. The cross

sections and tables also include standards for asphalt and concrete depth, aggregate base depth, curb return radius, design speed and maximum grade. Arterial streets require 100 feet of right-of-way while collectors require 80 feet and local streets require 60 feet. Paved width (curb to curb) depends on both the type of street and surrounding uses. Arterials require a minimum of 50 feet paved width while the width of pavement on collectors ranges from 36 feet to 44 feet depending on whether there is on-street parking and whether it is used primarily by industrial traffic or residential/commercial traffic. Local streets require 35 feet of paved width. The cross section tables also include basic standards for all weather service roads, all weather utility accesses and alleys. Modifications to the cross-section requirements will be addressed as part of the TSP update.

City of Prineville Buildable Lands Inventory (2004)

The Buildable Lands Inventory was developed to support Prineville's 2004 urban growth boundary (UGB) expansion. The Buildable Lands Inventory accounted for vacant, buildable, and redevelopable parcels by zoning district to determine a net amount of available land within the existing UGB at the time. It evaluated the mix of housing and residential densities within the UGB as well as employment forecasts and employee/acre ratios in commercial and industrial lands. Ultimately, the Buildable Lands Inventory resulted in a projection of residential, commercial and industrial land needed between 2004 and 2024.

The Buildable Lands Inventory recommended the addition of 1,429 total acres to the UGB including 870 acres of residential land, 40 acres of commercial land, 371 acres of industrial land and 148 acres of open space/park reserve land. The employee/acre ratios utilized to arrive at this recommendation were 10.1 employees/acre for industrial development, 46.6 employees/acre for office development and 21.5 employees/acre for retail development. The average residential density, based on four different scenarios of potential growth patterns, ranged from 6.5 to 7.4 units/acre.

City of Prineville Current and Past Transportation Budget

There are two primary funds within the adopted 2012-2013 City of Prineville Budget. These are the Transportation SDC Fund and the Transportation Fund. The Transportation SDC Fund accounts for the receipt and expenditures of Transportation System Development Charges (SDC) improvement fees. The Transportation Fund provides the accounting of the City's street, bike lane, right-of-way and storm water maintenance.

The Table 1-8 summarizes resources and expenditures for the past three fiscal years as well as projections for the current year.

Table 1-8 Transportation Revenue

	FY 09-10	FY 10-11	FY 11-12	FY 12-13
Transportation SDC Fund Resources	\$67,621	\$199,206	\$90,400	\$150,800
Transportation SDC Fund Expenditures	\$167,256	\$532,302	\$114,200	\$167,500
Transportation Fund Resources	\$888,715	\$922,794	\$903,661	\$939,000
Transportation Fund Expenditures	\$972,131	\$888,917	\$1,155,300	\$1,161,900

City of Prineville Current and Historic Funding Sources

New street improvements, related to the capacity improvements for new development, has been funded primarily by system development charges. The previous table shows the actual and estimated revenue in the Transportation SDC Fund. The Transportation Operations Fund has a wider variety of funding sources. In recent history, the primary sources of revenue for this fund has been the State of Oregon gas tax and, to a lesser extent, state revenue sharing and the STP fund exchange program. Recognizing the impact that the installation of public utilities have on the need for street repairs, the City of Prineville recently established two new revenue sources for the transportation fund – the City’s water and wastewater funds now pay franchise fees to the transportation fund. The following table shows the funding sources for the Transportation Fund over the past three fiscal years as well as projections for the current year:

Table 1-9 Transportation Fund Revenues by Source

	FY 09-10	FY 10-11	FY 11-12	FY 12-13
Water Franchise Fee	\$0	\$0	\$0	\$80,300
Wastewater Franchise Fee	\$0	\$0	\$0	\$142,000
Licenses & Permits	\$15,723			\$6,000
Charges for Services	\$0	\$20,006	\$0	
Taxes including: STP Fund Exchange Prog State Revenue Sharing Oregon Gas Tax	\$868,255	\$893,856	\$876,803	\$704,700
Miscellaneous Income	\$4,737	\$8,892	\$26,858	\$6,000

Section 2

Technical Memorandum 2: Goals and Objectives



CITY OF PRINEVILLE TRANSPORTATION SYSTEM PLAN



MEMORANDUM

Date: June 12, 2012 Project #: 12221.0
To: Scott Edelman, City of Prineville
Devin Hearing, ODOT
Project Advisory Committee
Project: City of Prineville Transportation System Plan
Subject: Draft Technical Memorandum #2: Goals, Objectives and Evaluation Criteria

This memorandum presents goals, objectives and a draft set of evaluation criteria for the City of Prineville Transportation System Plan (TSP) update. The goals and objectives will help guide the TSP update process to ensure key issues are addressed within this process. The evaluation criteria will be used to set policies and identify “preferred alternatives”, which will comprise the list of recommended projects and associated policy, code amendments, and funding actions in the TSP.

This document is organized as follows:

- **Background:** This section describes the changes in Prineville following adoption of the 2005 TSP.
- **Goals:** The goals are the desired project outcomes and needs that support the land use and growth vision for Prineville. The project goals were developed based on guidance from agency staff, review of the prior TSP, findings of the OR 126 Corridor Plan, the Transportation Growth Management (TGM) grant application submitted by the City of Prineville, and on conversations with City, County, and ODOT staff.
 - **Objectives:** The objectives expand on the project goals and outline the discrete elements that, taken as a whole, summarize the goal.
 - **Evaluation Criteria:** The evaluation criteria were developed to measure and respond to the objectives and ultimately to the project goals.
- **Action Items:** Specific items to be addressed within the TSP.

The purpose of this draft document is to outline the consultant understanding of these elements. This will be further discussed at the June 13, 2012 meeting, with meeting comments and subsequent comments received incorporated into a final draft that will be resent to the Project Advisory Committee and approved as part of our July meeting.

Background

The existing City of Prineville Transportation System Plan was adopted in 2005. Since that time, there have been significant changes in Prineville, as outlined below.

- The City of Prineville has approved several significant developments that have the potential to shape growth and transportation system needs in Prineville over the next 20 years. These planned developments are to be located in the southwest and northeast areas and were not contemplated as part of the growth assumptions in the prior TSP.
- The recently completed OR 126 Corridor Plan identifies system needs where OR 126 transitions down the grade and into downtown Prineville. This transition includes a change in State and City priorities for access and mobility and will have implications in the downtown area.
- Recent investments in the City's rail infrastructure have created new opportunities within the City for attracting specialized industries that rely on rail service. Within the TSP the City should consider how to leverage these prior investments and preserve, extend, and enhance its rail network and interactions with its streets.
- The City has seen a large interest in locating additional data centers in the Tom McCall area. Formalization of a transportation plan in that area will help foster and support this investment.
- The City wants to consider measures, such as development of mixed-use zoning, that will encourage travel modes other than single-occupant vehicle trips.
- The City of Prineville implemented a transportation system development charge (SDC), though no similar fee is required in Crook County.

Several general goals were established by the consultant team to help guide the development of the City of Prineville TSP update. These general goals are:

1. Ensure a safe and efficient transportation system for all users.
2. Improve access to the transportation system for all users, including low income and minority populations.
3. Integrate a multi-modal system including bicycle and pedestrian pathways, sidewalks, and bicycle lanes throughout the community, particularly to connect residential areas with schools, parks, and activity centers.
4. Improve the local circulation system to reduce the community's reliance on State Highways to travel to local destinations.
5. Build and maintain the transportation system to facilitate economic development in the region.

6. Improve system performance by balancing mobility, access, community growth, and Prineville's identity, particularly along main travel routes.
7. Minimize the impacts of transportation system development on the natural and built environment.

To more specifically address the changes and needs that have occurred or been identified since the 2005 plan, five specific action items are suggested.

1. Incorporate specific land use plans and zoning within Prineville to more accurately project and plan for long-term transportation system needs.
2. Review and revise or incorporate findings of the OR 126 Corridor Plan within City limits (Tom McCall to the "Y", and into downtown).
3. Integrate mixed-use zoning into the City's transportation plans.
4. Integrate the City's roadway and rail transportation planning.
5. Update the City's Transportation System Development Charge (SDC) based on the revised needs.

An underlying objective of the TSP update process is to satisfy the requirements of the Transportation Planning Rule (TPR, Oregon Administrative Rule 660-012) for a TSP update. This includes compliance with Title VI (civil rights) requirements and collaborating with plan area residents and transportation users through the City and County Planning Commissions, City Council, County Court, public open houses, key participant workshops, and the public website. It also includes ensuring compliance with the TSP content requirements of the TPR and consistency with the Oregon Transportation Plan (OTP), Oregon Highway Plan (OHP), adopted local, regional and state plans, and ODOT's TSP guidelines.

Goals and Objectives

Based on the goals for the TSP update, we developed draft objectives and evaluation criteria to assess the progress towards each goal. The goals and the corresponding objectives and evaluation criteria are below.

Goal #1: Ensure a safe and efficient transportation system for all users

Objectives

- 1A. Coordinate with existing safe routes to school (SRTS) plans and identify potential engineering components for future SRTS plans for local schools.

- 1B. Strategically plan for safety and operational improvements for bicyclists and pedestrians.
- 1C. Incorporate the Highway Safety Manual (HSM) into development review and capital project evaluation processes.
- 1D. Consider strategies to reduce crashes throughout the study area, particularly higher severity injury and fatal crashes, and those involving more vulnerable roadway users such as pedestrians and bicyclists.
- 1E. Meet applicable City, County, and/or State operational performance measures or identify alternative measures as appropriate in balancing other City goals and needs.

Goal #2: Provide access to the transportation system for all users, including low income and minority populations

Objectives

- 2A. Provide transportation mode choices to all users of the transportation system.
- 2B. Consider impacts to low income or minority populations when assessing the impacts of transportation infrastructure projects.

Goal #3: Integrate bicycle and pedestrian pathways, sidewalks, and bicycle lanes through the community, particularly to connect residential areas with schools and activity centers

Objectives

- 3A. Incorporate safe and convenient connections between travel modes.
- 3B. Identify ways to improve street connectivity (or route connectivity) to provide additional travel routes for bicyclists, pedestrians, and autos.
- 3C. Prioritize projects that improve pedestrian and bicycle system connectivity in areas near schools or other areas of high activity.
- 3D. Provide signing and pavement markings to identify bicycle and pedestrian networks through the City and to help bicycle and pedestrians reach their destinations via the network.

Goal #4: Improve the local circulation system to reduce the community's reliance on State Highways to travel to local destinations

Objectives

- 4A. Provide alternative routes to the state highways and improve the attractiveness, user awareness, and capacity of parallel routes.

- 4B. Develop local circulation plans identifying valuable new local circulation routes and connections.

Goal #5: Build and maintain the transportation system to facilitate economic development in the region

Objectives

- 5A. Improve the movement of goods and delivery of services throughout the region using a variety of travel modes.
- 5B. Ensure adequate capacity for future travel demand and multiple modes on collector and arterial streets and on the local highways to enable economic development in the community.
- 5C. Identify lower cost alternatives or provide funding mechanisms for transportation improvements necessary for development to occur.
- 5D. Program transportation improvements to facilitate the development of desired land uses.
- 5E. Provide adequate capacity at rail crossings to meet demand.

Goal #6: Improve system performance by balancing mobility and access, particularly along main travel routes

Objectives

- 6A. Develop an access management plan or policies that reflect desired character and operations of roadways and is feasible in terms of adoption and enforcement.
- 6B. Incorporate the Highway Safety Manual (predictive safety) analysis into corridor planning, operations and design activities to help guide safety investments.
- 6C. Incorporate multimodal level-of-service (MMLOS) analysis from the Highway Capacity Manual (HCM) 2010 to inform cross-sectional design trade-offs.

Goal #7: Minimize the impacts of transportation system development on the natural and built environment.

Objectives

- 7A. Reduce vehicle miles traveled (VMT) to reduce emissions.
- 7B. Improve travel options throughout the City and connecting Prineville to Central Oregon.

- 7C. Provide flexibility within City design standards to reduce water run-off and street maintenance costs.
- 7D. Use technology to improve efficiency and safety of the transportation system.
- 7E. Promote transportation demand management strategies (carpooling, flexible work hours, telecommuting, etc.) to reduce VMT on the transportation system.

Action Items

Action items provide a summary of some of the key elements of this TSP update process.

Action Item #1: Incorporate specific land use plans and zoning within Prineville to more accurately project and plan for long-term transportation system needs.

Objectives:

- 1A. Improve the integration of the City's land use projections and transportation system planning efforts.
- 1B. Consider the regional inputs to the City's growth, such as Juniper Canyon, destination resorts, and other inputs that are external to Prineville.
- 1C. Consider land use changes that can retain workers within Prineville.

Action Item #2: Review and revise/incorporate findings of the OR 126 Corridor Plan within City limits (Tom McCall to the "Y", and into downtown).

Objectives:

- 2A. Develop a consistent planning vision for OR 126, including a refined vision for the transition to the downtown and roadway junctions throughout Prineville City limits.
- 2B. Understand the travel demands for travel to urban areas west of Prineville and identify what types of land use, infrastructure, management, or policy elements could be applied to accommodate this travel.
- 2C. Provide a public process to develop and refine alternatives and allow an informed decision-making process.

Action Item #3: Integrate mixed-use zoning into the City's transportation plans.**Objectives:**

- 3A. Provide a legislative zone change and plan amendment process to support adoption of mixed-use zoning within the City of Prineville within the TSP process.
- 3B. Identify transportation infrastructure and connection needs to support development of mixed-use centers and provide additional certainty to future development applications.

Action Item #4: Improve the integration of the City's roadway and rail transportation planning.**Objectives:**

- 4A. Separately understand the characteristics of the rail and roadway system serving Prineville and how they interact.
- 4B. Provide the City's rail system the ability to expand to respond to opportunities through the planning horizon.

Action Item #5: Develop a realistic and achievable funding plan that can be implemented incrementally over time.**Objectives:**

- 5A. Recognizing that transportation infrastructure project costs will exceed projected revenue, rank and prioritize improvements and develop projects that will incrementally build toward ultimate solutions.
- 5B. Develop a flexible system that can adjust and shift priorities based on the locations and types of growth that occur.

Evaluation Process

A qualitative process using the criteria above will be used to evaluate the policies and alternatives developed through the TSP update. The rating method used to evaluate the alternatives is described below.

- Most Desirable: The concept addresses the criterion and/or makes substantial improvements in the criteria category. (●)
- Moderately Desirable: The concept partially addresses the criterion and/or makes some improvements in the criteria category. (◐)

- No Effect: The criterion does not apply to the concept or the concept has no influence on the criteria. (Ø)
- Least Desirable: The concept does not support the intent of and/or negatively impacts the criteria category. (●)

At this level of screening, the criteria will not be weighted; the ratings will be used to inform discussions about the benefits and tradeoffs of each alternative.

EVALUATION CRITERIA

Table 1 presents the evaluation matrix that will be used to qualitatively evaluate the policies and alternatives developed through the TSP update.

**Table 1
Evaluation Matrix**

Criteria Reference Number	Evaluation Criteria	Evaluation Measures
Goal 1: Ensure a safe and efficient transportation system for all users		
1C1	Project includes pedestrian and bicycle improvements located within existing or potential SRTS plan areas.	Does the proposed project include pedestrian and bicycle improvements located within a SRTS plan area? Measured as providing no, moderate or significant enhancements for student travel.
1C2	Influence of proposed project on developing new SRTS plans and/or enhancing existing SRTS plans.	To what extent does the alternative facilitate new SRTS plans being developed? Measured by the potential for students to walk or ride a bike to school due to the proposed project.
1C3	Number of conflict points between all modes of travel including crossing points for pedestrians and bicyclists along major arterials.	To what extent does the alternative increase safety by reducing vehicle to vehicle, vehicle to pedestrian/bicycle, or pedestrian/bicycle to pedestrian/bicycle conflict points? Measured as relative impact between alternatives in regards to the number of conflict between modes and speed differential.
1C4	Miles of designated facilities (on-street and off-street) for bicyclists and pedestrians provided.	To what extent does the alternative increase the number of miles of pedestrian and bicycle facilities? Measured by potential expansions of the pedestrian and bicycle systems.
1C5	Intersection visibility and sight distances available to motorists, pedestrians, and bicyclists at intersections and key decision points.	To what extent does the alternative improve sight distance for all system users, allowing each adequate time to identify and react to conflicts? Measured as relative impact between alternatives for providing adequate sight distance based on desired operating speeds.
1C6	Estimated number of fatal or serious injury crashes.	To what extent does the alternative reduce the estimated frequency of fatal and serious injury crashes? Whenever possible, measured using procedures in the HSM for estimating and predicting crash frequency.
1C7	Estimated number of bicycle and pedestrian related crashes.	To what extent does the alternative reduce the estimated frequency of pedestrian and bicycle related crashes? Whenever possible, measured using procedures in the HSM for estimating and predicting crash frequency.
1C8	Percent of facilities meeting applicable operational performance measure.	To what extent are operational performance measures met for the alternative? Measured by the percent of facilities where operational performance measures are met.
Goal 2: Provide access to the transportation system for all users, including low income and minority populations		
2C1	Impact of transportation project on low income and minority populations.	To what extent does the alternative affect low income and minority populations? Measured as relative ability of each alternative to spread the impacts of the transportation system evenly between all users.
2C2	ADA Compliance.	To what extent does the alternative provide opportunities to upgrade pedestrian facilities to ADA standards? Measured by percent of pedestrian facilities meeting ADA standards.

2C3	Viability of non-auto travel.	To what degree are transportation facilities (transit service, sidewalks, bicycle lanes, separated mixed-use paths, parks) for non-auto travelers integrated into the alternative? Measured relative to facilities and integration present in Baseline.
2C4	Incorporation of safe, convenient, and comfortable multimodal facilities.	To what degree does the alternative further multimodal transportation? Measured by degree to which alternatives provides for robust facilities and network connectivity.
Goal 3: Ensure integration of adequate bicycle and pedestrian pathways, sidewalks, and bicycle lanes through the community, particularly to connect residential areas with schools and activity centers.		
3C1	Potential impact on bicycle and pedestrian volumes.	To what degree does the alternative increase pedestrian and bicyclist travel? Measured by potential increase in pedestrian and bicyclist volume relative to Baseline.
3C2	Impact on connectivity of bicycle and pedestrian systems.	To what extent does the alternative improve the connectivity of the existing and proposed pedestrian and bicycle systems? Measured by the extent to which each alternative increases connectivity of pedestrian and bicycle facilities.
3C3	Average trip length for bicyclists from residential areas to activity centers via the bicycle/pedestrian networks.	To what degree does the alternative provide opportunities for bicycle trips from residential areas to activity centers? Measured by the potential increase in average bicycle trip length relative to Baseline.
3C4	Average trip length for pedestrians from residential areas to activity centers via the bicycle/pedestrian networks.	To what degree does the alternative provide opportunities for pedestrian trips from residential areas to activity centers? Measured by the potential increase in average pedestrian trip length relative to Baseline.
3C5	Incorporation of wayfinding signs and pavement markings for pedestrian and bicyclists.	To what extent does the alternative provide for the increase in wayfinding signs for pedestrians and bicyclists? Measured by the increase in wayfinding signs relative to Baseline.
3C6	Number of uncontrolled crossing conflict points between vehicles and pedestrians/bicyclists on the bicyclist/pedestrian network.	To what extent does the alternative reduce the number of uncontrolled crossing conflict points between vehicles, pedestrians, and bicycles? Measured by the number of uncontrolled crossing conflict points relative to Baseline.
Goal 4: Improve the local circulation system to reduce the community's reliance on State Highways to travel to local destinations.		
4C1	Average trip length.	To what degree are land use types dense and well mixed such that average trip lengths for plan area residents are reduced? Measured relative to Baseline average trip length.
4C2	Percent of capacity on regional facilities used for reaching local destinations.	To what extent does each alternative provide viable travel route options for local travelers that are not on regional facilities? Measured by percent of capacity on regional facilities used for reaching local destinations.
4C3	Volume-to-capacity (V/C) ratios on parallel routes to highways.	To what extent do viable local road alternatives to state highways provide sufficient mobility? Measured by relative number of facilities providing sufficient mobility compared to Baseline.

Goal 5: Build and maintain the transportation system to facilitate economic development in the region		
5C1	Roadway geometry accommodates freight movement where it is needed.	To what extent does the alternative accommodate the design vehicle for designated freight routes? Measured by whether or not an alternative is able to accommodate the design vehicle.
5C2	Traffic operations performance on designated freight routes.	To what extent does the alternative provide acceptable performance along designated freight routes? Measured by operational performance along freight routes.
5C3	Potential increased attraction to desired businesses and developers.	To what extent does the alternative eliminate roadblocks to development caused by the transportation system? Measured by the critical transportation improvements funded relative to Baseline.
Goal 6: Improve system performance by balancing mobility and access, particularly along main travel routes.		
6C1	Number of access points for motorists based on street classification and desired street character.	To what degree does the alternative provide connectivity that enables the street to better reflect reasonable access spacing given its classification and desired operations? Measured relative to existing access conditions.
6C2	Estimated number of future crashes along the corridor.	To what degree does the alternative reduce the occurrence of crashes along key roadway corridors? Measured by the expected number of crashes along key corridors relative to Baseline.
6C3	Estimated MMLOS performance along the corridor.	To what extent does the alternative improve MMLOS performance along key corridors? Measured by the MMLOS performance along key corridors relative to Baseline.
6C4	Access provided for freight, bicyclists, and pedestrians.	To what extent does the alternative provide access for freight, bicyclists, and pedestrians while balancing mobility? Measured by the access and mobility balance provided for all modes of travel relative to Baseline.
Goal 7: Minimize the impacts of transportation system development on the natural and built environment.		
7C1	City-wide VMT and vehicle hours traveled.	To what extent does the alternative provide for alternative modes, enhanced connectivity, and improved land-use integration thereby reducing vehicle miles traveled? Measured by potential VMT reduction relative to Baseline.
7C2	Prevailing (i.e., 85 th percentile) corridor travel speed on major thoroughfares compared to the desired operating speeds given roadway function, class, and desired character.	To what extent are prevailing corridor travel speeds consistent with desired travel speed? Measured by the degree to which prevailing corridor travel speeds are consistent with desired travel speeds.
7C3	Travel mode split.	To what extent does the alternative reduce the reliance on auto trips? Measured by area-wide travel mode split.
7C4	Effectiveness of City design standards to limit the environmental impact of the transportation system.	To what extent do City design standards encourage designs that reduce the environmental impact of the transportation system? Measured relative to Baseline design standards.

7C5	Vehicle occupancy along commuting corridors during the peak periods.	To what extent does the alternative create opportunities for travelers to participate in rideshare programs and thereby increase vehicle occupancy? Measured by potential vehicle occupancy during the peak periods.
7C6	Installation of ITS devices.	To what extent are ITS devices being utilized for system improvements? Measured by the use of ITS devices relative to Baseline.
7C7	Compatibility of the transportation system and adjacent land use.	To what extent does the transportation system support the existing or desired land use mix in the area? Measured by the design speed, roadway cross-section, and modal facilities available relative to adjacent land use.
7C8	Compatibility of planned future improvements and available funding.	To what extent do the planned improvements for the alternative match the expected available funding? Measured by expected available funds for improvements compared to expected costs of planned improvements.

We look forward to discussing the draft goals, objectives and evaluation criteria presented above with you in more detail. Further discussion will occur at our June 13, 2012 Project Advisory Committee/Technical Advisory Committee meeting to introduce these materials. Comments can be provided at the meeting or following the discussion. Please provide all comments to Scott Edelman for collection and compilation at City Hall or via email (sedelman@cityofprineville.com). Commenting is also available on the project website (<http://sites.kittelson.com/PrinevilleTSP/Forums>). Based on the comments received, we will revise the goals, objectives, and evaluation criteria to produce a final set that will be applied as the Prineville TSP update moves forward.

Section 3
Technical Memorandum 3: Existing Conditions Inventory





CITY OF PRINEVILLE TRANSPORTATION SYSTEM PLAN



TECHNICAL MEMORANDUM #3: SYSTEM INVENTORY

This memorandum provides a summary of the existing transportation infrastructure in the City of Prineville. This inventory will be helpful in establishing system needs and strategies for the planning horizon (through 2035). Information presented herein was obtained and assembled using data provided by the City of Prineville, Crook County, and the Oregon Department of Transportation (ODOT).

STUDY AREA

The Transportation System Plan generally focuses on the areas within the Urban Growth Boundary (UGB), as shown in Figure 3-1. The TSP also includes lands just outside the UGB for the purposes of evaluating an alternative route near Juniper Canyon (locally referred to as “Brummer Road”) that could help alleviate traffic on streets within the UGB.

LAND USE AND POPULATION INVENTORY

An understanding of existing land use patterns and of a potential development scenario for the next 20 years provides information on future travel patterns within the UGB and the infrastructure that is needed to support the future economic growth of the city. In addition, an understanding of the location of existing and future residents to major activity centers, such as schools, commercial, civic uses and major employment areas, helps to shape multimodal facility planning. Figure 3-2 shows existing land uses and activity centers within the UGB. Appendix A includes housing density and existing employment density figures.

As shown in Figure 3-2, key destinations within the city include:

- Schools (Crook County High School, Crook County Middle School, Crooked River Elementary, Cecil Sly Elementary, Ochoco Elementary, Pioneer High School)
- Pioneer Memorial Hospital,
- Crook County Library,
- Central Oregon Community College – Crook County Open Campus,
- Ochoco Creek Park (Skateboard Park and Swimming Pool),
- Crook County Fairgrounds,
- Commercial uses within the downtown and along N 3rd Street

Analysis of the key destinations and their proximity to existing transportation infrastructure as well as existing neighborhoods and employment centers revealed the following issues for consideration:

- The schools are all located on the south side of US 26 whereas the residences are located both to the north and south of the highway. Providing a Safe Routes to School program is and will continue to be important to the community.
- Many of the parks and recreational opportunities are also located on the south side of US 26.
- The commercial lands are almost all located within 1 to 2 blocks of US 26. Establishing strong pedestrian and bicycle connections between these areas and the existing and future residents is important for providing transportation options within the city.
- The majority of the employment lands are not located within a reasonable walking or cycling distance of existing and future residents. Providing carpooling, transportation demand management and other multimodal strategies will help provide sustainable transportation options and support future economic development.

Several key areas of Prineville are expected to redevelop with commercial, industrial, and/or residential uses over the study period, as indicated in Figure 3-2, including:

- Ochoco Lumber site (SE quadrant of N 3rd Street and Combs Flat intersection)
- Lamonta Road (commercial/industrial land surrounding corridor west of Main Street)
- Tom McCall Industrial (industrial lands surrounding the Prineville airport north and south of OR 126)
- Iron Horse (planned unit development in northeast portion of City)
- Anglers Canyon/River Steppes (planned unit development south on Main Street)

City of Prineville staff have estimated future forecasts of residential and employment growth for the next twenty years. This information will be used to develop estimates of future transportation system demand and roadway traffic volumes. Additional details on the existing housing and employment densities are shown in *Appendix A*.

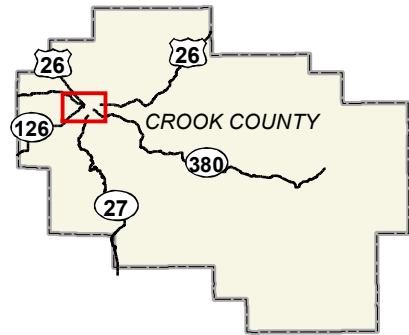

- City Boundary
- Study Area/Urban Growth Boundary (UGB)

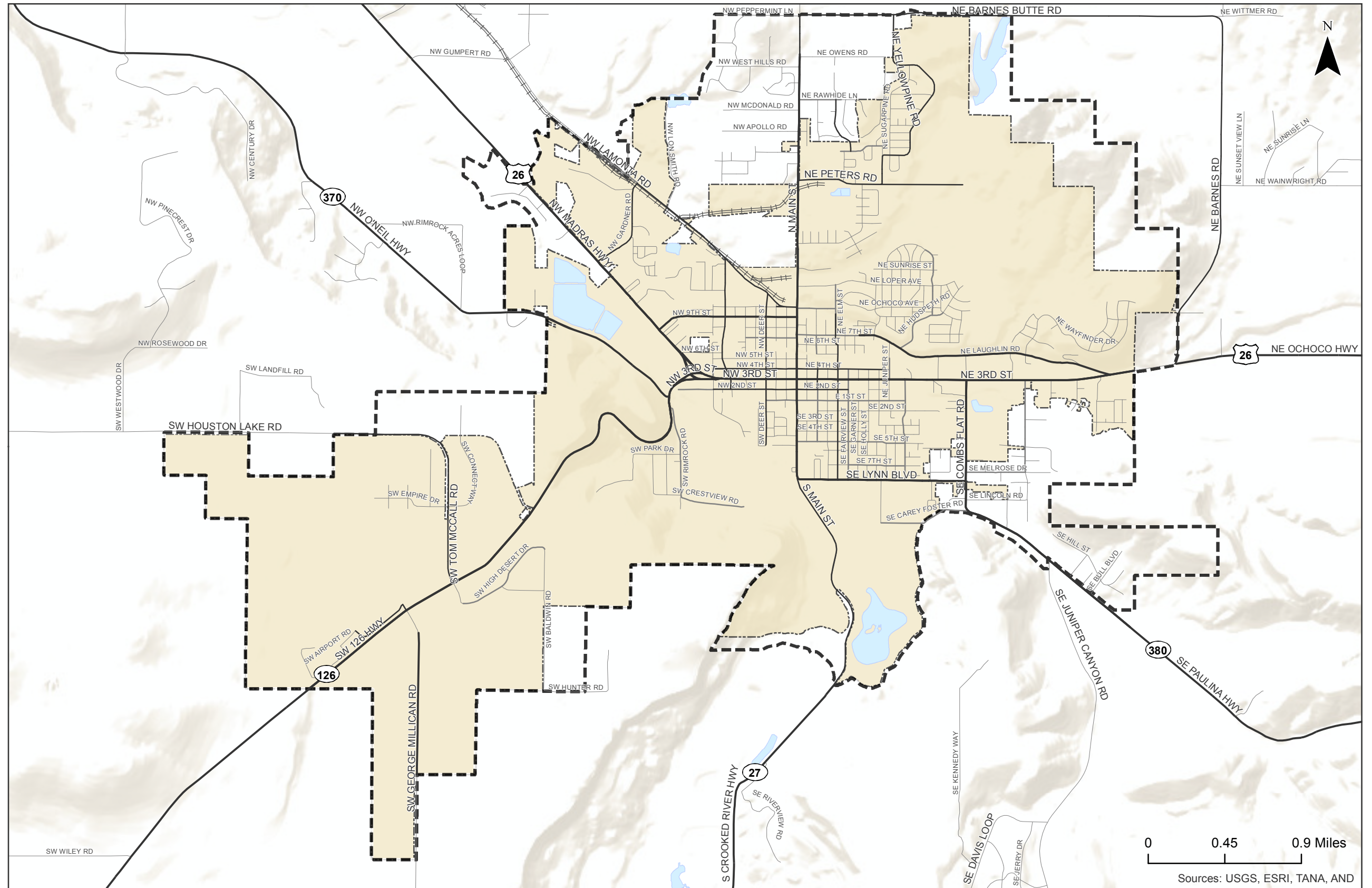

Sources: USGS, ESRI, TANA, AND

Study Area
City of Prineville, Oregon

Figure
3-1

K:\H_Perland\proj\12221 - Prineville TSP\GIS\Memo 3.9-1 Study Area.mxd - cbeigh - 6:52 PM, 2/22/2013

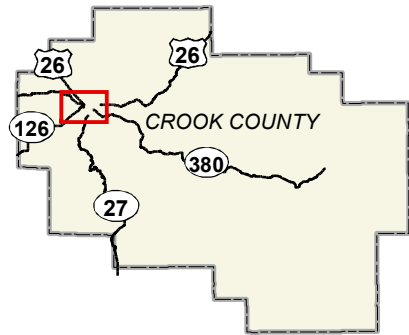

Destinations

- Airport
- Fairgrounds
- Golf Course
- Hospital
- Library
- Pool
- School
- Skatepark
- Park
- City Boundary
- Study Area/Urban Growth Boundary (UGB)

Zoning

- Airport
- Commercial
- Industrial
- Heavy Industrial
- Residential
- Rural Residential
- Suburban Residential Mobile
- Park Reserve
- Exclusive Farm Use

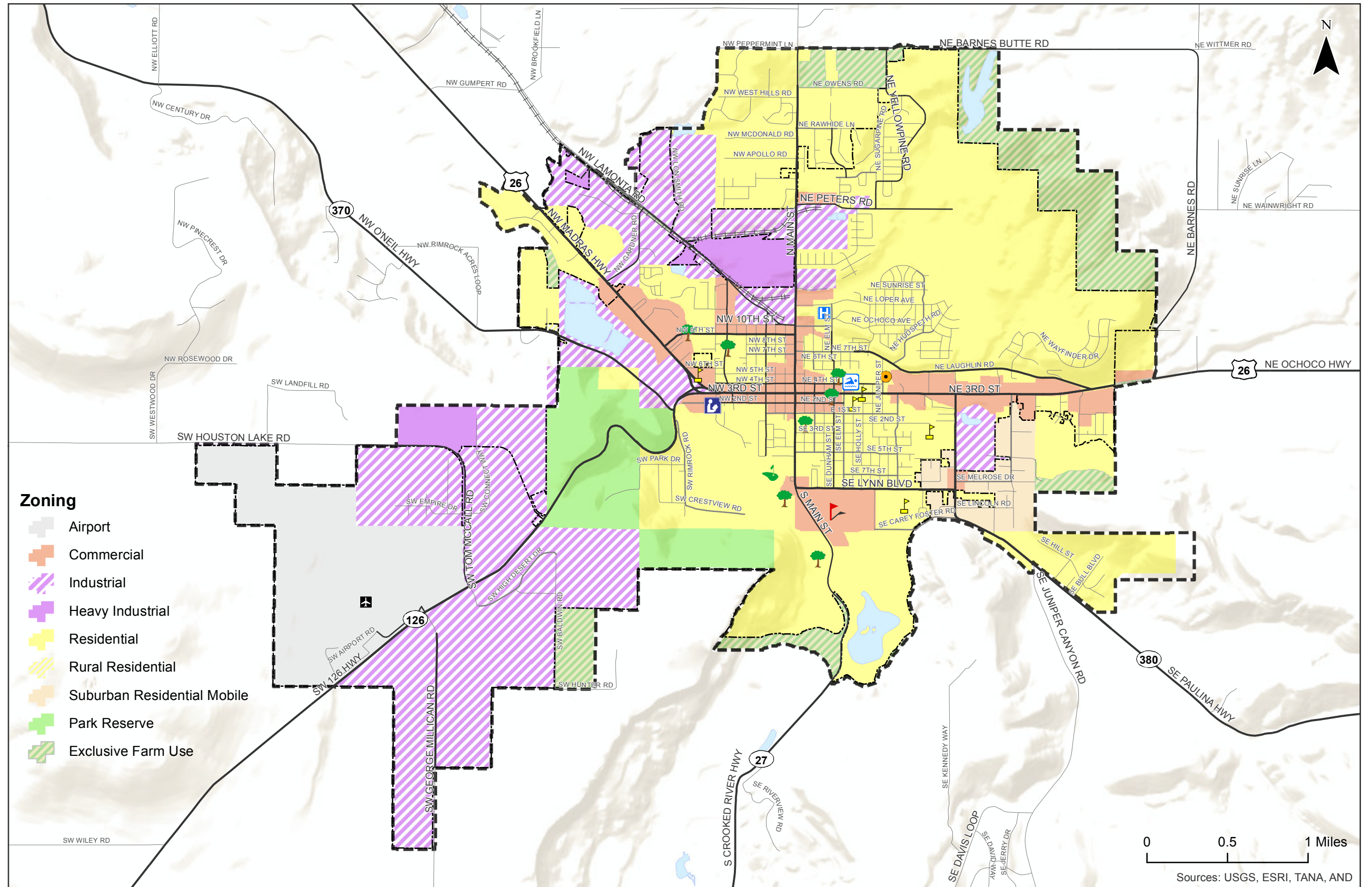

Sources: USGS, ESRI, TANA, AND

**Existing Land Use and Activity Centers
City of Prineville, Oregon**

**Figure
3-2**

H:\projects\12221 - Prineville TSP\gis\Memo 313-2 Existing Land Use and Activity Centers.mxd - 11:50 AM 2/14/2013

TRANSPORTATION SYSTEM INVENTORY

The City of Prineville’s transportation system includes facilities serving all modes of travel. The existing facilities provided by each mode are briefly outlined below and described in further detail within the appendices.

Roadway System Inventory

The City of Prineville is served by a network of City, County and State roadways. These roadways are classified by the function that they serve relative to adjacent land uses, expectation of mobility versus accessibility, and the multimodal facilities that are included within the right-of-way.

Five State highways serve Prineville, including US 26 from Madras, OR 370 (O’Neil Highway) from north Redmond, OR 126 (Ochoco Highway) from Redmond/Bend, OR 380 (Combs Flat Road – Paulina Highway) to Juniper Canyon and recreation sites, and OR 27 (Main Street) to scenic areas and Highway 20 (Bend/Burns). All of these highways are connected along N 3rd Street through the City’s downtown core. Existing highway classifications are shown in Figure 3-3 and Table 3-1. ODOT’s highway classifications provide guidance on the level of mobility and access provided along each roadway. More information on the mobility targets and access management standards for each facility is provided in Technical Memorandum #2.

Table 3-1 State Highway Functional Classification

Route Name (Hwy #)	Description	Highway Classification	NHS	Freight/Truck Route	Special Designations
US 26 Ochoco Hwy (41) Madras Hwy (360)	East of Prineville "Y" West of Prineville "Y"	Statewide Regional	Yes No	No Yes	STA ¹ None
OR 27, Crooked River Hwy (14)	Outside City Limits	District	No	No	None
OR 126, Ochoco Hwy (41)	Entire Segment	Statewide	Yes	Yes	EXP ²
OR 370, O’Neil Hwy (370)	Entire Segment	District	No	No	None
OR 380, Paulina Hwy (380)	Entire Segment	District	No	No	None

NHS = National Highway System

¹ STA= Special Transportation Area – from Milepost 18.24 to 19.38

² EXP= Expressway - from Milepost 1.37 to 17.92

The City and County have designated functional classifications for all non-state roadways in their respective TSPs. Key north-south arterials and collectors include Harwood Avenue, Main Street, and Combs Flat Road. Key east-west arterials and collectors include Lamonta Road, N 10th Street, N 3rd Street, N 2nd Street, and Lynn Boulevard.

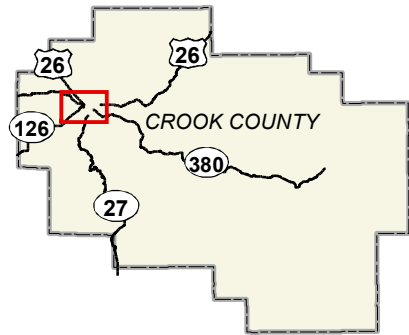

Functional Roadway Classifications

- Arterials
- Collector
- Local Route

State Highway Classifications

- Statewide
- Regional
- District
- City Boundary
- Study Area/Urban Growth Boundary (UGB)

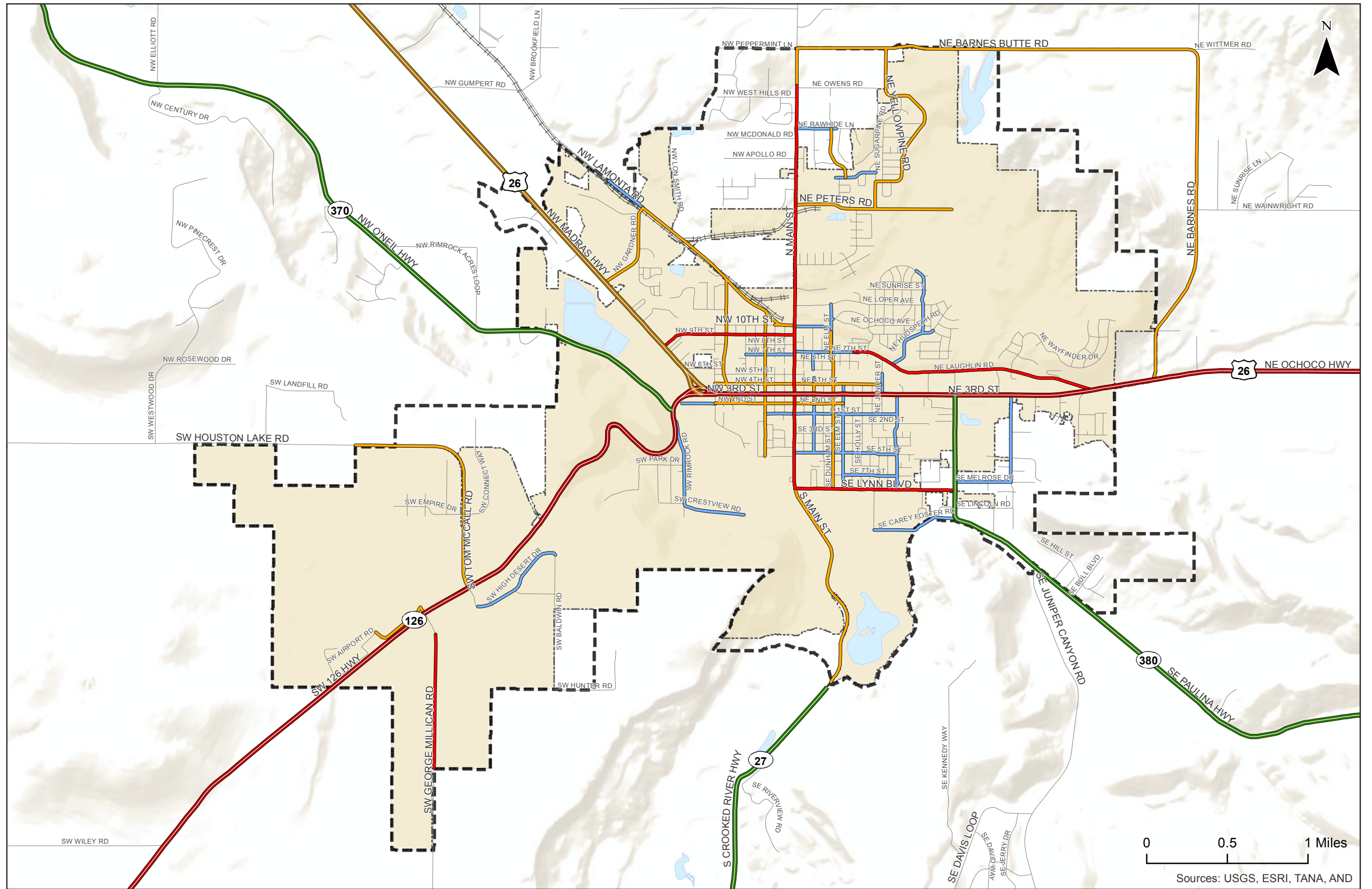

Sources: USGS, ESRI, TANA, AND

**Existing Functional Classification
City of Prineville, Oregon**

**Figure
3-3**

H:\projects\12221 - Prineville TSP\gis\Memo 313-3 Existing Functional Classification.mxd - jsummeville - 11:50 AM 2/14/2013

Pedestrian and Bicycle System Inventory

The existing pedestrian network is well developed in the downtown area and in newer developments throughout the city. However, several gaps exist in key pedestrian routes, including connections along Main Street and Combs Flat Road, and around priority areas such as schools. The Safe Routes to School Action Plans, developed by the City, identify locations on N 3rd Street where improved pedestrian crossings are needed. Figure 3-4 illustrates the pedestrian facilities based on GIS data provided by the Crook County GIS Department and the City of Prineville.

Based on the information presented in Figure 3-4, there are a number of gaps in key pedestrian routes, such as:

- Main Street north of train tracks to City boundary – connect residential neighborhoods to downtown.
- Lynn Boulevard from Southeast Combs Road to S. Main Street – provide connections to high school and middle school.
- Sidewalks on Southeast Combs Flat Road – provide a connection on a route from residential to commercial.
- Additional continuous north-south connection from N 4th Street to Lynn Boulevard (e.g., Fairview Street) – provide connection between residential areas north of N 3rd Street and east of Main Street to high school and middle school on Lynn Boulevard.

Bicycle facilities shown in Figure 3-5 represent multiple types of bikeways, including:







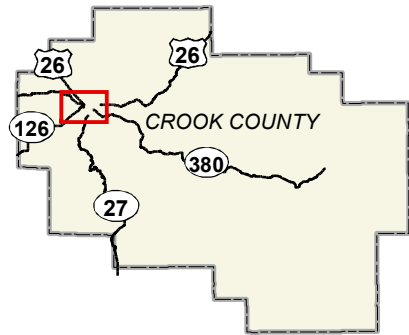







- Bike Lanes - a portion of the roadway is designated for preferential use by bicyclists; designated by pavement markings and signage.
- Bike Route – paved shoulder provides a suitable area for bicycling; not consistently marked or signed, but representative of primary routes.
- Multi-use Path – off-street route for non-motorized travel.

As shown in Figure 3-7, the following gaps are present along key bicycle routes within the city:

- Bike lanes along Main Street between S 3rd Street and Peters Road – connect residential neighborhoods to downtown.
- Bike lanes along N 3rd Street between the Prineville “Y” and Juniper Street – provide a consistent east-west route for cross-town travel.
- Widen shoulder bikeway to provide 6-foot wide bike lanes along Southeast Combs Flat Road between Southeast Lynn Boulevard and N 3rd Street – provide connection on a route from residential to commercial on N 3rd Street.
- Designate a network of local streets as shared roadways and provide pavement marking and signage to support bicyclist use. The wide pavement width along many of the older sections of the City could easily serve this purpose as designated bicycle lanes.



Destinations

-  Airport
-  Fairgrounds
-  Golf Course
-  Hospital
-  Library
-  Pool
-  School
-  Skatepark
-  Park
-  Existing Sidewalks
-  Multi-Use Path
-  Future Multi-Use Path
-  City Boundary
-  Study Area/Urban Growth Boundary (UGB)

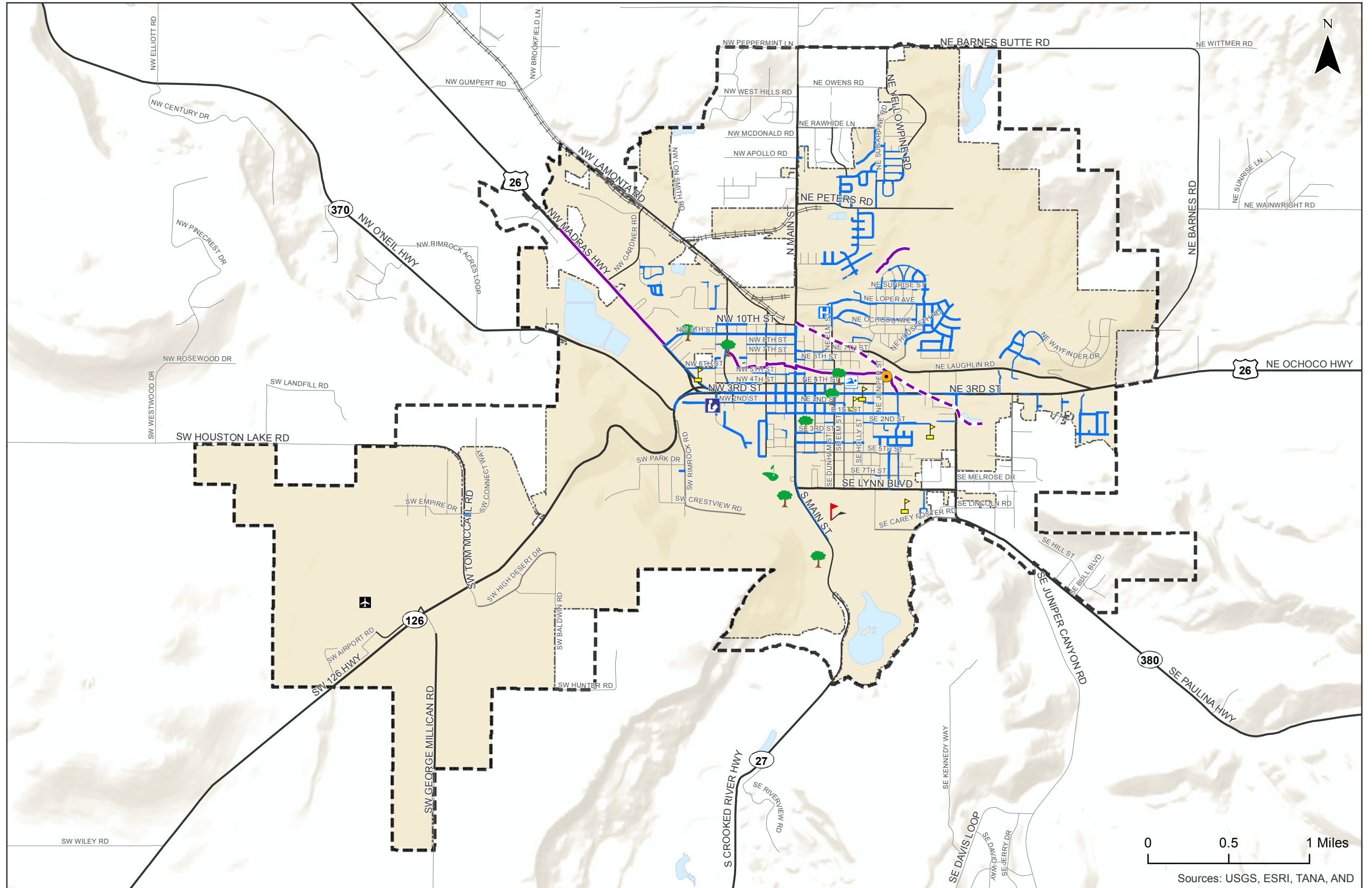

Sources: USGS, ESRI, TANA, AND







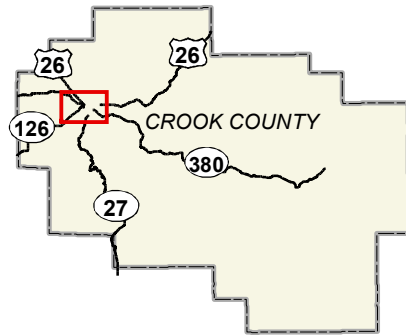







**Existing Pedestrian Facilities
City of Prineville, Oregon**

**Figure
3-4**

H:\proj\12221 - Prineville TSP\GIS\Memo 313-4 Existing Pedestrian Facilities.mxd - 11:51 AM 2/14/2013



Destinations

-  Airport
-  Fairgrounds
-  Golf Course
-  Hospital
-  Library
-  Pool
-  School
-  Skatepark
-  Park
-  Bike Route
-  Bike Lane
-  Multi-Use Path
-  Future Multi-Use Path
-  City Boundary
-  Study Area/Urban Growth Boundary (UGB)

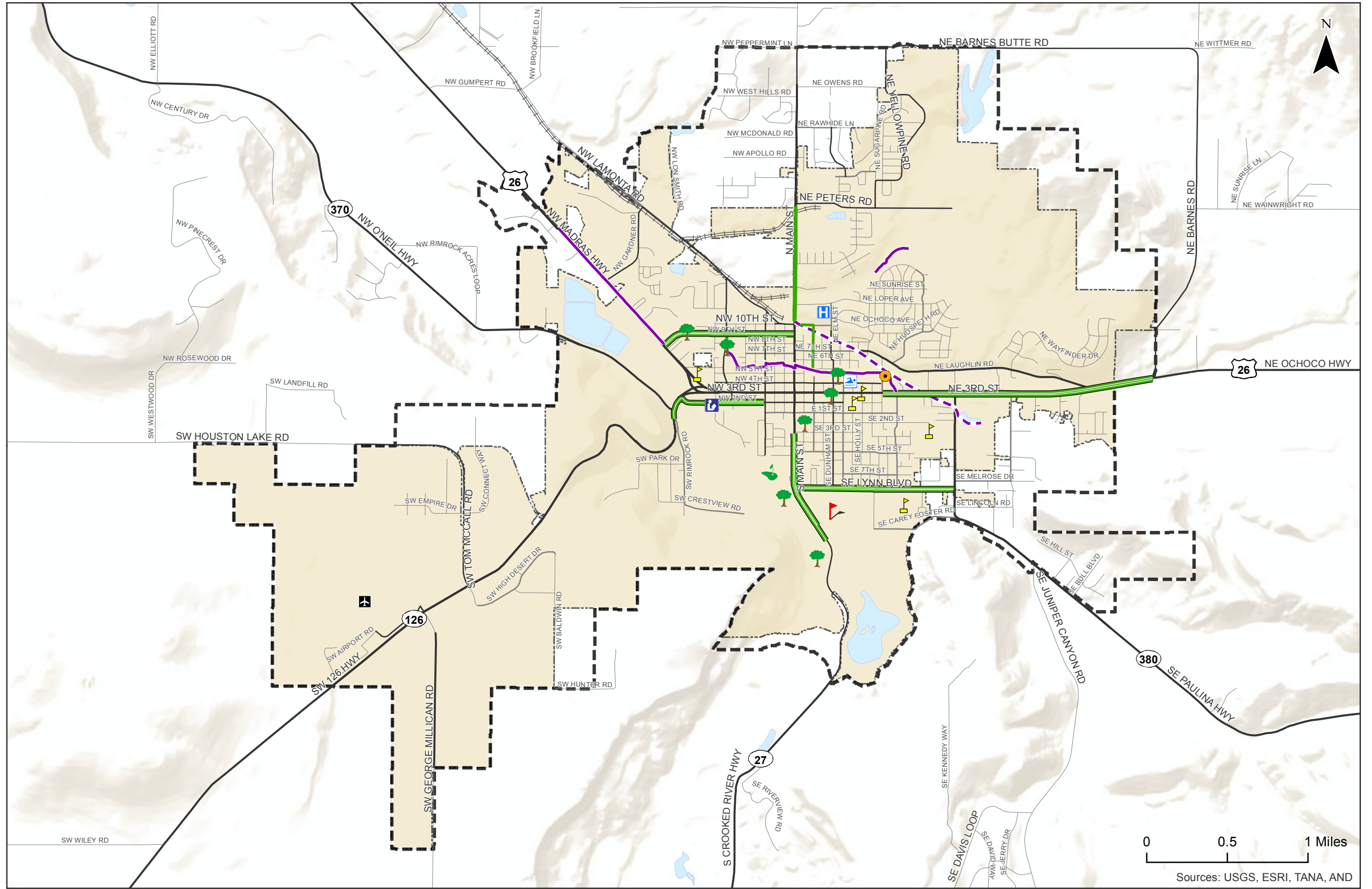

0 0.5 1 Miles

Sources: USGS, ESRI, TANA, AND

Existing Bicycle Facilities City of Prineville, Oregon

Figure 3-5

H:\p\112221 - Prineville TSP\GIS\Memo_315-5_Existing Bicycle Facilities.mxd - jommerville - 11:51 AM 2/14/2013

Public Transportation Inventory

Public transportation is provided to residents of Prineville by Cascades East Transit (CET). CET provides regional transit service from Prineville to Redmond on weekdays from 7:00 a.m. to 5:30 p.m. Within Prineville bus stops are provided at Stryker Park and the Park-and-Ride facility located on the west side of the Prineville “Y” junction. From Redmond, transfers can be made to fixed routes that connect to Bend, Madras, La Pine, Culver, Metolius, and Sisters. Standard fare is \$3.75, with discounts available for seniors and/or disabled, or when purchasing multi-trip passes.

Within Prineville, demand responsive services are available when scheduled 24-hours in advance by calling 541-385-8680. Additional information can be found at www.cascadeseasttransit.com.

Freight/Rail Transportation Inventory

The Oregon Highway Plan designates OR 126 and US 26 (Ochoco Highway section) as *State Highways* and *Freight Routes*. Figure 3-6 illustrates the location of the freight routes.

The City of Prineville Railway (COPR) operates a Class III shortline freight rail service. The freight service carries a variety of products including consumer and forest products, chemicals, and building materials. Service operates on an as-needed basis Monday through Friday. The train operates at 10 to 20 miles per hour. The tracks are in good condition with the main line meeting Federal Rail Administration (FRA) Class 2 standards. The COPR shortline connects with Class 1 railroads in Redmond on the Oregon Trunk Line that runs from the Columbia River to Klamath Falls.

The existing freight rail line ends west of the Main Street/10th Street intersection north of the downtown area. The Prineville Freight Depot (PFD) is intended to compliment the services offered by the COPR. It is located adjacent to the COPR mainline, three miles west of Prineville. The PFD provides a regional multi-modal transportation hub that provides Central Oregon with transload, reload, storage, and managed distribution.

Figure 3-6 also illustrates the rail lines in Prineville. There are five at-grade public crossings within Prineville city limits. Three crossings will influence future roadway improvements. An industrial spur crosses McKay Road that could potentially impact redesign of the McKay Road/Peters Road intersection and future connector to Lamonta Road.

As shown in Exhibit 3-1, the main line crosses Lamonta Road near NW Harwood Ave. This is a long-angled crossing which presents significant construction and maintenance cost as well as creating a potential hazard to motorcycles and bicyclists. This crossing is in need of reconstruction to correct subgrade, drainage and surface problems.





The Gardner Road crossing adjacent to its intersection with Lamonta Road presents a queue issue where large vehicles stopped waiting to enter Lamonta Road do not have adequate space to clear the rail line.

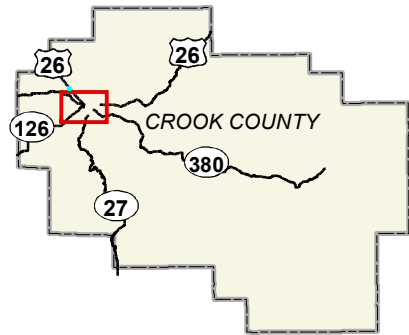
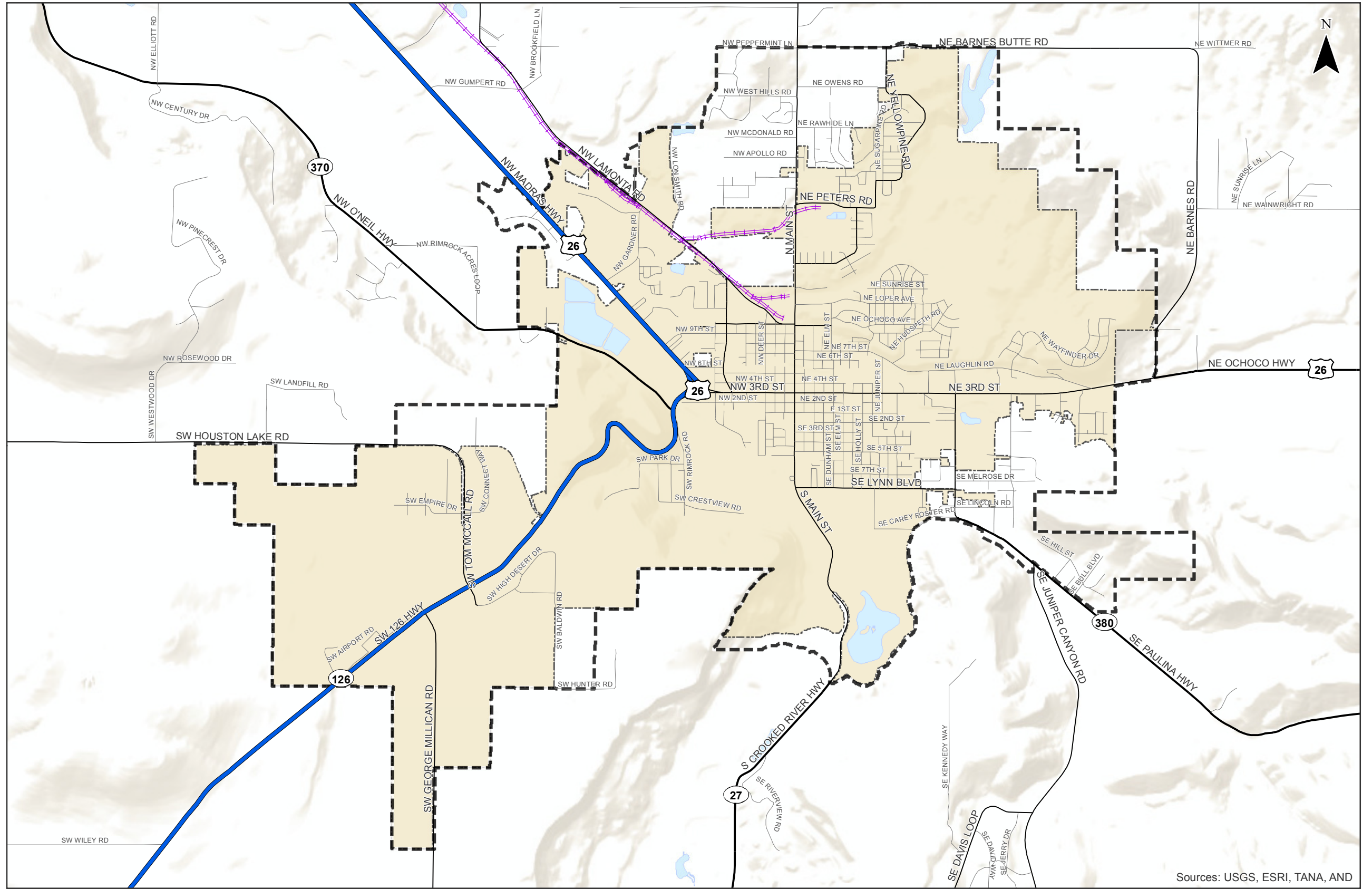

Exhibit 3-1: Railroad Crossing on Lamonta Road near NW Harwood Avenue. (Google Streetview Image)

There are no passenger rail services within the city limits of Prineville. The nearest passenger rail station operated by Amtrak is in Chemult, Oregon. Prineville residents can take a bus from the Redmond Airport to the Chemult rail station.



-  Freight Routes
-  Railroad
-  City Boundary
-  Study Area/Urban Growth Boundary (UGB)



Sources: USGS, ESRI, TANA, AND

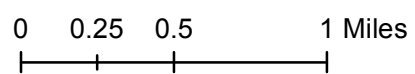

**Existing Freight Routes and Rail Transportation Facilities
City of Prineville, Oregon**

**Figure
3-6**

H:\proj\12221 - Prineville TSP\gis\Memo 313-8 Existing Freight Routes and Rail Transportation Facilities.mxd - jommerville - 10:47 AM 12/31/2012

Air Transportation Inventory

The Prineville/Crook County airport occupies 940 acres of land and is located approximately three miles SW of the City of Prineville. It is primarily used by corporate light jet and turbine traffic for general aviation/business purposes, but also facilitates fire support helicopters and fixed wing operations.

The airport has main and secondary runways, both are paved. The main runway (28-10) is 5,750 feet long by 75 feet wide and, according to a January 2013 report by the Federal Aviation Administration (FAA), is in “good” condition. The secondary runway (33-15) is 4,000 feet long by 40 feet wide and is in “fair” condition according to the 2013 FAA report.

The airport is a part of the National Plan of Integrated Airport Systems (NPIAS), making it eligible for federal funding. The Oregon Department of Aviation prepared a report on the Prineville Airport based on conditions observed in 2007. Per the aviation report, the airport is classified as a Category IV – Local General Aviation airport. The aviation report identified the installation of taxiway lighting as an airport facility and service need, based on minimum and desired criteria for a Category IV airport, but it has not been installed.

CONCLUSIONS

Based on the existing transportation and land use inventory, the following are key findings for consideration as part of the development of future transportation system improvements:

- Several key areas of Prineville are expected to redevelop with commercial, industrial, and/or residential uses over the study period, as indicated in Figure 3-2. The anticipated development potential is reflected in estimates of housing and employment prepared by the City.
- Motorized transportation relies heavily on N 3rd Street for east-west travel. Five State highways provide connections from Prineville to Madras (US 26) Redmond (OR 126), Bend (OR 126), Juniper Canyon and recreation sites (OR 380), and Burns (OR 27). All of these highways are connected by N 3rd Street through the City’s downtown core.
- Existing pedestrian and bicycle facilities lack connectivity; additional routes could reduce reliance on motorized travel on N 3rd Street.
- Freight rail facilities operated by City of Prineville Railway (COPR) reduce reliance on the highways for freight transport.

TECHNICAL APPENDICES

The technical appendices that follow provide additional detail on the transportation inventory.

Appendix A Land Use and Population Inventory

Appendix B Roadway System Inventory

Appendix A Land Use and
Population
Inventory

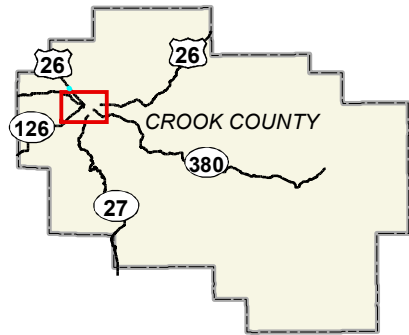

Households Per Acre

- 0 - 1
- 1.01 - 3
- 3.01 - 5
- 5.01 - 7
- > 9
- City Boundary
- Study Area/Urban Growth Boundary (UGB)

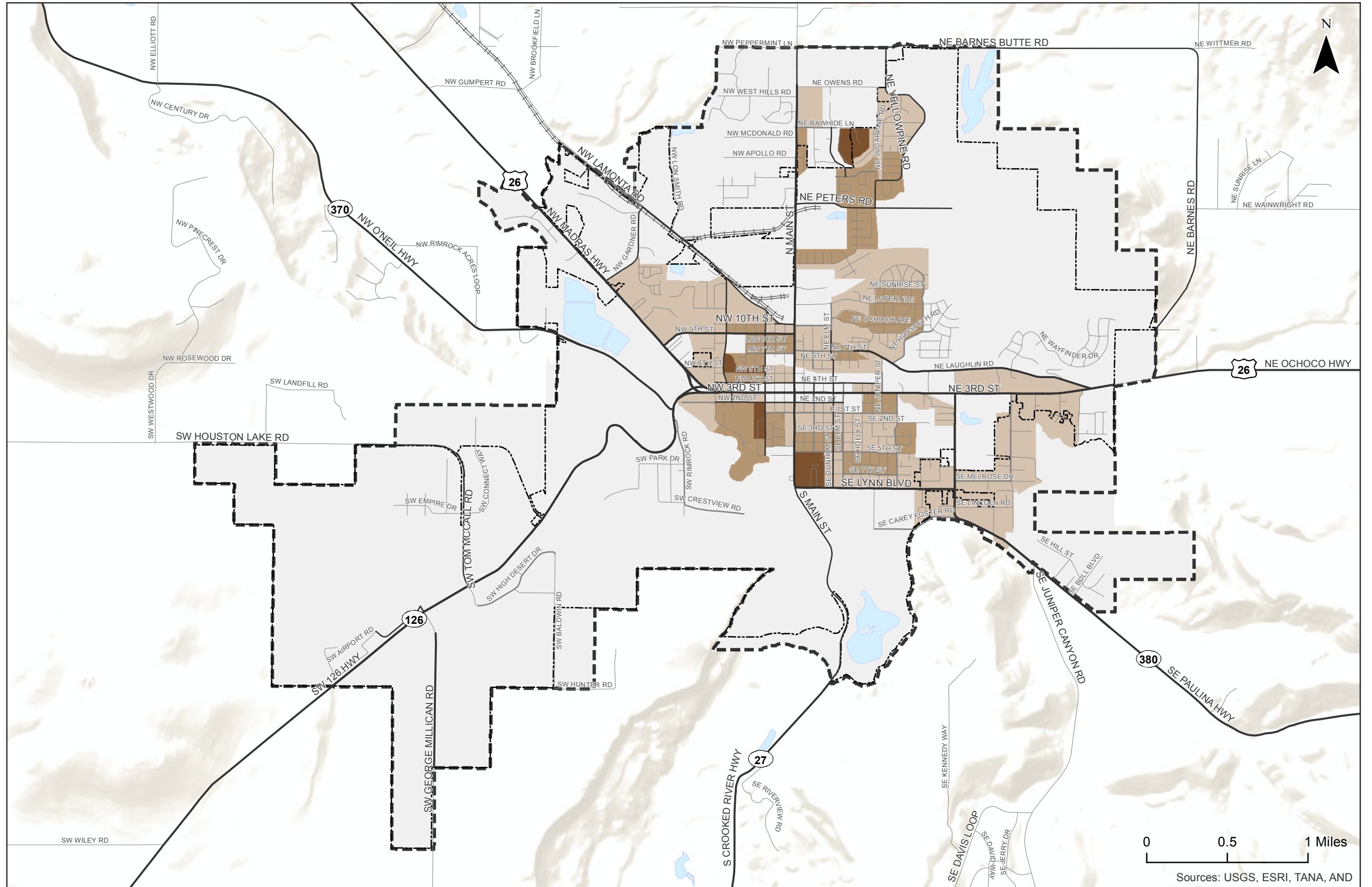

Sources: USGS, ESRI, TANA, AND

**Existing Housing Density
City of Prineville, Oregon**

**Figure
A-1**

H:\proj\112221 - Prineville TSP\gis\Memo 314-1 Existing Housing Density.mxd - 11:48 AM 2/14/2013

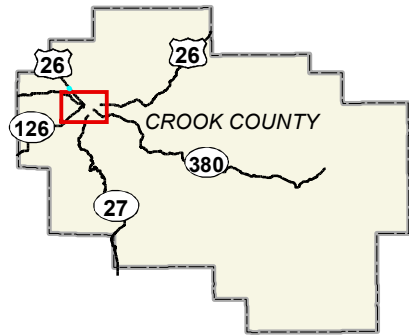

Employees Per Acre

- 0 - 1
- 1.01 - 3
- 3.01 - 6
- 6.01 - 12
- > 12

- City Boundary
- Study Area/Urban Growth Boundary (UGB)

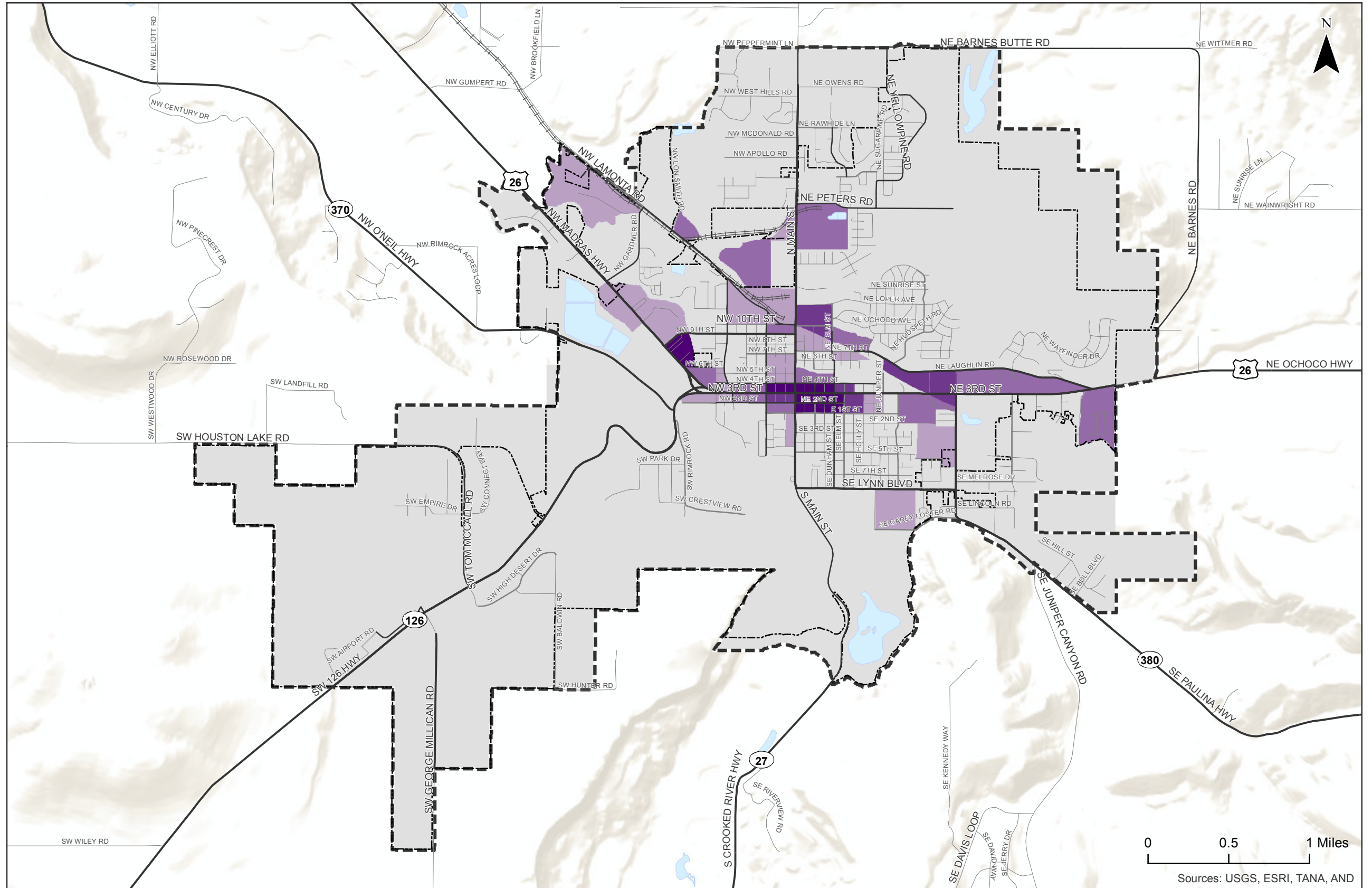

Sources: USGS, ESRI, TANA, AND

**Existing Employment Density
City of Prineville, Oregon**

**Figure
A-2**

H:\projects\12221 - Prineville TSP\gis\Memo 314-2 Existing Employment Density.mxd - jscummelle - 11:48 AM 2/14/2013

Appendix B Roadway System
Inventory

Prineville Bridge Inventory

The City of Prineville prepares annual inspection reports of the bridges within the city limits. Based on the inspections from the years of 2008 through 2011 there are no restrictions on any bridges with the exception of the Elm Street bridge. The Elm Street bridge has a load limitation based on the inventory rating of 4 tons. A full inventory of the bridge inspections is provided in Table 3-2.

Table 3-2 Prineville Bridge Inventory

Bridge (ID)	Sufficiency Rating	AC Depth	Length (feet)	Width (feet)	Operating Load*	Inventory Rating**	Posting	Inspection Date
Gardner Rd. (13C41)	96.9	6	96.0	32.0	63.05 tons	38.03 tons	No restrictions	12/8/2008
Harwood St. (20191)	96.7	2	69.0	53.0	75.00 tons	45.00 tons	No restrictions	12/11/2008
Deer St. (19631)	91.8	2	69.8	57.5	75.00 tons	45.00 tons	No restrictions	12/11/2008
9th St. (19633)	93	2	139.5	48.6	75.00 tons	45.00 tons	No restrictions	12/11/2008
Main St. (20190)	95.2	3	69.0	52.0	75.00 tons	45.00 tons	No restrictions	12/11/2008
Elm St. (013C39)	38.8	4	67.0	49.0	5.00 tons	4.00 tons	Posted for Load	7/5/2011
Juniper St. (18093)	83.2	1.5	53.0	44.0	75.00 tons	45.00 tons	No restrictions	12/11/2008
Combs Flat (07282)	43.1	7	34.0	39.5	46.00 tons	28.00 tons	No restrictions	12/10/2012
Highway 26 (20649)	96.7	0.00	48.0	77.3	105.00 tons	81.00 tons	No restrictions	1/15/2013

* Maximum load the bridge was designed to carry

** Acceptable daily load allowed without a permit

Sufficiency rating is a measure between 0 and 100 calculated by the Federal Highway Administration (FHWA), based on factors such as condition, materials, load capacity, and geometry (i.e., dimensions). The FHWA uses the rating as a tool to prioritize the allocation of funds for bridge repairs. In general, bridges with a sufficiency rating of less than 50 are given priority. There are two bridges in this category within Prineville’s transportation network, the Elm Street bridge and the Combs Flat bridge. For the past several years the City has been actively seeking funding to improve the Elm Street bridge. The Combs Flat bridge (on OR 380) is a state-owned facility.

STATE HIGHWAY SYSTEM CHARACTERISTICS

State highways are designated as Statewide, Regional, and District highways within the 1999 Oregon Highway Plan (OHP). Each state highway in the Prineville urban area was described in Table 3-1 and illustrated in Figure 3-3.

US 26 runs east-west connecting Prineville to Boise, Idaho and beyond to the east, and connects to Portland and beyond to the west. OR 126 also runs east-west and provides a connection to Redmond. OR 27 runs north-south connecting Prineville to US 20 to the south. OR 380 runs east-west, connecting Prineville with the town of Paulina. OR 370, also known as the O'Neil Highway, provides an alternate east-west route between Prineville and Redmond.

Within the UGB, US 26 joins OR 126 along the N 3rd Street alignment east of the "Y" as the Ochoco Highway, and changes to Madras-Prineville Highway west of the Prineville "Y". OR 27, the Crooked River Highway, becomes S Main Street within the City limits, and terminates at N 3rd Street. Main Street is no longer an ODOT facility within City limits following a jurisdictional transfer to the City. OR 380, also known as Paulina Highway, becomes Combs Flat Road within the UGB, also terminating at N 3rd Street.

Section 4
Technical Memorandum 4: Existing Conditions Analysis



CITY OF PRINEVILLE TRANSPORTATION SYSTEM PLAN



TECHNICAL MEMORANDUM #4: EXISTING CONDITIONS ANALYSIS

This memorandum discusses the current performance of Prineville's transportation system and highlights existing needs that can be addressed through future projects, policies and programs implemented by the City. This memo serves as a companion to Technical Memorandum #3: Existing Transportation Inventory and the current policies, and goals and objectives identified in Technical Memorandums #1 and #2.

MOTORIZED TRANSPORTATION

The performance of the street system is often quantified using three measures: Level of Service (LOS), volume-to-capacity (v/c) ratio, and 95th percentile queue lengths. The specific performance thresholds vary by jurisdiction, as indicated in Appendix B. These measures were calculated for 22 intersections on the city's collector and arterial roadways to provide an indication of the system performance as a whole. As discussed below, all 22 intersections analyzed meet City and ODOT performance measures, with the exception of the OR 126/Tom McCall Road intersection. Three other intersections meet applicable standards, but operate with higher levels of delay than other intersections in the city.

Traffic Data Collection and Volume Development

The weekday evening period was identified as the peak period for analysis. The peak period traffic volume data collection and development of design hour volumes is described below.

Turning movement volumes were obtained at study intersections (outlined in Appendix B, Table B-2) during the weekday evening peak period in April 2012. The evening peak period counts were conducted from 4 to 6 p.m., except at those intersections near schools that were counted from 2 p.m. to 6 p.m. Historic weekday p.m. peak hour counts were obtained from October 2010 at intersections on OR 126.

Individual intersection peak hours were identified for use in the traffic analysis to maintain a conservative analysis of the peak period, and to reflect peaking characteristics associated with schools near some study intersections. Summing all entering vehicles at all count locations shows that the use of individual intersection peak hours results in approximately five percent higher volume than if a consistent system peak hour were used.

The volumes were balanced on major corridors (e.g., N 3rd Street and Main Street), where individual intersection peak hours are consistent. The balanced volumes allow for some variation between intersections to account for driveway volumes between intersections.

A seasonal adjustment factor was calculated based on the On-site Automatic Traffic Recorder (ATR) method to develop 30th Hour Volumes (30 HV). Since there are no ATR stations within the Prineville UGB, seasonal adjustment factors were developed based on data collected at the two closest ATR stations – ATR Station 07-001 (on US 26, approximately 4.2 miles east of Main Street) and Station 07-002 (on OR 126, approximately 15.3 miles west of Main Street). The seasonal factors developed from data at ATR station 07-001 are not applicable to the TSP because traffic east of Prineville does not reflect commuter traffic between Prineville and Bend/Redmond, which accounts for a large portion of traffic in Prineville.

The seasonal adjustment factors calculated based on data collected at ATR station 07-002 for April and October were found to be 1.07 and 1.09, respectively.

An alternative method for calculating the seasonal factors is based on the ODOT Characteristics table for other 2- or 3-lane commuter facilities with an ADT between 10,000 and 14,000. Two ATR locations have these characteristics and have adjustment factors of 1.04 and 1.05 for April and October, respectively. The higher seasonal adjustment factors from the ATR on OR 126 (07-002) were used to maintain a conservative analysis.

The ATR data and seasonal adjustment factor calculations are included in Appendix A. All intersection level-of-service analyses were performed in accordance with the procedures stated in the 2000 *Highway Capacity Manual* (HCM, Reference 3). Through movements along OR 126 and US 26 were adjusted at each of the study intersections to reflect 30th highest hour design volumes. The design hour (seasonal adjustment) factors are based on 2008 and 2009 data obtained from Automatic Traffic Recorder (ATR) 007-02 located 0.35 miles west of the Deschutes/Crook County boundary. The seasonal adjustment allows the collected October counts to reflect peak summer season (July) conditions.

Applicable traffic count data, analysis methodologies, and operational standards/targets are summarized in *Appendix A and Appendix B*.



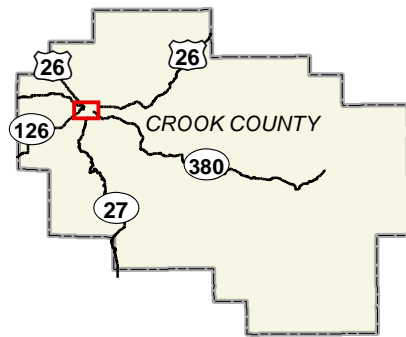

Intersection Delay and Capacity Analysis

Figure 4-1 illustrates the study intersection locations and existing traffic conditions relative to ODOT and City of Prineville mobility and level-of-service standards (see *Appendix B*). The intersections were rated red, yellow, and green, based on whether the applicable performance standards are met. The figure also identifies those intersections that operate at Level of Service “C” or better, which generally indicates minor delays and a user’s perception of minor levels of congestion during most times of the day. Detailed operational analysis results are summarized by intersection in Figure 4-2. Lane configurations are summarized by intersection in Appendix B. A description of level of service and the criteria by which they are determined is presented in Appendix B¹.

¹ Appendix “B” indicates how level of service is measured and what is generally considered the acceptable¹ range of level of service. Intersection level of service (LOS) is analogous to the letter grades in a school report card. Motorists using an intersection that operates at LOS “A” experience very little delay, while those using an intersection that operates at LOS “F” will experience intolerably long delays.



Study Intersections

-  Meets Standards, LOS "C" or Better
-  Meets Standards
-  Does Not Meet Standards
-  City Boundary
-  Study Area/Urban Growth Boundary (UGB)

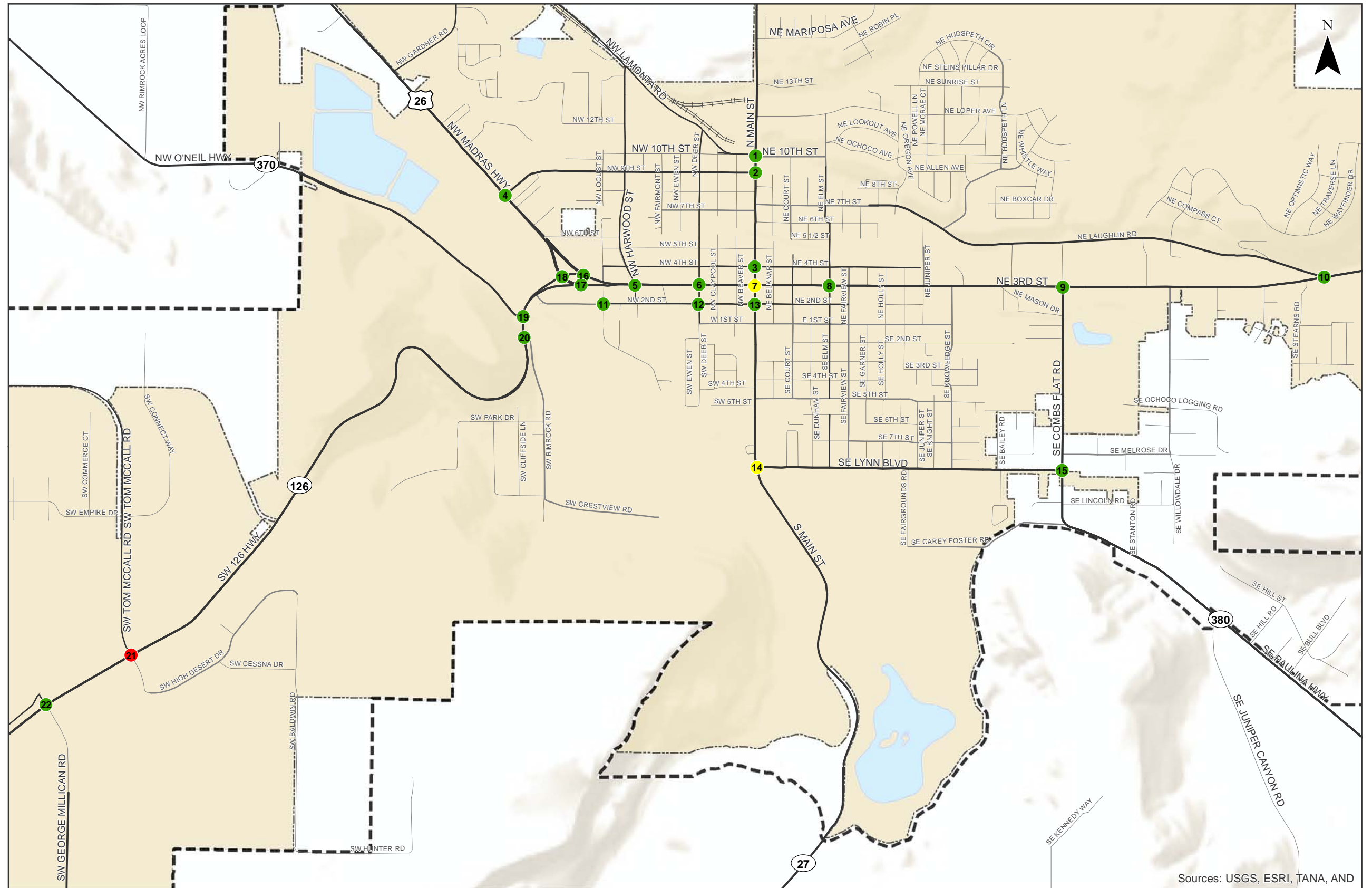

Sources: USGS, ESRI, TANA, AND

0 0.125 0.25 0.5 Miles

**Existing Traffic Conditions, Weekday PM Peak Hour
City of Prineville, Oregon**

**Figure
4-1**

H:\proj\112221 - Prineville TSP\gis\memo 4k-1 Traffic Conditions.mxd - opepdx - 2:04 PM 7/10/2013

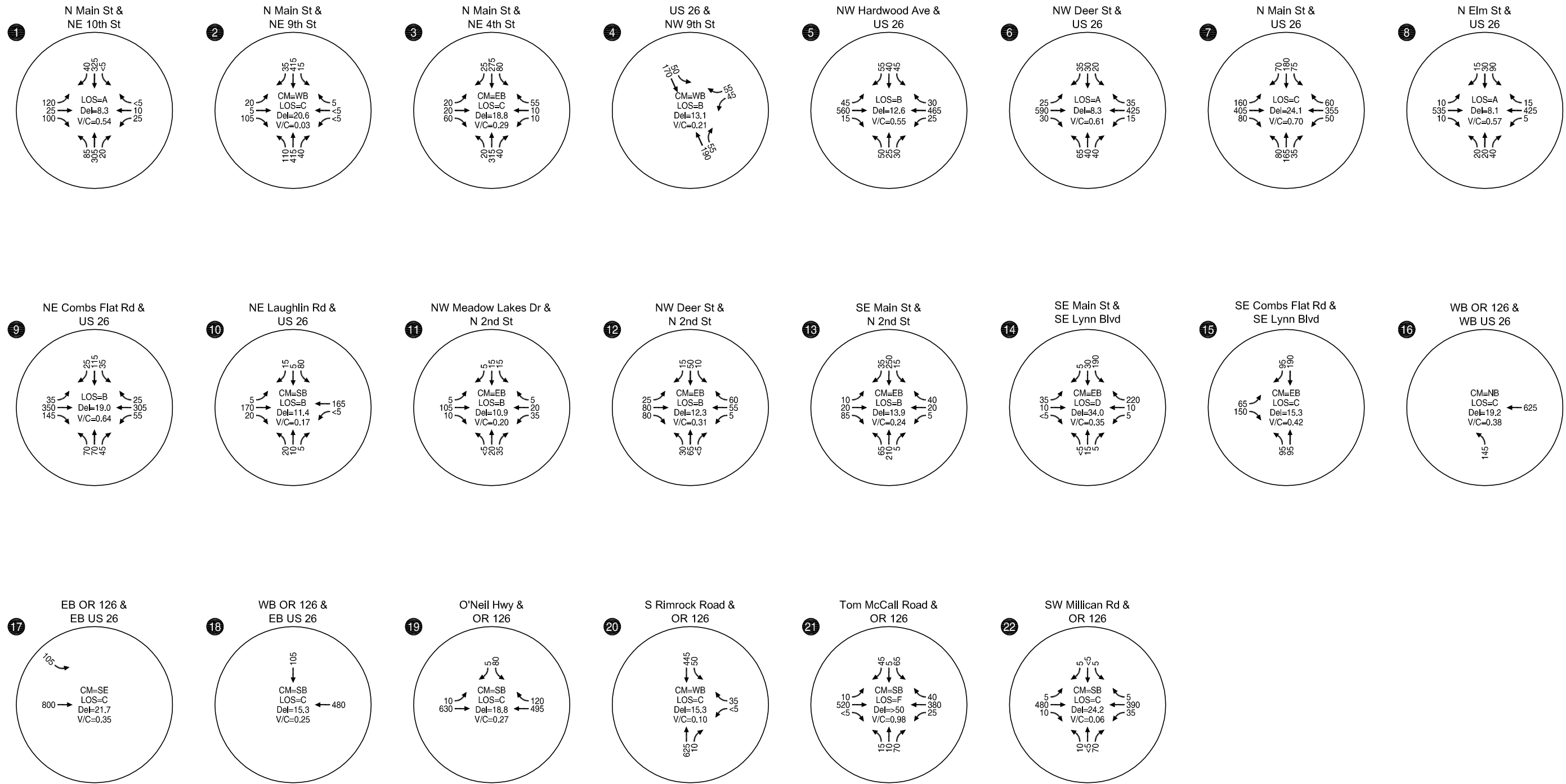

H:\proj\12221 - Prineville TSP\dwgs\figs\12221 Fig 01.dwg Aug 01, 2013 - 1:57pm - cbergh Layout Tab: C-2

DETAILED TRAFFIC ANALYSIS RESULTS
EXISTING WEEKDAY PM PEAK HOUR
PRINEVILLE, OR

Figure 4-1 and Figure 4-2 show that all study intersections, except the OR 126/Tom McCall Road intersection, meet the applicable mobility standards. The OR 126/Tom McCall Road intersection operates at LOS “F” and a volume-to-capacity ratio of 1.0 during the 30th highest hour, the critical time period during which the intersection performance is compared to City and ODOT standards. Traffic operations worksheets are provided in *Appendix C*.

To understand the number of hours the OR 126/Tom McCall intersection doesn’t meet standards, 16-hour traffic volume counts were obtained and analyzed. As shown in Exhibit 4-1, the intersection exceeds the ODOT mobility target (v/c ratio > 0.90) in the mid-afternoon (i.e., between 2:45 and 4:30 p.m.) and City and County standards (delay > 50 seconds) during the mid-afternoon and afternoon commute hours (i.e., between 2:45 to 4:30 p.m. and between 4:45 and 6:30 p.m.).

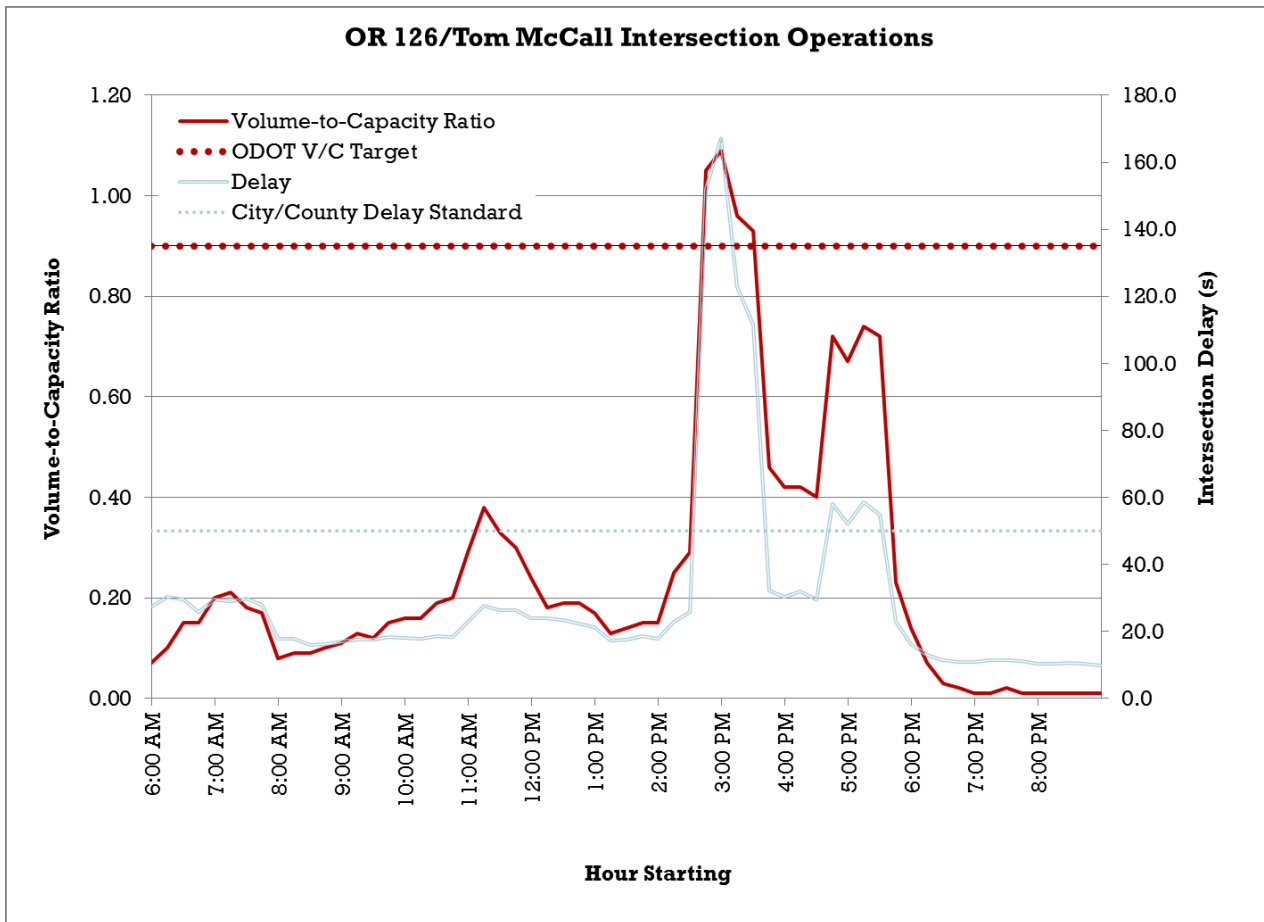

Exhibit 4-1. OR 126 and Tom McCall intersection performance throughout the 16-hour count period.

Intersection Queuing Analysis

Understanding how long, both in terms of length and time, queues of cars line up at intersections provide an indication of a user’s sense of congestion at a particular location. Intersection queuing analysis can also identify locations where the storage provided to accommodate those queues may need to be lengthened. To provide this understanding, queuing analysis was performed at the study intersections in accordance with the ODOT Analysis Procedures Manual (APM,1). The

95th Percentile queue lengths were calculated using Synchro 7 software, which implements the 2000 *Highway Capacity Manual* methodology (2).

Per this analysis, the N 3rd Street/Main Street intersection is the only intersection identified to have 95th percentile queues that exceed available storage capacity on one or more approaches. The remaining study intersections have adequate storage, though long queues were noted at several signalized intersections along N 3rd Street. *Appendix C* contains a summary of queuing analysis results for all study intersections.

ACTIVE TRANSPORTATION

Neither the City nor the state has adopted standards that can be used to assess the performance of the “active transportation system”. In lieu of standards, key gaps in the existing bicycle and pedestrian system were identified through a review of the Safe Routes to School (SRTS) Action Plans prepared by the City and its residents for three schools in Prineville and an assessment of the location of existing sidewalks and bicycle routes relative to popular/desired pedestrian and bicycle destinations (e.g., downtown, hospital, city parks, etc.).

SRTS Action Plans

The recommendations and strategies from SRTS Action Plans for Cecil Sly Elementary School, Crook County Middle School, and Crooked River Elementary School included a Safe Routes Segment Map, shown in *Appendix D*. The map shows seven preferred pedestrian and bicycle route “segments” that connect residential areas north of N 3rd Street to the schools on the south side of N 3rd Street.

As part of implementation of the Action Plans, the City has funded construction of sidewalks and curbs on the west and north side of the following segments:

- Segments #4 and #6 (NE Juniper Street) from E 1st Street to Laughlin Road
- Segment #3 (Laughlin Road) from Juniper Street to Hudspeth Road
- Segment #2 (Hudspeth Road) from Laughlin Road to Existing Sidewalk near Jordan Lane

Pedestrian Network

The existing pedestrian network is well developed in the downtown area and within private subdivisions in the northern part of the city. However, some pedestrian links that connect the northern developments to the central and southern part of town are missing, as confirmed by the SRTS Action Plans. Based on an analysis completed to determine the connectivity of existing pedestrian routes to destinations, the following sidewalk gaps were identified:

- *Main Street north of 10th Street to City boundary*: The addition of sidewalks along this segment of Main Street would provide a pedestrian connection between residential areas in the north part of the city and civic destinations, such as the pool, schools, and parks.

- *Lynn Boulevard from SE Combs Road to S Main Street:* The addition of sidewalks or a separated path would provide a safe pedestrian connection for students with the adjacent middle school, high school, Central Oregon Community College satellite campus, and access to the fairgrounds.
- *SE Combs Flat Road:* The addition of sidewalks along this segment will help serve students and surrounding residents along one of a limited number of north-south connections in the City. This infrastructure will also support future redevelopment of the Ochoco Lumber site and connect these areas north across N 3rd Street to shopping opportunities and ultimately to the Iron Horse property.
- *Fairview between Lynn Boulevard and N 3rd Street:* Filling in the sidewalk gaps on Fairview would provide a central north-south corridor.
- *NE 7th Street and Loper Avenue:* sidewalks along these streets would provide beneficial east-west connections across Prineville's northeast quadrant. To accommodate right-of-way, slope, utilities, and driveway issues, either of these roadways could be improved with a sidewalk along one side of the roadway.
- *Ochoco Creek Trail System:* the City plans to pave the trail between Harwood east to Main Street. Extension of this trail system across N 3rd Street and into a Combs Flat pedestrian system would link the northwest and southeast portions of the City, and has been considered previously by the City as part of a possible Rails-to-Trails project along the abandoned rail right-of-way.

Bicycle Network

The existing bicycle network in Prineville provides regional and some local connections. There is an existing bike route along N 3rd Street and Main Street which provide east-west and north-south regional connections, respectively. Based on an analysis completed to determine the connectivity of existing bicycle routes to key destinations, the following is a list of identified gaps of bike facilities with the associated justification:

- *Main Street between Davidson Park and NW 10th Street:* provision of bike lanes would complete a missing gap in the network and provide regional and local north-south connectivity.
- *Parallel east-west routes to N 3rd Street:* routing bicycles and providing bike lanes on 2nd Street or 4th Street could be considered. A off-street bike path that follows the N 3rd Street alignment could also key downtown bicycle connectivity needs.
- *SE Combs Flat Road:* a continuous bicycle facility from SE Lynn Boulevard north of N 3rd Street would provide connections into the planned Iron Horse development. This could be integrated with pedestrian needs as part of a mixed use trail system or a combination of sidewalks, trails, and bicycle lanes.

As part of developing an implementation plan for the TSP, pedestrian and bicycle transportation improvements will be prioritized. Prioritization will be based on project goals and objectives and take into account volume and roadway characteristics.

CRASH HISTORY

Over the five-year study period (January 1, 2007 through December 31, 2011), 415 crashes were reported within the Prineville UGB. Figure 4-3 illustrates crash locations by severity at study intersections. Roadway segment and intersection crash history is summarized in *Appendix E*.

The Highway Safety Manual (HSM) identifies several methods to identify crash sites with potential for crash reduction. Following review of these methods, the *critical crash rate method* was applied to Prineville intersections based on available data. This methodology takes into account traffic volumes and crash frequencies. The data and analysis are summarized in *Appendix E*.

Findings from the crash analysis indicate the following:

- Approximately 45 percent of reported crashes (188 crashes) occurred on state highways, and 94 percent of those occurred on Ochoco Highway (OR 126 west of the Prineville "Y" and US 26/OR 126 – N 3rd Street east of the Prineville "Y").
- No fatal traffic crashes were reported during the five year period.
- Nine pedestrian-involved crashes and eight bicyclist-involved crashes were reported over the 5-year period and all resulted in injuries. The locations of the crashes vary throughout the UGB.
- The Main Street/N 9th Street intersection has a crash rate of 0.33 crashes per million entering vehicles. This rate exceeds the statewide 90th percentile rate of 0.29 for similar intersections, as documented in *Assessment of Statewide Intersection Safety Performance*, prepared for ODOT and FHWA. Signal improvements are planned on Main Street at N 10th Street, which will change the crash patterns and reduce conflict points. No additional evaluation is necessary until the signal improvements are completed.
- The Deer Street/2nd Street intersection has a crash rate of 1.17 crashes per million entering vehicles. This rate exceeds the critical crash rate of 0.57 and the statewide 90th percentile rate of 0.41 for similar intersections. Of the 10 crashes reported at this intersection, eight resulted in injury.
- The N 4th Street/Main Street intersection has a crash rate of 0.71 crashes per million entering vehicles. This rate exceeds the critical crash rate of 0.47 and the statewide 90th percentile rate of 0.41 for similar intersections.

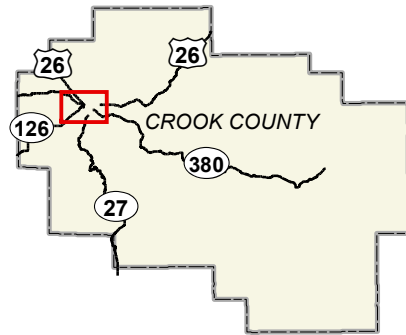

Crash Event Severity

- Non-fatal injury crash
- Property damage only crash (PDO)
- City Boundary
- Study Area/Urban Growth Boundary (UGB)

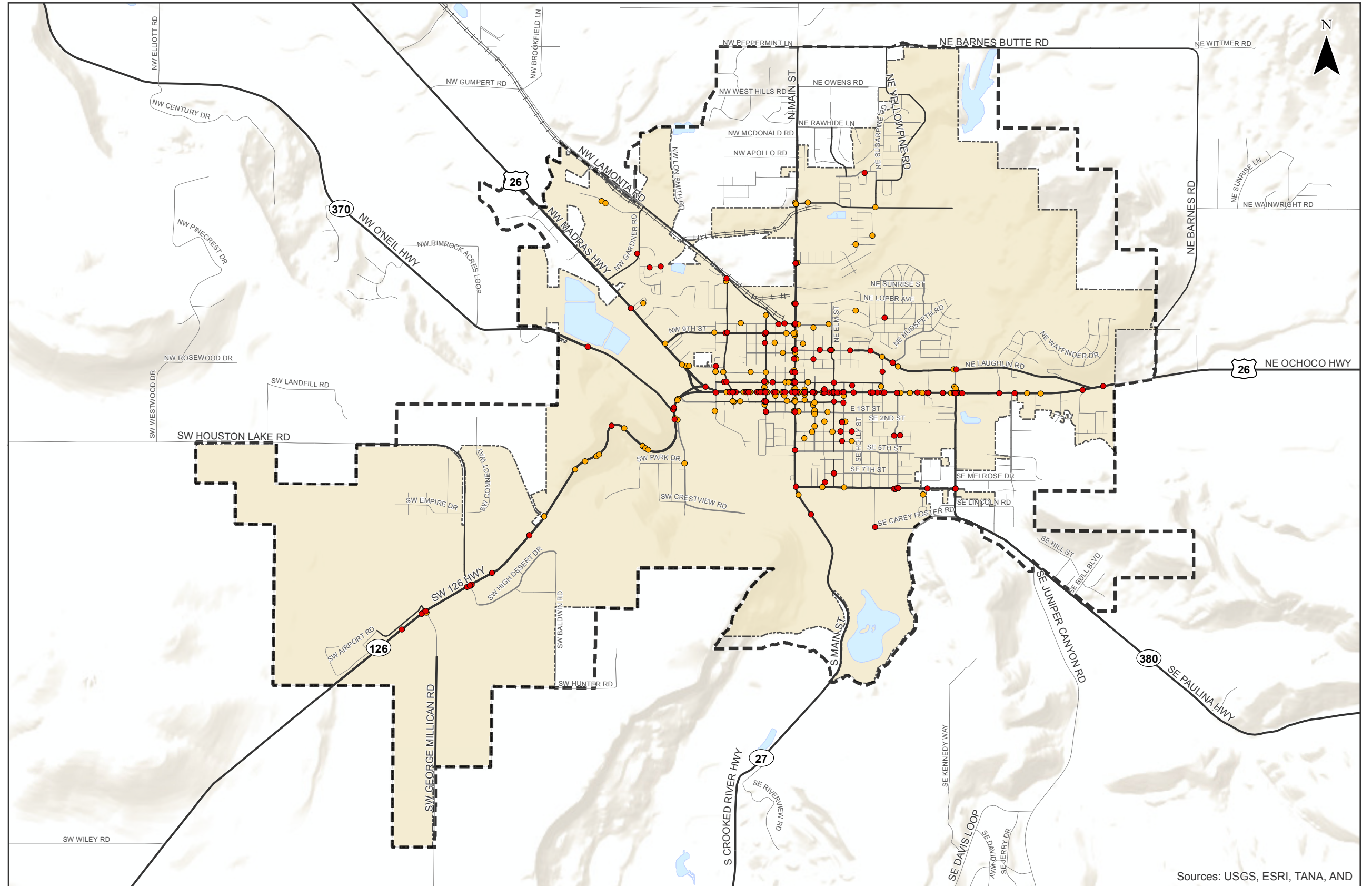

Sources: USGS, ESRI, TANA, AND

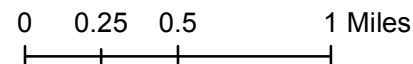

**Reported Crash Locations by Severity (2007-2011)
City of Prineville, Oregon**

**Figure
4-3**

Based on information provided by ODOT, the following segments were identified in the top 5 or 10 percent of SPIS sites.

- A segment of US 26 (N 3rd Street) from Maple to Claypool (Milepost 18.43 to 18.61) was identified in the 2012 top 5-percent of all ODOT sites based on 2009 to 2011 crash data.
- A segment from Deer Street to Claypool (Milepost 18.53 to 18.64) was in the 2009 top 10-percent of all ODOT SPIS sites.
- A segment of US 26 at Harwood and a segment of US 26 at Combs Flat Road (Milepost 19.67 to 19.76) were identified in the top 10-percent of 2011 SPIS sites, based on 2008 to 2010 crash reports.

As part of developing the implementation plan for the TSP, the roadway segments and intersections identified with crash rates higher than the critical crash rate, statewide 90th percentile, and those in the top 5 or 10 percent of the ODOT Safety Priority Index System² will be reviewed in greater detail to identify opportunities to reduce crash frequency.

ACCESS MANAGEMENT

Driveway access onto roadways creates turbulence that reduces throughput and introduces conflict points (for motorized and non-motorized travelers). Expressway facilities, such as OR 126 near the airport, are designated for high-speed intercity travel. Within the downtown core ODOT has designated N 3rd Street (US 26) as a Special Transportation Area, with an emphasis on balancing the needs of local businesses and through travel.

The purpose of access standards and management is to preserve the roadway for its intended function. Poor access management results in frequent conflicts and makes travel for bicyclists and pedestrians difficult. The stopping or decelerating maneuvers of turning vehicles impacts following vehicles, and creates conflicts. Additionally, numerous access points impact businesses, taking up commercially zoned land for circulation rather than building space, parking, or landscaping.

Existing access management standards defined in the revised Oregon Administrative Rule 734 and by the City were applied to existing corridors and segments adjacent to study intersections. These current standards are summarized in *Appendix F*.

² The Safety Priority Index System (SPIS) is a method developed by ODOT for ranking locations annually on state highways by considering crash frequency, crash rate, and crash severity. ODOT's annual SPIS analysis uses the most-recent three years of crash data (i.e., 2012 SPIS sites are based on 2009 through 2011 crash data).

A roadway segment is designated as a SPIS site if a location experiences three or more crashes or one or more fatal crashes over a three-year period. Under this method, all state highways are analyzed in 0.10 mile segments to identify SPIS sites. Statewide, there are approximately 6,000 SPIS sites.

SUMMARY OF FINDINGS

Analysis of the motorized and active transportation systems indicated the following:

- All 22 intersections analyzed meet City and ODOT performance measures, with the exception of the OR 126/Tom McCall Road intersection. Three other intersections meet applicable standards, but operate with higher levels of delay than other intersections in the city.
- The N 3rd Street/Main Street intersection is the only intersection identified to have 95th percentile queues that exceed available storage capacity on one or more approaches. The remaining study intersections have adequate storage, though long queues were noted at several signalized intersections along N 3rd Street.
- Key gaps in the existing bicycle and pedestrian system were identified through a review of the Safe Routes to School (SRTS) Action Plans prepared by the City and its residents for three schools in Prineville and an assessment of the location of existing sidewalks and bicycle routes relative to popular/desired pedestrian and bicycle destinations (e.g., downtown, hospital, city parks, etc.).
- Nine pedestrian-involved crashes and eight bicyclist-involved crashes were reported over the 5-year period and all resulted in injuries. The locations of the crashes vary throughout the UGB.
- The Deer Street/2nd Street, N 4th Street/Main Street, and the Main Street/N 9th Street intersections have crash rates that exceed the critical crash rate and the statewide 90th percentile rate for similar intersections.

REFERENCES

1. The Oregon Department of Transportation. *Analysis Procedures Manual*. 2006.
2. Transportation Research Board. *Highway Capacity Manual*. 2000.

APPENDICES

Appendix A – Traffic Count Data

Appendix B – Analysis Methodology

Appendix C – Existing Conditions Traffic Operations and Queuing Analysis Worksheets

Appendix D – Active Transportation Maps

Appendix E – Crash Analysis Information

Appendix F – Access Management Standards

APPENDIX A – TRAFFIC COUNT DATA

LOCATION: Lamonta Rd -- Harwood St
CITY/STATE: Prineville, OR

QC JOB #: 10736501
DATE: Tue, Apr 10 2012

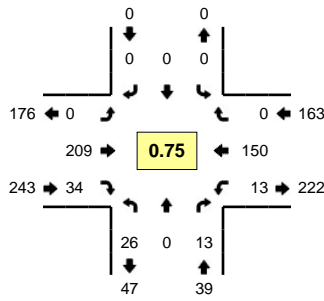

Peak-Hour: 4:00 PM -- 5:00 PM
Peak 15-Min: 4:00 PM -- 4:15 PM

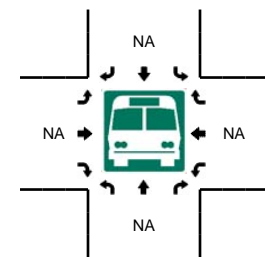
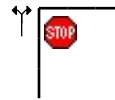
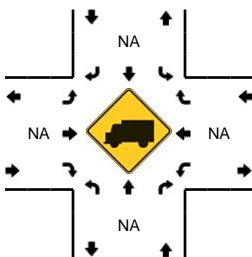
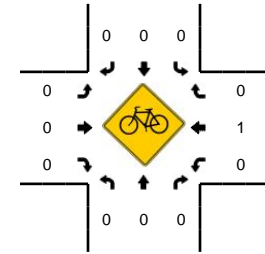
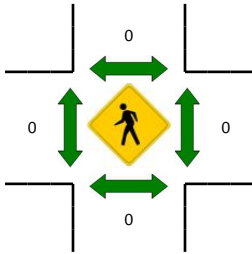
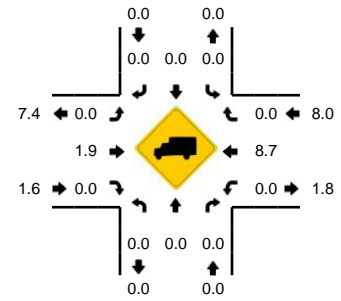

5-Min Count Period Beginning At	Lamonta Rd (Northbound)				Lamonta Rd (Southbound)				Harwood St (Eastbound)				Harwood St (Westbound)				Total	Hourly Totals
	Left	Thru	Right	U	Left	Thru	Right	U	Left	Thru	Right	U	Left	Thru	Right	U		
4:00 PM	4	0	0	0	0	0	0	0	0	30	7	0	3	10	0	0	54	
4:05 PM	0	0	4	0	0	0	0	0	0	26	7	0	1	15	0	0	53	
4:10 PM	3	0	1	0	0	0	0	0	0	12	5	0	1	19	0	0	41	
4:15 PM	2	0	2	0	0	0	0	0	0	16	1	0	0	19	0	0	40	
4:20 PM	1	0	0	0	0	0	0	0	0	16	3	0	2	13	0	0	35	
4:25 PM	3	0	0	0	0	0	0	0	0	20	2	0	1	12	0	0	38	
4:30 PM	3	0	1	0	0	0	0	0	0	20	1	0	0	15	0	0	40	
4:35 PM	4	0	1	0	0	0	0	0	0	15	1	0	1	16	0	0	38	
4:40 PM	4	0	1	0	0	0	0	0	0	14	3	0	0	12	0	0	34	
4:45 PM	2	0	0	0	0	0	0	0	0	12	1	0	2	4	0	0	21	
4:50 PM	0	0	3	0	0	0	0	0	0	19	0	0	1	9	0	0	32	
4:55 PM	0	0	0	0	0	0	0	0	0	9	3	0	1	6	0	0	19	445
5:00 PM	2	0	0	0	0	0	0	0	0	17	1	0	3	9	0	0	32	423
5:05 PM	0	0	0	0	0	0	0	0	0	22	4	0	3	6	0	0	35	405
5:10 PM	3	0	0	0	0	0	0	0	0	10	0	0	3	9	0	0	25	389
5:15 PM	5	0	3	0	0	0	0	0	0	8	3	0	1	6	0	0	26	375
5:20 PM	2	0	1	0	0	0	0	0	0	9	2	0	1	17	0	0	32	372
5:25 PM	1	0	4	0	0	0	0	0	0	3	1	0	4	13	0	0	26	360
5:30 PM	2	0	4	0	0	0	0	0	0	9	0	0	1	10	0	0	26	346
5:35 PM	2	0	1	0	0	0	0	0	0	9	1	0	0	7	0	0	20	328
5:40 PM	5	0	0	0	0	0	0	0	0	12	0	0	0	7	0	0	24	318
5:45 PM	1	0	0	0	0	0	0	0	0	13	0	0	0	7	0	0	21	318
5:50 PM	1	0	1	0	0	0	0	0	0	15	2	0	0	7	0	0	26	312
5:55 PM	0	0	3	0	0	0	0	0	0	7	1	0	0	9	0	0	20	313
Peak 15-Min Flowrates	Northbound				Southbound				Eastbound				Westbound				Total	
All Vehicles	28	0	20	0	0	0	0	0	0	272	76	0	20	176	0	0	592	
Heavy Trucks	0	0	0	0	0	0	0	0	0	0	0	0	0	16	0	0	16	
Pedestrians	0	0	0	0	0	0	0	0	0	0	0	0	0	0	0	0	0	
Bicycles	0	0	0	0	0	0	0	0	0	0	0	0	0	0	0	0	0	
Railroad																		
Stopped Buses																		

Comments:

LOCATION: Main St -- 7th St
CITY/STATE: Prineville, OR

QC JOB #: 10736502
DATE: Tue, Apr 10 2012

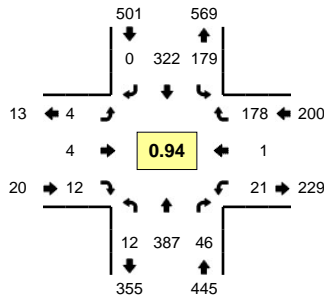

Peak-Hour: 4:20 PM -- 5:20 PM
Peak 15-Min: 4:55 PM -- 5:10 PM

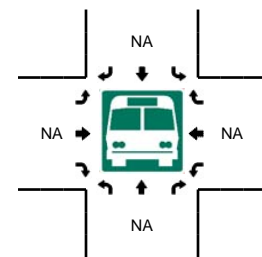
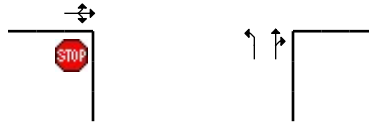
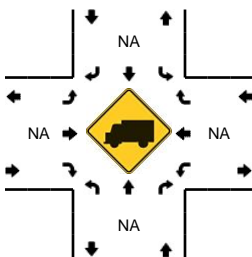
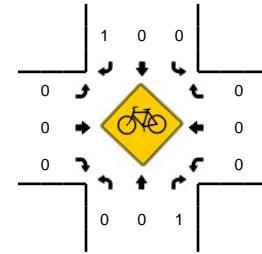
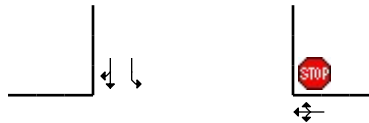
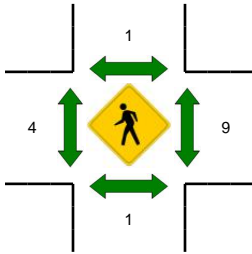
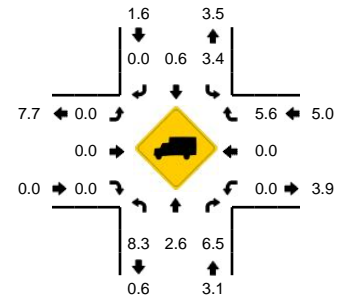

5-Min Count Period Beginning At	Main St (Northbound)				Main St (Southbound)				7th St (Eastbound)				7th St (Westbound)				Total	Hourly Totals
	Left	Thru	Right	U	Left	Thru	Right	U	Left	Thru	Right	U	Left	Thru	Right	U		
4:00 PM	0	33	3	0	12	34	0	0	0	0	0	0	5	1	14	0	102	
4:05 PM	2	24	5	0	19	32	0	0	0	0	0	0	3	0	14	0	99	
4:10 PM	1	34	6	0	12	28	0	0	0	0	1	0	2	0	14	0	98	
4:15 PM	0	26	3	0	14	24	0	0	0	0	1	0	3	0	12	0	83	
4:20 PM	1	35	3	0	12	26	0	0	0	0	1	0	0	0	13	0	91	
4:25 PM	1	31	4	0	17	25	0	0	1	0	0	0	4	0	21	0	104	
4:30 PM	2	28	5	0	16	25	0	0	0	0	1	0	1	1	12	0	91	
4:35 PM	0	35	2	0	19	29	0	0	0	0	1	0	2	0	18	0	106	
4:40 PM	0	37	3	0	16	28	0	0	0	1	2	0	1	0	15	0	103	
4:45 PM	1	29	2	0	15	30	0	0	0	0	1	0	4	0	9	0	91	
4:50 PM	0	27	1	0	18	28	0	0	1	1	0	0	2	0	9	0	87	
4:55 PM	0	30	6	0	10	31	0	0	1	2	0	0	2	0	10	0	92	1147
5:00 PM	0	31	5	0	13	32	0	0	0	0	2	0	4	0	16	0	103	1148
5:05 PM	4	45	7	0	16	26	0	0	1	0	1	0	0	0	14	0	114	1163
5:10 PM	0	28	6	0	15	23	0	0	0	0	3	0	1	0	16	0	92	1157
5:15 PM	3	31	2	0	12	19	0	0	0	0	0	0	0	0	25	0	92	1166
5:20 PM	1	37	1	0	7	19	0	0	0	1	1	0	2	0	15	0	84	1159
5:25 PM	0	26	2	0	13	14	0	0	0	1	0	0	3	1	11	0	71	1126
5:30 PM	1	27	3	0	7	22	0	0	0	0	1	0	2	2	14	0	79	1114
5:35 PM	1	35	4	0	13	30	0	0	1	2	0	0	0	0	15	0	101	1109
5:40 PM	1	43	5	0	10	30	0	0	0	0	1	0	4	0	12	0	106	1112
5:45 PM	1	33	3	0	9	16	1	0	0	0	1	0	2	0	10	0	76	1097
5:50 PM	1	42	3	0	11	28	0	0	0	0	0	0	1	0	17	0	103	1113
5:55 PM	1	28	1	0	8	23	0	0	0	1	0	0	1	0	10	0	73	1094
Peak 15-Min Flowrates	Northbound				Southbound				Eastbound				Westbound				Total	
	Left	Thru	Right	U	Left	Thru	Right	U	Left	Thru	Right	U	Left	Thru	Right	U		
All Vehicles	16	424	72	0	156	356	0	0	8	8	12	0	24	0	160	0	1236	
Heavy Trucks	4	8	12		4	0	0		0	0	0		0	0	8		36	
Pedestrians		4				0				0				0			4	
Bicycles	0	0	0		0	0	0		0	0	0		0	0	0		0	
Railroad																		
Stopped Buses																		

Comments:

LOCATION: Deer St -- US 26
CITY/STATE: Prineville, OR

QC JOB #: 10736503
DATE: Tue, Apr 10 2012

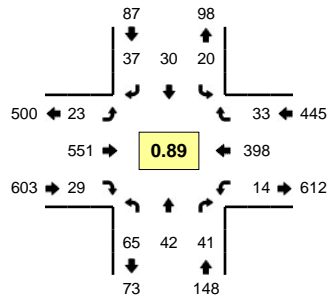

Peak-Hour: 4:15 PM -- 5:15 PM
Peak 15-Min: 5:00 PM -- 5:15 PM

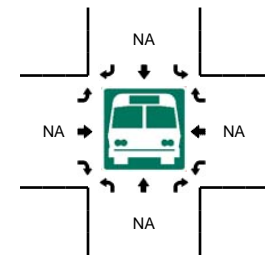
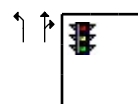
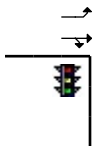
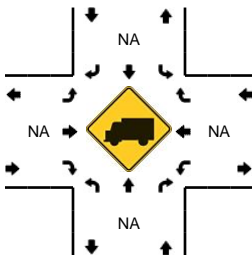
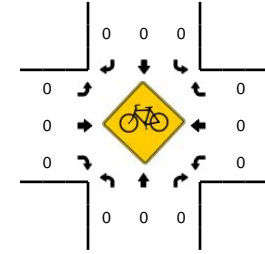
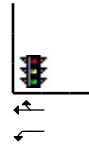
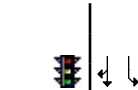
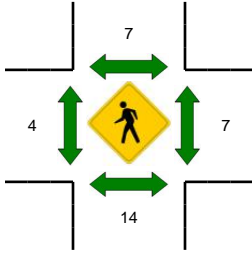
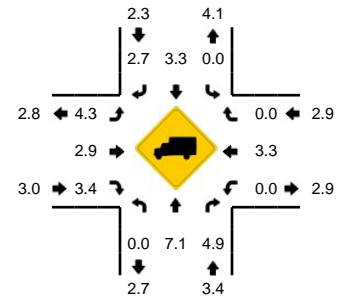

5-Min Count Period Beginning At	Deer St (Northbound)				Deer St (Southbound)				US 26 (Eastbound)				US 26 (Westbound)				Total	Hourly Totals
	Left	Thru	Right	U	Left	Thru	Right	U	Left	Thru	Right	U	Left	Thru	Right	U		
4:00 PM	4	5	3	0	2	2	5	0	0	47	4	0	0	43	1	0	116	
4:05 PM	6	5	6	0	5	5	8	0	4	36	5	0	1	44	2	0	127	
4:10 PM	12	3	2	0	0	6	3	0	2	32	4	0	1	24	1	0	90	
4:15 PM	6	3	7	0	2	1	2	0	3	42	3	0	0	37	3	0	109	
4:20 PM	6	4	2	0	1	3	5	0	3	32	1	0	1	35	2	0	95	
4:25 PM	7	0	1	0	3	1	4	0	4	39	0	0	1	41	3	0	104	
4:30 PM	4	1	3	0	2	4	4	0	2	59	8	0	0	26	3	0	116	
4:35 PM	5	4	1	0	3	4	4	0	1	47	2	0	2	31	3	0	107	
4:40 PM	2	7	3	0	2	1	1	0	2	48	3	0	1	30	5	0	105	
4:45 PM	3	3	6	0	0	1	2	0	3	49	1	0	2	18	2	0	90	
4:50 PM	5	0	6	0	0	3	2	0	2	41	1	0	1	47	1	0	109	
4:55 PM	6	6	2	0	2	4	3	0	0	42	0	0	0	19	2	0	86	1254
5:00 PM	3	5	7	0	1	4	4	0	0	43	5	0	2	39	2	0	115	1253
5:05 PM	5	6	0	0	2	4	4	0	2	53	1	0	2	30	4	0	113	1239
5:10 PM	13	3	3	0	2	0	2	0	1	56	4	0	2	45	3	0	134	1283
5:15 PM	5	5	3	0	2	2	5	0	2	37	3	0	0	32	1	0	97	1271
5:20 PM	9	3	5	0	0	3	4	0	3	45	1	0	1	29	1	0	104	1280
5:25 PM	2	4	3	0	2	1	4	0	2	52	0	0	0	23	1	0	94	1270
5:30 PM	7	2	3	0	1	2	2	0	1	48	3	0	3	35	0	0	107	1261
5:35 PM	8	4	2	0	4	2	2	0	3	48	8	0	0	36	1	0	118	1272
5:40 PM	2	1	2	0	4	5	1	0	3	52	2	0	1	31	3	0	107	1274
5:45 PM	2	1	3	0	1	2	3	0	2	44	5	0	0	22	1	0	86	1270
5:50 PM	2	1	2	0	1	2	9	0	1	48	1	0	1	37	1	0	106	1267
5:55 PM	6	3	4	0	2	1	2	0	1	39	1	0	0	24	2	0	85	1266
Peak 15-Min Flowrates	Northbound				Southbound				Eastbound				Westbound				Total	
All Vehicles	84	56	40	0	20	32	40	0	12	608	40	0	24	456	36	0	1448	
Heavy Trucks	0	4	0	0	0	0	0	0	0	12	4	0	0	8	0	0	28	
Pedestrians		8				4				0				4			16	
Bicycles	0	0	0		0	0	0		0	0	0		0	0	0		0	
Railroad																		
Stopped Buses																		

Comments:

LOCATION: Main St -- US 26
CITY/STATE: Prineville, OR

QC JOB #: 10736504
DATE: Tue, Apr 10 2012

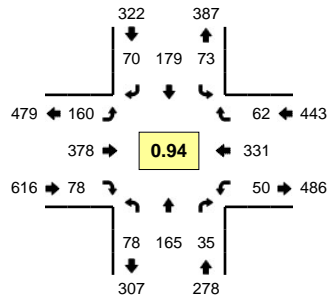

Peak-Hour: 4:00 PM -- 5:00 PM
Peak 15-Min: 4:30 PM -- 4:45 PM

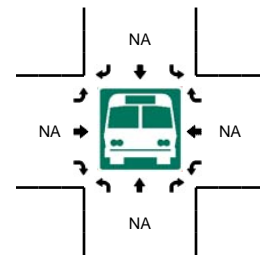
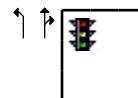
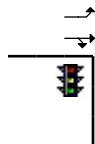
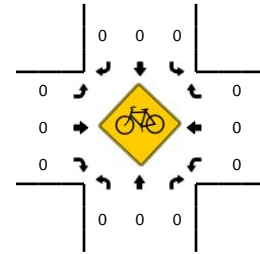
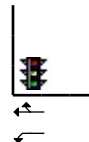
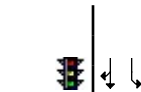
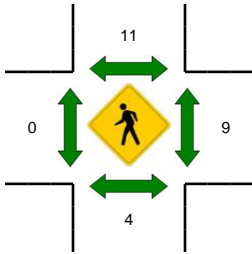
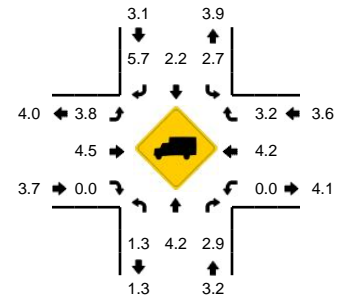

5-Min Count Period Beginning At	Main St (Northbound)				Main St (Southbound)				US 26 (Eastbound)				US 26 (Westbound)				Total	Hourly Totals
	Left	Thru	Right	U	Left	Thru	Right	U	Left	Thru	Right	U	Left	Thru	Right	U		
4:00 PM	9	13	2	0	3	22	6	0	16	25	8	0	2	29	4	0	139	
4:05 PM	8	11	2	0	5	21	5	0	16	31	7	0	4	32	5	0	147	
4:10 PM	7	19	5	0	3	17	6	0	11	29	9	0	3	27	6	0	142	
4:15 PM	9	16	1	0	8	17	5	0	6	34	4	0	4	32	4	0	140	
4:20 PM	4	12	4	0	12	9	7	0	15	25	7	0	7	36	1	0	139	
4:25 PM	7	13	4	0	9	14	5	0	9	24	6	0	3	34	7	0	135	
4:30 PM	7	14	2	0	6	14	5	0	16	40	4	0	5	18	9	0	140	
4:35 PM	5	7	4	0	5	13	9	0	11	37	5	0	6	28	6	0	136	
4:40 PM	5	20	3	0	3	18	8	0	11	49	10	0	2	31	4	0	164	
4:45 PM	2	17	2	0	6	10	5	0	16	27	6	0	5	15	3	0	114	
4:50 PM	11	11	3	0	7	14	5	0	12	25	8	0	6	27	7	0	136	
4:55 PM	4	12	3	0	6	10	4	0	21	32	4	0	3	22	6	0	127	1659
5:00 PM	4	11	1	0	9	17	6	0	9	28	7	0	4	31	7	0	134	1654
5:05 PM	9	19	3	0	7	20	5	0	8	23	9	0	6	27	8	0	144	1651
5:10 PM	8	9	2	0	10	14	4	0	12	43	2	0	7	28	5	0	144	1653
5:15 PM	6	17	1	0	4	15	6	0	7	35	3	0	5	24	7	0	130	1643
5:20 PM	7	19	5	0	11	11	4	0	11	32	4	0	6	19	8	0	137	1641
5:25 PM	3	8	3	0	2	10	2	0	10	44	4	0	2	14	5	0	107	1613
5:30 PM	6	10	2	0	3	9	3	0	8	34	3	0	6	23	4	0	111	1584
5:35 PM	9	15	3	0	7	13	5	0	14	27	10	0	4	26	2	0	135	1583
5:40 PM	3	15	1	0	9	15	10	0	26	33	10	0	5	24	4	0	155	1574
5:45 PM	4	8	4	0	5	12	2	0	18	25	7	0	4	31	7	0	127	1587
5:50 PM	3	15	2	0	7	14	4	0	18	24	6	0	3	23	5	0	124	1575
5:55 PM	3	18	1	0	0	17	3	0	8	26	10	0	3	22	5	0	116	1564
Peak 15-Min Flowrates	Northbound				Southbound				Eastbound				Westbound				Total	
All Vehicles	68	164	36	0	56	180	88	0	152	504	76	0	52	308	76	0	1760	
Heavy Trucks	0	0	0	0	0	0	0	0	8	16	0	0	0	8	4	0	36	
Pedestrians					12				0				4				16	
Bicycles	0	0	0	0	0	0	0	0	0	0	0	0	0	0	0	0	0	
Railroad																		
Stopped Buses																		

Comments:

LOCATION: Laughlin Rd -- US 26
CITY/STATE: Prineville, OR

QC JOB #: 10736505
DATE: Wed, Apr 11 2012

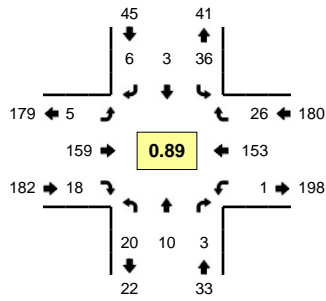

Peak-Hour: 4:00 PM -- 5:00 PM
Peak 15-Min: 4:40 PM -- 4:55 PM

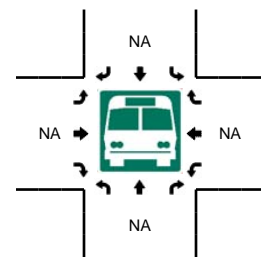
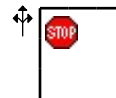
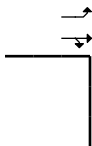
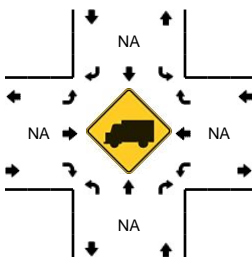
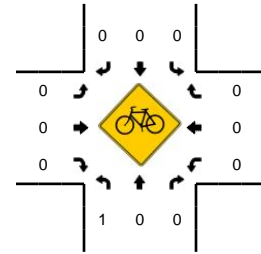
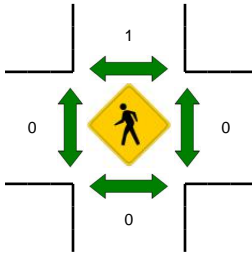
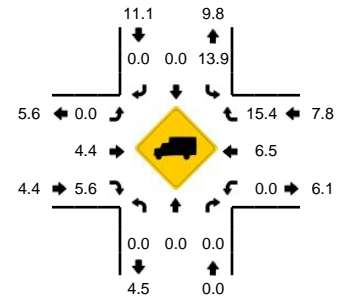

5-Min Count Period Beginning At	Laughlin Rd (Northbound)				Laughlin Rd (Southbound)				US 26 (Eastbound)				US 26 (Westbound)				Total	Hourly Totals	
	Left	Thru	Right	U	Left	Thru	Right	U	Left	Thru	Right	U	Left	Thru	Right	U			
4:00 PM	3	0	1	0	2	0	0	0	2	17	1	0	0	15	1	0	0	42	
4:05 PM	1	2	1	0	5	0	2	0	0	7	2	0	0	13	2	0	0	35	
4:10 PM	2	0	0	0	3	0	0	0	0	13	3	0	0	13	2	0	0	36	
4:15 PM	0	1	0	0	4	0	0	0	0	14	0	0	0	11	4	0	0	34	
4:20 PM	0	1	0	0	2	0	2	0	1	13	0	0	0	17	2	0	0	38	
4:25 PM	1	0	0	0	0	1	0	0	0	14	4	0	1	18	4	0	0	43	
4:30 PM	4	2	1	0	3	0	0	0	1	15	1	0	0	7	2	0	0	36	
4:35 PM	3	3	0	0	2	0	0	0	1	6	0	0	0	9	0	0	0	24	
4:40 PM	0	0	0	0	5	0	1	0	0	16	0	0	0	10	6	0	0	38	
4:45 PM	3	0	0	0	4	1	0	0	0	12	4	0	0	18	0	0	0	42	
4:50 PM	1	1	0	0	4	0	0	0	0	16	2	0	0	18	1	0	0	43	
4:55 PM	2	0	0	0	2	1	1	0	0	16	1	0	0	4	2	0	0	29	440
5:00 PM	3	2	0	0	1	1	0	0	0	11	4	0	0	10	2	0	0	34	432
5:05 PM	2	1	0	0	3	0	2	0	0	13	0	0	0	9	1	0	0	31	428
5:10 PM	1	0	0	0	3	0	1	0	0	16	0	0	0	2	0	0	0	23	415
5:15 PM	3	1	0	0	1	0	0	0	0	18	1	0	1	13	2	0	0	40	421
5:20 PM	2	0	0	0	4	0	0	0	0	21	1	0	0	11	1	0	0	40	423
5:25 PM	1	1	0	0	4	0	1	0	0	16	0	0	0	18	0	0	0	41	421
5:30 PM	1	0	1	0	5	0	1	0	0	11	0	0	0	16	2	0	0	37	422
5:35 PM	6	1	0	0	4	1	2	0	0	14	1	0	1	6	1	0	0	37	435
5:40 PM	2	0	0	0	3	0	0	0	0	14	1	0	0	14	2	0	0	36	433
5:45 PM	1	1	0	0	5	0	0	0	0	15	1	0	0	10	2	0	0	35	426
5:50 PM	2	0	0	0	3	0	0	0	0	20	0	0	0	4	3	0	0	32	415
5:55 PM	0	0	0	0	6	0	0	0	0	10	1	0	0	5	2	0	0	24	410
Peak 15-Min Flowrates	Northbound				Southbound				Eastbound				Westbound				Total		
All Vehicles	16	4	0	0	52	4	4	0	0	176	24	0	0	184	28	0	492		
Heavy Trucks	0	0	0	0	8	0	0	0	0	8	4	0	0	20	0	0	40		
Pedestrians	0	0	0	0	0	0	0	0	0	0	0	0	0	0	0	0	0		
Bicycles	0	0	0	0	0	0	0	0	0	0	0	0	0	0	0	0	0		
Railroad																			
Stopped Buses																			

Comments:

LOCATION: Main St -- 9th St
CITY/STATE: Prineville, OR

QC JOB #: 10736506
DATE: Tue, Apr 10 2012

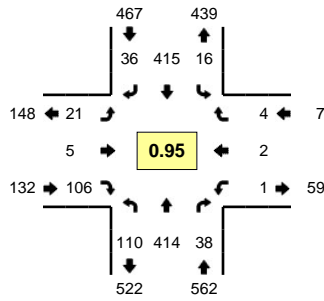

Peak-Hour: 4:25 PM -- 5:25 PM
Peak 15-Min: 4:30 PM -- 4:45 PM

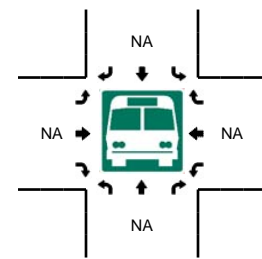
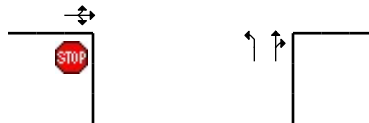
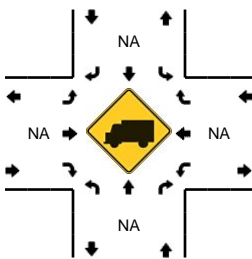
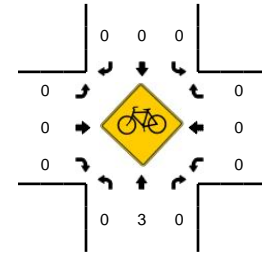
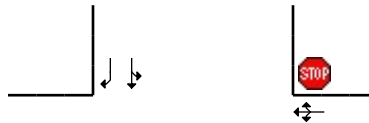
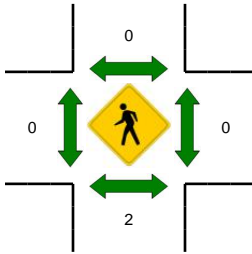
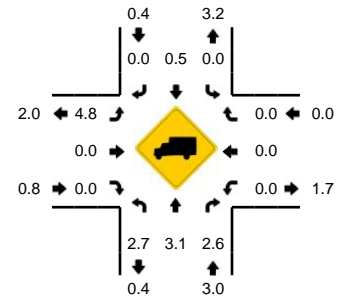

5-Min Count Period Beginning At	Main St (Northbound)				Main St (Southbound)				9th St (Eastbound)				9th St (Westbound)				Total	Hourly Totals
	Left	Thru	Right	U	Left	Thru	Right	U	Left	Thru	Right	U	Left	Thru	Right	U		
4:00 PM	10	26	0	0	2	41	3	0	2	1	7	0	0	0	1	0	93	
4:05 PM	4	32	5	0	1	43	1	0	0	2	9	0	0	0	1	0	98	
4:10 PM	9	34	2	0	3	41	1	0	0	0	8	0	0	0	0	0	98	
4:15 PM	8	28	3	0	2	30	8	0	1	1	6	0	0	0	0	0	87	
4:20 PM	9	33	2	0	1	34	0	0	1	0	9	0	0	0	0	0	89	
4:25 PM	12	37	1	0	1	33	1	0	0	1	12	0	0	0	0	0	98	
4:30 PM	8	32	4	0	0	36	4	0	4	2	9	0	0	0	0	0	99	
4:35 PM	11	36	5	0	1	35	4	0	0	0	9	0	0	0	0	0	101	
4:40 PM	9	39	3	0	1	42	1	0	2	0	10	0	1	0	0	0	108	
4:45 PM	6	30	2	0	0	41	3	0	1	0	11	0	0	0	1	0	95	
4:50 PM	5	28	3	0	2	43	3	0	3	0	6	0	0	0	1	0	94	
4:55 PM	4	31	4	0	4	34	6	0	0	0	6	0	0	1	0	0	90	1150
5:00 PM	8	33	5	0	3	37	2	0	1	0	10	0	0	0	0	0	99	1156
5:05 PM	12	38	4	0	0	35	2	0	5	0	12	0	0	0	0	0	108	1166
5:10 PM	15	29	3	0	1	29	2	0	2	2	9	0	0	0	0	0	92	1160
5:15 PM	11	37	4	0	1	24	4	0	1	0	8	0	0	0	0	0	90	1163
5:20 PM	9	44	0	0	2	26	4	0	2	0	4	0	0	1	2	0	94	1168
5:25 PM	9	25	4	0	1	18	2	0	3	3	5	0	0	0	0	0	70	1140
5:30 PM	5	26	8	0	3	23	4	0	2	0	9	0	0	0	0	0	80	1121
5:35 PM	5	41	2	0	1	31	2	0	3	0	7	0	0	0	2	0	94	1114
5:40 PM	9	43	5	0	3	27	4	0	3	2	10	0	0	0	0	0	106	1112
5:45 PM	7	28	4	0	1	20	3	0	2	0	3	0	0	0	0	0	68	1085
5:50 PM	15	45	0	0	1	28	3	0	7	0	9	0	0	0	0	0	108	1099
5:55 PM	3	29	1	0	1	26	1	0	4	1	6	0	2	1	0	0	75	1084
Peak 15-Min Flowrates	Northbound				Southbound				Eastbound				Westbound				Total	
All Vehicles	112	428	48	0	8	452	36	0	24	8	112	0	4	0	0	0	1232	
Heavy Trucks	0	16	0	0	0	4	0	0	0	0	0	0	0	0	0	0	20	
Pedestrians		4				0				0				0			4	
Bicycles	0	3	0		0	0	0		0	0	0		0	0	0		3	
Railroad																		
Stopped Buses																		

Comments:

LOCATION: Elm St -- US 26
CITY/STATE: Prineville, OR

QC JOB #: 10736507
DATE: Tue, Apr 10 2012

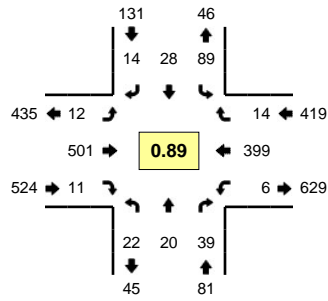

Peak-Hour: 4:30 PM -- 5:30 PM
Peak 15-Min: 5:05 PM -- 5:20 PM

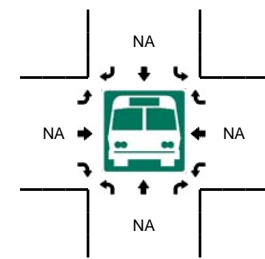
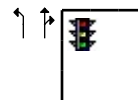
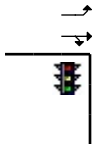
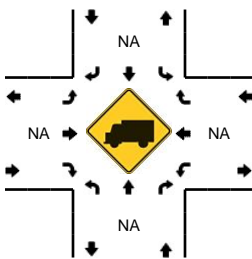
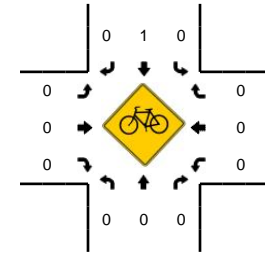
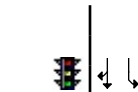
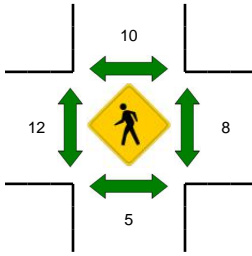
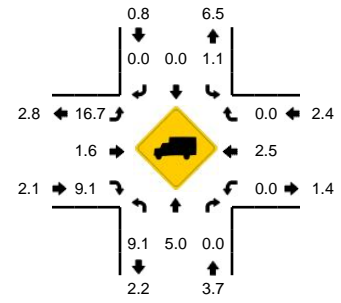

5-Min Count Period Beginning At	Elm St (Northbound)				Elm St (Southbound)				US 26 (Eastbound)				US 26 (Westbound)				Total	Hourly Totals
	Left	Thru	Right	U	Left	Thru	Right	U	Left	Thru	Right	U	Left	Thru	Right	U		
4:00 PM	0	5	2	0	4	3	3	0	1	30	1	0	0	41	0	0	90	
4:05 PM	1	2	3	0	4	3	2	0	5	34	0	0	0	42	5	0	101	
4:10 PM	1	1	3	0	7	3	2	0	3	32	1	0	0	38	2	0	93	
4:15 PM	0	3	2	0	9	1	1	0	2	34	2	0	2	45	3	0	104	
4:20 PM	3	0	2	0	6	2	2	0	0	33	4	0	0	45	1	0	98	
4:25 PM	2	2	3	0	5	3	0	0	3	28	1	0	2	35	2	0	86	
4:30 PM	2	2	4	0	2	0	0	0	0	45	3	0	0	32	1	0	91	
4:35 PM	1	2	4	0	7	2	1	0	0	39	0	0	3	38	0	0	97	
4:40 PM	0	1	2	0	2	1	2	0	2	47	1	0	0	30	3	0	91	
4:45 PM	1	2	5	0	10	3	1	0	0	37	1	0	2	26	2	0	90	
4:50 PM	2	0	1	0	10	2	0	0	1	43	0	0	1	34	1	0	95	
4:55 PM	3	0	1	0	8	2	1	0	2	29	1	0	0	29	2	0	78	1114
5:00 PM	2	2	3	0	7	2	1	0	4	38	1	0	0	41	1	0	102	1126
5:05 PM	4	2	4	0	10	6	3	0	2	38	1	0	0	37	0	0	107	1132
5:10 PM	3	3	5	0	10	0	1	0	0	53	1	0	0	36	1	0	113	1152
5:15 PM	2	0	7	0	5	4	2	0	0	47	1	0	0	36	1	0	105	1153
5:20 PM	2	3	2	0	10	3	0	0	0	39	1	0	0	30	1	0	91	1146
5:25 PM	0	3	1	0	8	3	2	0	1	46	0	0	0	30	1	0	95	1155
5:30 PM	1	1	2	0	2	0	1	0	2	42	1	0	1	35	3	0	91	1155
5:35 PM	0	2	1	0	2	0	4	0	1	42	0	0	1	37	2	0	92	1150
5:40 PM	0	5	1	0	4	2	1	0	1	38	0	0	2	34	0	0	88	1147
5:45 PM	1	1	0	0	5	4	0	0	0	29	0	0	0	41	2	0	83	1140
5:50 PM	0	1	0	0	3	2	2	0	1	40	0	0	1	28	0	0	78	1123
5:55 PM	2	3	1	0	4	3	0	0	1	26	1	0	1	26	4	0	72	1117
Peak 15-Min Flowrates	Northbound				Southbound				Eastbound				Westbound				Total	
All Vehicles	36	20	64	0	100	40	24	0	8	552	12	0	0	436	8	0	1300	
Heavy Trucks	4	0	0		4	0	0		0	8	0		0	0	0		16	
Pedestrians					12				20				12				44	
Bicycles	0	0	0		0	0	0		0	0	0		0	0	0		0	
Railroad																	0	
Stopped Buses																		

Comments:

LOCATION: Main St -- 4th St N
CITY/STATE: Prineville, OR

QC JOB #: 10736508
DATE: Tue, Apr 10 2012

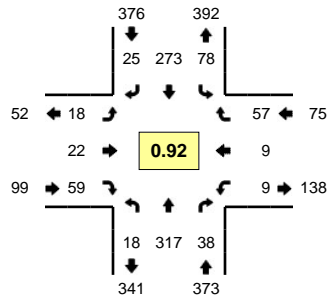

Peak-Hour: 4:10 PM -- 5:10 PM
Peak 15-Min: 4:55 PM -- 5:10 PM

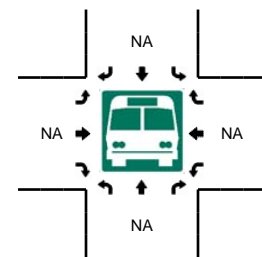
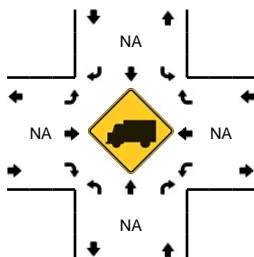
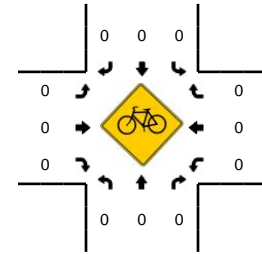
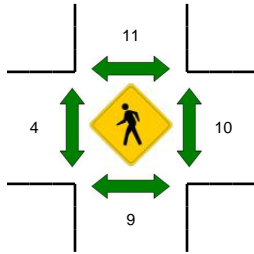
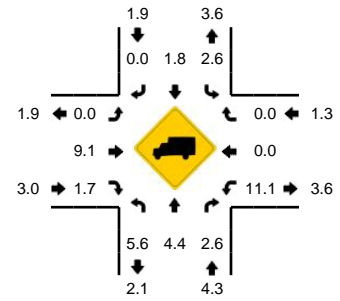

5-Min Count Period Beginning At	Main St (Northbound)				Main St (Southbound)				4th St N (Eastbound)				4th St N (Westbound)				Total	Hourly Totals
	Left	Thru	Right	U	Left	Thru	Right	U	Left	Thru	Right	U	Left	Thru	Right	U		
4:00 PM	3	27	2	0	7	28	5	0	0	0	5	0	0	0	2	0	79	
4:05 PM	2	27	2	0	13	20	2	0	0	3	7	0	0	2	5	0	83	
4:10 PM	2	24	6	0	6	21	1	0	1	4	5	0	1	3	7	0	81	
4:15 PM	2	22	6	0	9	20	0	0	1	1	7	0	1	1	5	0	75	
4:20 PM	3	20	0	0	4	25	2	0	3	2	7	0	0	0	8	0	74	
4:25 PM	0	28	2	0	8	19	1	0	0	0	5	0	0	0	5	0	68	
4:30 PM	3	32	2	0	1	21	2	0	0	1	4	0	1	1	2	0	70	
4:35 PM	0	23	1	0	2	27	1	0	3	3	4	0	1	0	3	0	68	
4:40 PM	2	30	1	0	8	22	3	0	3	5	2	0	0	0	4	0	80	
4:45 PM	2	31	3	0	10	24	2	0	1	1	1	0	1	0	3	0	79	
4:50 PM	2	23	8	0	11	21	1	0	1	1	5	0	1	1	2	0	77	
4:55 PM	1	28	5	0	6	24	5	0	0	3	1	0	1	2	4	0	80	914
5:00 PM	0	25	3	0	10	27	4	0	1	1	6	0	1	0	7	0	85	920
5:05 PM	1	31	1	0	3	22	3	0	4	0	12	0	1	1	7	0	86	923
5:10 PM	1	25	2	0	3	21	1	0	1	3	5	0	0	0	4	0	66	908
5:15 PM	2	22	2	0	4	17	1	0	3	0	6	0	0	1	5	0	63	896
5:20 PM	2	32	4	0	4	16	2	0	1	1	4	0	0	0	2	0	68	890
5:25 PM	1	18	3	0	3	13	2	0	1	0	3	0	0	0	2	0	46	868
5:30 PM	1	23	1	0	3	18	2	0	2	0	0	0	0	1	4	0	55	853
5:35 PM	1	29	5	0	7	23	0	0	2	1	5	0	1	1	6	0	81	866
5:40 PM	2	39	3	0	8	27	1	0	1	0	6	0	0	1	5	0	93	879
5:45 PM	1	29	4	0	4	13	1	0	0	0	3	0	1	0	5	0	61	861
5:50 PM	1	35	1	0	4	22	1	0	2	1	3	0	0	1	5	0	76	860
5:55 PM	1	27	3	0	3	20	1	0	0	1	1	0	1	0	2	0	60	840
Peak 15-Min Flowrates	Northbound				Southbound				Eastbound				Westbound				Total	
	Left	Thru	Right	U	Left	Thru	Right	U	Left	Thru	Right	U	Left	Thru	Right	U		
All Vehicles	8	336	36	0	76	292	48	0	20	16	76	0	12	12	72	0	1004	
Heavy Trucks	4	20	0		0	4	0		0	4	4		0	0	0		36	
Pedestrians		4				4				8				0			16	
Bicycles	0	0	0		0	0	0		0	0	0		0	0	0		0	
Railroad																		
Stopped Buses																		

Comments:

LOCATION: Main St -- 2nd St N
CITY/STATE: Prineville, OR

QC JOB #: 10736509
DATE: Tue, Apr 10 2012

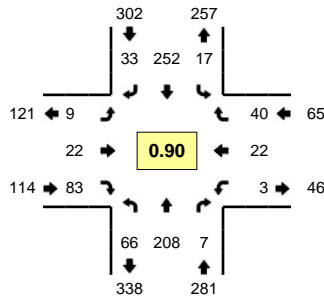

Peak-Hour: 5:00 PM -- 6:00 PM
Peak 15-Min: 5:00 PM -- 5:15 PM

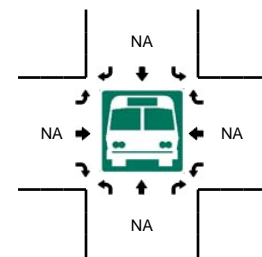
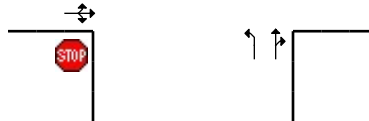
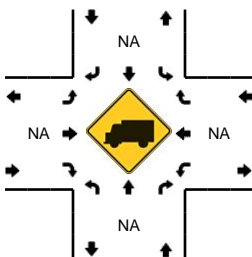
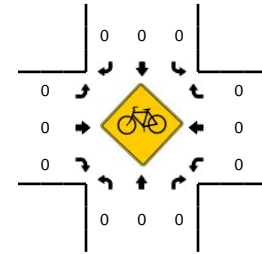
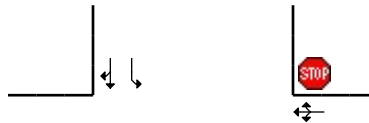
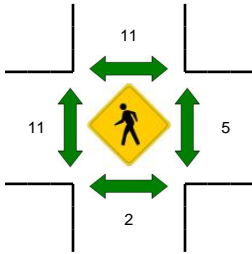
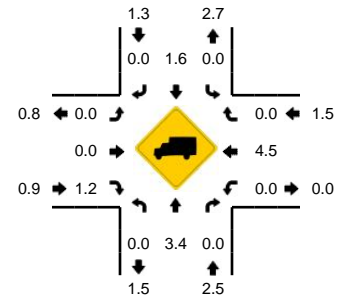

5-Min Count Period Beginning At	Main St (Northbound)				Main St (Southbound)				2nd St N (Eastbound)				2nd St N (Westbound)				Total	Hourly Totals
	Left	Thru	Right	U	Left	Thru	Right	U	Left	Thru	Right	U	Left	Thru	Right	U		
4:00 PM	9	18	2	0	5	19	8	0	1	2	5	0	1	3	4	0	77	
4:05 PM	3	21	1	0	2	22	8	0	0	1	9	0	0	2	4	0	73	
4:10 PM	5	24	1	0	6	17	6	0	0	3	9	0	0	0	3	0	74	
4:15 PM	4	19	2	0	2	19	4	0	2	5	5	0	0	2	4	0	68	
4:20 PM	4	20	0	0	3	19	2	0	1	3	3	0	2	0	3	0	60	
4:25 PM	2	15	2	0	1	16	5	0	0	3	7	0	0	1	5	0	57	
4:30 PM	5	19	0	0	2	14	5	0	0	3	6	0	0	0	3	0	57	
4:35 PM	5	15	1	0	3	20	3	0	2	1	7	0	1	4	1	0	63	
4:40 PM	2	20	0	0	6	18	5	0	0	4	1	0	1	0	3	0	60	
4:45 PM	8	14	2	0	1	16	4	0	1	4	9	0	0	0	6	0	65	
4:50 PM	1	17	0	0	2	20	4	0	2	1	6	0	0	1	4	0	58	
4:55 PM	3	16	0	0	3	11	5	0	1	1	2	0	0	1	1	0	44	756
5:00 PM	3	19	0	0	1	26	2	0	2	1	10	0	1	1	7	0	73	752
5:05 PM	8	17	2	0	1	28	4	0	1	0	2	0	0	4	4	0	71	750
5:10 PM	6	13	1	0	1	21	6	0	1	3	8	0	0	3	4	0	67	743
5:15 PM	6	24	0	0	1	19	1	0	1	3	9	0	1	3	3	0	71	746
5:20 PM	5	24	1	0	1	15	4	0	0	2	8	0	0	1	2	0	63	749
5:25 PM	6	12	0	0	1	17	0	0	1	2	10	0	0	0	2	0	51	743
5:30 PM	6	16	2	0	3	16	4	0	0	2	4	0	0	2	3	0	58	744
5:35 PM	6	21	1	0	0	20	4	0	0	3	4	0	0	4	5	0	68	749
5:40 PM	4	14	0	0	3	26	2	0	1	2	8	0	0	1	5	0	66	755
5:45 PM	6	14	0	0	1	18	2	0	2	2	8	0	1	1	1	0	56	746
5:50 PM	8	15	0	0	2	22	0	0	0	0	6	0	0	2	4	0	59	747
5:55 PM	2	19	0	0	2	24	4	0	0	2	6	0	0	0	0	0	59	762
Peak 15-Min Flowrates	Northbound				Southbound				Eastbound				Westbound				Total	
	Left	Thru	Right	U	Left	Thru	Right	U	Left	Thru	Right	U	Left	Thru	Right	U		
All Vehicles	68	196	12	0	12	300	48	0	16	16	80	0	4	32	60	0	844	
Heavy Trucks	0	8	0	0	0	4	0	0	0	0	4	0	0	0	0	0	16	
Pedestrians		0				4				0				0			4	
Bicycles	0	0	0		0	0	0		0	0	0		0	0	0		0	
Railroad																		
Stopped Buses																		

Comments:

LOCATION: Main St -- 5th St
CITY/STATE: Prineville, OR

QC JOB #: 10736510
DATE: Wed, Apr 11 2012

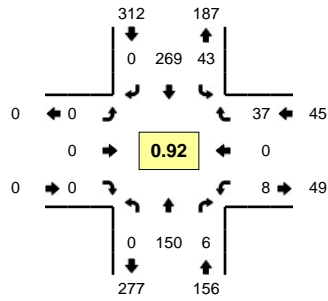

Peak-Hour: 4:45 PM -- 5:45 PM
Peak 15-Min: 4:45 PM -- 5:00 PM

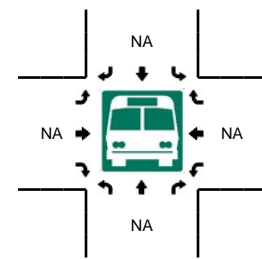
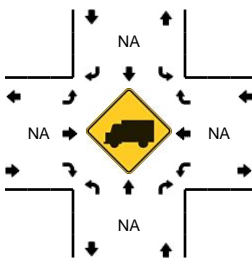
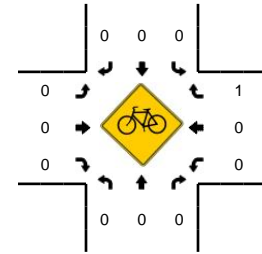
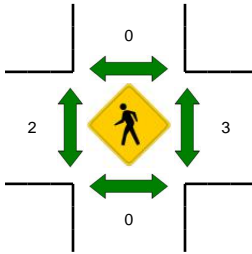
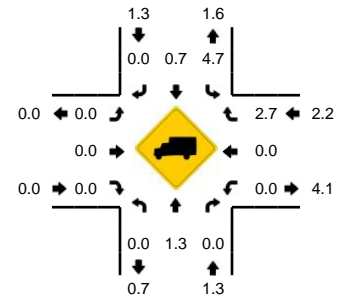

5-Min Count Period Beginning At	Main St (Northbound)				Main St (Southbound)				5th St (Eastbound)				5th St (Westbound)				Total	Hourly Totals
	Left	Thru	Right	U	Left	Thru	Right	U	Left	Thru	Right	U	Left	Thru	Right	U		
4:00 PM	0	13	0	0	4	22	0	0	0	0	0	0	1	0	3	0	43	
4:05 PM	0	18	1	0	5	21	0	0	0	0	0	0	2	0	2	0	49	
4:10 PM	0	15	0	0	7	17	0	0	0	0	0	0	0	0	3	0	42	
4:15 PM	0	13	0	0	1	20	0	0	0	0	0	0	0	0	2	0	36	
4:20 PM	0	10	0	0	1	7	0	0	0	0	0	0	0	0	5	0	23	
4:25 PM	0	13	1	0	0	19	0	0	0	0	0	0	0	0	8	0	41	
4:30 PM	0	9	0	0	3	17	0	0	0	0	0	0	0	0	2	0	31	
4:35 PM	0	8	0	0	7	24	0	0	0	0	0	0	0	0	3	0	42	
4:40 PM	0	9	0	0	4	17	0	0	0	0	0	0	0	0	0	0	30	
4:45 PM	0	16	1	0	4	26	0	0	0	0	0	0	0	0	3	0	50	
4:50 PM	0	18	0	0	1	20	0	0	0	0	0	0	0	0	3	0	42	
4:55 PM	0	12	1	0	6	23	0	0	0	0	0	0	0	0	5	0	47	476
5:00 PM	0	12	0	0	1	21	0	0	0	0	0	0	1	0	3	0	38	471
5:05 PM	0	10	0	0	7	27	0	0	0	0	0	0	0	0	2	0	46	468
5:10 PM	0	9	1	0	7	27	0	0	0	0	0	0	3	0	4	0	51	477
5:15 PM	0	14	0	0	4	18	0	0	0	0	0	0	1	0	3	0	40	481
5:20 PM	0	13	2	0	1	19	0	0	0	0	0	0	1	0	2	0	38	496
5:25 PM	0	5	0	0	4	17	0	0	0	0	0	0	1	0	2	0	29	484
5:30 PM	0	11	0	0	2	26	0	0	0	0	0	0	0	0	5	0	44	497
5:35 PM	0	21	0	0	2	14	0	0	0	0	0	0	1	0	4	0	42	497
5:40 PM	0	9	1	0	4	31	0	0	0	0	0	0	0	0	1	0	46	513
5:45 PM	0	13	0	0	6	17	0	0	0	0	0	0	0	0	7	0	43	506
5:50 PM	0	23	0	0	6	10	0	0	0	0	0	0	0	0	5	0	44	508
5:55 PM	0	13	1	0	8	15	0	0	0	0	0	0	1	0	2	0	40	501
Peak 15-Min Flowrates	Northbound				Southbound				Eastbound				Westbound				Total	
All Vehicles	0	184	8	0	44	276	0	0	0	0	0	0	0	0	44	0	556	
Heavy Trucks	0	0	0	0	4	0	0	0	0	0	0	0	0	0	0	0	4	
Pedestrians	0	0	0	0	0	0	0	0	0	0	0	0	4	0	0	0	4	
Bicycles	0	0	0	0	0	0	0	0	0	0	0	0	0	0	0	0	0	
Railroad																		
Stopped Buses																		

Comments:

LOCATION: Meadow Lakes Dr -- 2nd St
CITY/STATE: Prineville, OR

QC JOB #: 10736511
DATE: Tue, Apr 10 2012

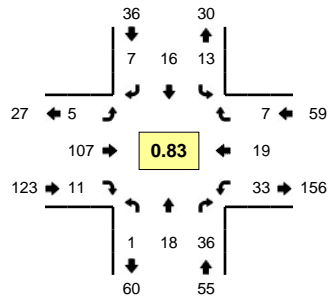

Peak-Hour: 4:40 PM -- 5:40 PM
Peak 15-Min: 5:00 PM -- 5:15 PM

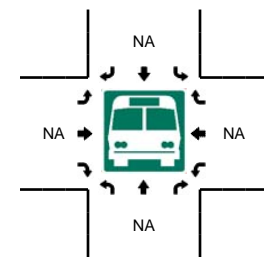
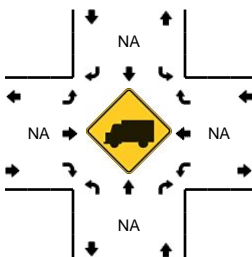
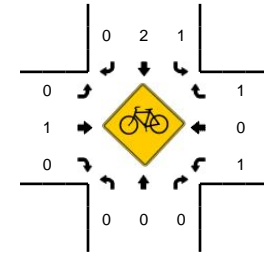
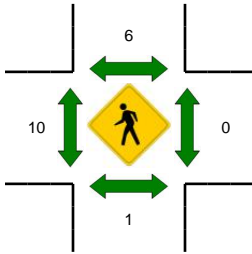
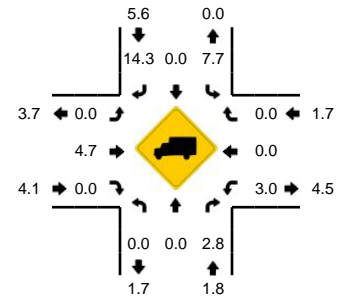

5-Min Count Period Beginning At	Meadow Lakes Dr (Northbound)				Meadow Lakes Dr (Southbound)				2nd St (Eastbound)				2nd St (Westbound)				Total	Hourly Totals	
	Left	Thru	Right	U	Left	Thru	Right	U	Left	Thru	Right	U	Left	Thru	Right	U			
4:00 PM	1	2	4	0	2	1	0	0	0	8	1	0	0	0	0	0	0	19	
4:05 PM	1	2	1	0	3	2	1	0	0	9	1	0	0	7	2	0	0	29	
4:10 PM	0	4	2	0	1	1	0	0	0	7	1	0	0	3	2	0	0	22	
4:15 PM	0	3	3	0	1	1	0	0	0	3	0	0	0	3	4	1	0	19	
4:20 PM	1	1	0	0	0	2	0	0	0	8	0	0	0	2	2	0	0	16	
4:25 PM	0	2	2	0	0	0	0	0	0	14	1	0	0	0	2	0	0	21	
4:30 PM	0	2	2	0	1	0	1	0	0	5	0	0	0	1	0	1	0	13	
4:35 PM	0	1	1	0	1	0	0	0	0	10	2	0	0	3	0	2	0	20	
4:40 PM	0	0	4	0	1	1	1	0	1	4	3	0	0	3	1	1	0	20	
4:45 PM	0	3	1	0	1	3	2	0	1	6	0	0	0	2	2	0	0	21	
4:50 PM	1	3	2	0	3	1	0	0	0	4	0	0	0	3	1	0	0	18	
4:55 PM	0	0	4	0	0	0	1	0	1	5	2	0	0	3	2	0	0	18	236
5:00 PM	0	3	6	0	2	0	0	0	0	9	1	0	0	3	1	1	0	26	243
5:05 PM	0	0	7	0	1	3	0	0	0	12	2	0	0	5	3	1	0	34	248
5:10 PM	0	1	4	0	1	2	2	0	1	8	1	0	0	1	0	1	0	22	248
5:15 PM	0	1	0	0	0	3	0	0	0	10	0	0	0	1	2	1	0	18	247
5:20 PM	0	4	2	0	1	2	1	0	1	9	1	0	0	2	0	1	0	24	255
5:25 PM	0	1	0	0	0	0	0	0	0	16	1	0	0	3	4	0	0	25	259
5:30 PM	0	0	3	0	1	1	0	0	0	10	0	0	0	3	1	1	0	20	266
5:35 PM	0	2	3	0	2	0	0	0	0	14	0	0	0	4	2	0	0	27	273
5:40 PM	0	2	4	0	0	1	0	0	0	7	0	0	0	2	3	0	0	19	272
5:45 PM	0	0	0	0	2	1	0	0	0	11	0	0	0	2	1	0	0	17	268
5:50 PM	0	3	4	0	0	1	0	0	1	6	1	0	0	2	4	0	0	22	272
5:55 PM	0	0	1	0	0	1	2	0	0	12	0	0	0	0	0	2	0	18	272
Peak 15-Min Flowrates	Northbound				Southbound				Eastbound				Westbound				Total		
All Vehicles	0	16	68	0	16	20	8	0	4	116	16	0	36	16	12	0	328		
Heavy Trucks	0	0	4		0	0	0		0	0	0		4	0	0		8		
Pedestrians	0				0				4				0				4		
Bicycles	0	0	0		1	0	0		0	0	0		0	0	0		1		
Railroad																			
Stopped Buses																			

Comments:

LOCATION: Deer St -- 2nd St
CITY/STATE: Prineville, OR

QC JOB #: 10736512
DATE: Tue, Apr 10 2012

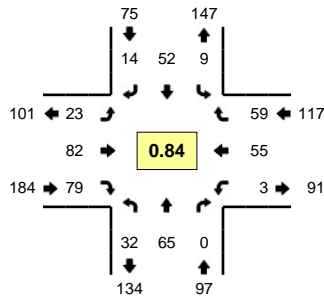

Peak-Hour: 4:45 PM -- 5:45 PM
Peak 15-Min: 5:00 PM -- 5:15 PM

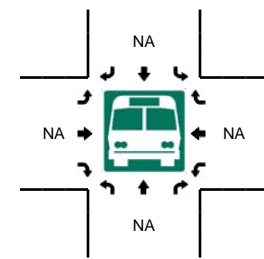
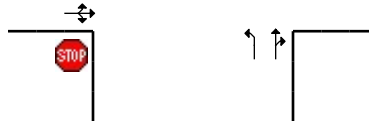
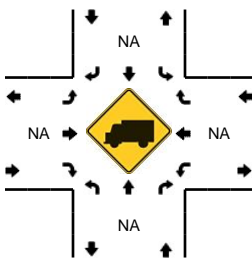
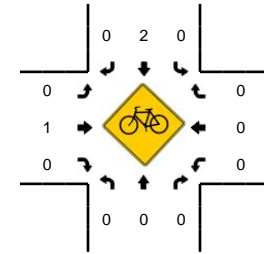
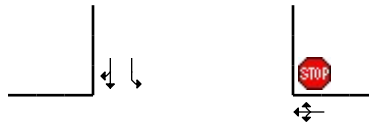
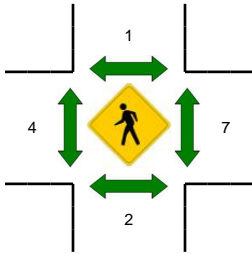
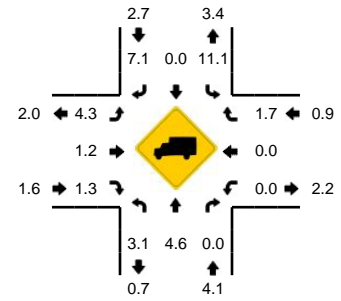

5-Min Count Period Beginning At	Deer St (Northbound)				Deer St (Southbound)				2nd St (Eastbound)				2nd St (Westbound)				Total	Hourly Totals
	Left	Thru	Right	U	Left	Thru	Right	U	Left	Thru	Right	U	Left	Thru	Right	U		
4:00 PM	1	6	0	0	1	5	1	0	4	4	6	0	0	5	3	0	36	
4:05 PM	8	11	0	0	4	5	3	0	2	12	5	0	0	2	5	0	57	
4:10 PM	1	7	1	0	3	6	2	0	3	5	4	0	0	6	4	0	42	
4:15 PM	2	5	0	0	1	2	0	0	2	9	2	0	1	5	2	0	31	
4:20 PM	3	3	0	0	0	3	0	0	1	5	5	0	1	1	4	0	26	
4:25 PM	0	5	0	0	1	2	1	0	1	6	7	0	0	0	4	0	27	
4:30 PM	2	6	1	0	6	4	1	0	1	3	5	0	0	4	3	0	36	
4:35 PM	3	5	0	0	0	6	2	0	2	7	3	0	0	4	2	0	34	
4:40 PM	4	4	0	0	1	3	0	0	1	5	2	0	0	2	1	0	23	
4:45 PM	5	8	0	0	0	3	0	0	2	6	3	0	0	7	3	0	37	
4:50 PM	1	2	0	0	2	4	2	0	1	4	6	0	0	1	8	0	31	
4:55 PM	1	8	0	0	0	2	0	0	4	3	5	0	0	5	5	0	33	413
5:00 PM	4	7	0	0	3	8	2	0	2	7	6	0	0	4	4	0	47	424
5:05 PM	3	3	0	0	1	4	3	0	3	8	10	0	0	6	6	0	47	414
5:10 PM	1	6	0	0	3	2	1	0	3	11	9	0	0	4	7	0	47	419
5:15 PM	1	6	0	0	0	6	0	0	2	7	6	0	2	5	5	0	40	428
5:20 PM	2	9	0	0	0	5	1	0	1	7	5	0	0	4	4	0	38	440
5:25 PM	2	3	0	0	0	1	0	0	0	7	4	0	0	2	5	0	24	437
5:30 PM	3	4	0	0	0	6	2	0	3	7	5	0	1	7	5	0	43	444
5:35 PM	5	7	0	0	0	6	1	0	2	8	12	0	0	5	6	0	52	462
5:40 PM	4	2	0	0	0	5	2	0	0	7	8	0	0	5	1	0	34	473
5:45 PM	1	1	0	0	2	2	2	0	2	9	6	0	1	6	2	0	34	470
5:50 PM	0	3	2	0	0	3	1	0	2	4	5	0	0	6	3	0	29	468
5:55 PM	2	8	0	0	0	1	0	0	0	5	6	0	0	4	4	0	30	465
Peak 15-Min Flowrates	Northbound				Southbound				Eastbound				Westbound				Total	
All Vehicles	32	64	0	0	28	56	24	0	32	104	100	0	0	56	68	0	564	
Heavy Trucks	0	0	0	0	4	0	4	0	4	0	0	0	0	0	0	0	12	
Pedestrians		0				0				4				16			20	
Bicycles	0	0	0	0	0	1	0	0	0	1	0	0	0	0	0	0	2	
Railroad																		
Stopped Buses																		

Comments:

LOCATION: Deer St -- Lamonta Rd
CITY/STATE: Prineville, OR

QC JOB #: 10736513
DATE: Tue, Apr 10 2012

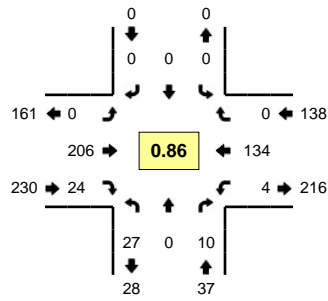

Peak-Hour: 4:00 PM -- 5:00 PM
Peak 15-Min: 4:20 PM -- 4:35 PM

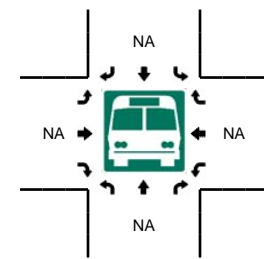
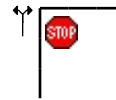
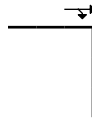
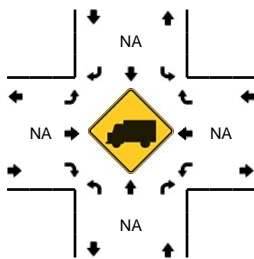
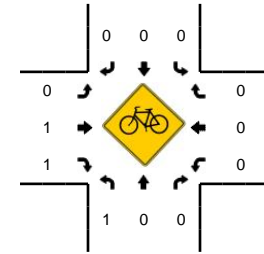
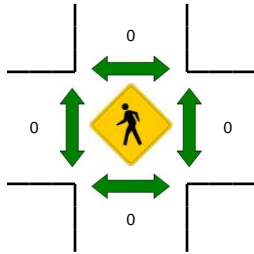
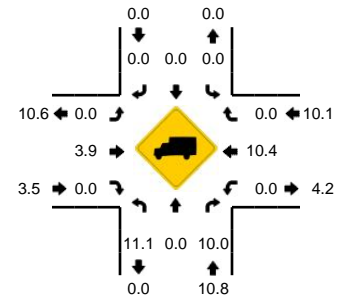

5-Min Count Period Beginning At	Deer St (Northbound)				Deer St (Southbound)				Lamonta Rd (Eastbound)				Lamonta Rd (Westbound)				Total	Hourly Totals
	Left	Thru	Right	U	Left	Thru	Right	U	Left	Thru	Right	U	Left	Thru	Right	U		
4:00 PM	3	0	0	0	0	0	0	0	0	23	4	0	1	6	0	0	37	
4:05 PM	1	0	2	0	0	0	0	0	0	26	3	0	1	10	0	0	43	
4:10 PM	1	0	3	0	0	0	0	0	0	10	2	0	0	18	0	0	34	
4:15 PM	2	0	0	0	0	0	0	0	0	21	0	0	1	13	0	0	37	
4:20 PM	4	0	0	0	0	0	0	0	0	19	0	0	0	15	0	0	38	
4:25 PM	0	0	0	0	0	0	0	0	0	12	5	0	0	16	0	0	33	
4:30 PM	4	0	2	0	0	0	0	0	0	23	1	0	0	17	0	0	47	
4:35 PM	2	0	0	0	0	0	0	0	0	16	0	0	0	10	0	0	28	
4:40 PM	3	0	1	0	0	0	0	0	0	16	4	0	0	10	0	0	34	
4:45 PM	0	0	0	0	0	0	0	0	0	11	1	0	0	4	0	0	16	
4:50 PM	3	0	1	0	0	0	0	0	0	17	4	0	1	12	0	0	38	
4:55 PM	4	0	1	0	0	0	0	0	0	12	0	0	0	3	0	0	20	405
5:00 PM	0	0	2	0	0	0	0	0	0	13	2	0	0	10	0	0	27	395
5:05 PM	1	0	2	0	0	0	0	0	0	20	1	0	1	11	0	0	36	388
5:10 PM	4	0	2	0	0	0	0	0	0	8	1	0	0	8	0	0	23	377
5:15 PM	3	0	0	0	0	0	0	0	0	11	1	0	0	8	0	0	23	363
5:20 PM	1	0	0	0	0	0	0	0	0	10	0	0	0	22	0	0	33	358
5:25 PM	2	0	1	0	0	0	0	0	0	5	0	0	0	9	0	0	17	342
5:30 PM	2	0	1	0	0	0	0	0	0	12	2	0	0	7	0	0	24	319
5:35 PM	1	0	1	0	0	0	0	0	0	10	2	0	0	9	0	0	23	314
5:40 PM	2	0	0	0	0	0	0	0	0	13	1	0	0	5	0	0	21	301
5:45 PM	1	0	0	0	0	0	0	0	0	13	2	0	0	6	0	0	22	307
5:50 PM	0	0	1	0	0	0	0	0	0	16	1	0	0	8	0	0	26	295
5:55 PM	3	0	0	0	0	0	0	0	0	9	0	0	1	7	0	0	20	295
Peak 15-Min Flowrates	Northbound				Southbound				Eastbound				Westbound				Total	
	Left	Thru	Right	U	Left	Thru	Right	U	Left	Thru	Right	U	Left	Thru	Right	U		
All Vehicles	32	0	8	0	0	0	0	0	0	216	24	0	0	192	0	0	472	
Heavy Trucks	4	0	4	0	0	0	0	0	0	12	0	0	0	20	0	0	40	
Pedestrians		0				0				0				0			0	
Bicycles	0	0	0		0	0	0		0	0	0		0	0	0		0	
Railroad																		
Stopped Buses																		

Comments:

LOCATION: Juniper St -- Laughlin Rd
CITY/STATE: Prineville, OR

QC JOB #: 10736514
DATE: Wed, Apr 18 2012

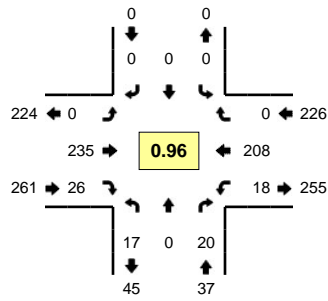

Peak-Hour: 4:30 PM -- 5:30 PM
Peak 15-Min: 4:30 PM -- 4:45 PM

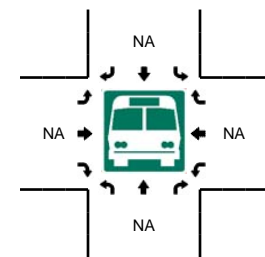
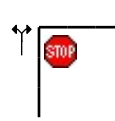
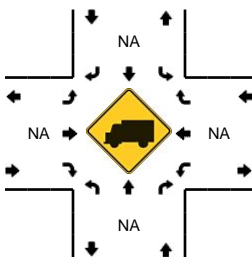
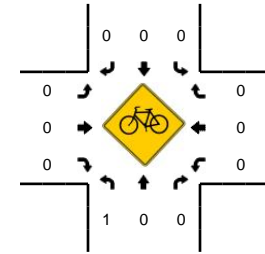
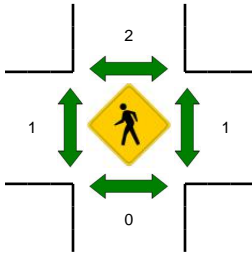
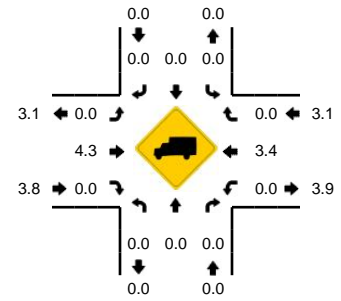

5-Min Count Period Beginning At	Juniper St (Northbound)				Juniper St (Southbound)				Laughlin Rd (Eastbound)				Laughlin Rd (Westbound)				Total	Hourly Totals	
	Left	Thru	Right	U	Left	Thru	Right	U	Left	Thru	Right	U	Left	Thru	Right	U			
4:00 PM	4	0	2	0	0	0	0	0	0	0	20	2	0	1	19	0	0	48	
4:05 PM	0	0	0	0	0	0	0	0	0	0	23	1	0	1	10	0	0	35	
4:10 PM	1	0	0	0	0	0	0	0	0	0	14	0	0	0	16	0	0	31	
4:15 PM	5	0	2	0	0	0	0	0	0	0	18	3	0	1	14	0	0	43	
4:20 PM	0	0	0	0	0	0	0	0	0	0	10	1	0	3	13	0	0	27	
4:25 PM	3	0	0	0	0	0	0	0	0	0	13	1	0	1	18	0	0	36	
4:30 PM	1	0	2	0	0	0	0	0	0	0	24	1	0	3	22	0	0	53	
4:35 PM	0	0	1	0	0	0	0	0	0	0	25	1	0	2	11	0	0	40	
4:40 PM	1	0	0	0	0	0	0	0	0	0	21	1	0	1	19	0	0	43	
4:45 PM	0	0	2	0	0	0	0	0	0	0	25	3	0	2	13	0	0	45	
4:50 PM	3	0	2	0	0	0	0	0	0	0	16	2	0	2	18	0	0	43	
4:55 PM	0	0	1	0	0	0	0	0	0	0	14	2	0	1	18	0	0	36	480
5:00 PM	3	0	3	0	0	0	0	0	0	0	15	2	0	0	21	0	0	44	476
5:05 PM	3	0	1	0	0	0	0	0	0	0	19	2	0	1	21	0	0	47	488
5:10 PM	1	0	0	1	0	0	0	0	0	0	19	3	0	3	15	0	0	42	499
5:15 PM	1	0	3	0	0	0	0	0	0	0	20	3	0	2	15	0	0	44	500
5:20 PM	1	0	2	0	0	0	0	0	0	0	14	3	0	1	18	0	0	39	512
5:25 PM	2	0	3	0	0	0	0	0	0	0	23	3	0	0	17	0	0	48	524
5:30 PM	2	0	1	0	0	0	0	0	0	0	21	1	0	1	20	0	0	46	517
5:35 PM	2	0	1	0	0	0	0	0	0	0	10	1	0	2	9	0	0	25	502
5:40 PM	2	0	1	0	0	0	0	0	0	0	15	1	0	1	10	0	0	30	489
5:45 PM	4	0	1	0	0	0	0	0	0	0	14	1	0	0	15	0	0	35	479
5:50 PM	0	0	1	0	0	0	0	0	0	0	11	1	0	1	10	0	0	24	460
5:55 PM	6	0	1	0	0	0	0	0	0	0	15	1	0	1	23	0	0	47	471
Peak 15-Min Flowrates	Northbound				Southbound				Eastbound				Westbound				Total		
	Left	Thru	Right	U	Left	Thru	Right	U	Left	Thru	Right	U	Left	Thru	Right	U			
All Vehicles	8	0	12	0	0	0	0	0	0	280	12	0	24	208	0	0	544		
Heavy Trucks	0	0	0	0	0	0	0	0	0	16	0	0	0	4	0	0	20		
Pedestrians	0	0	0	0	0	0	0	0	0	0	0	0	0	4	0	0	4		
Bicycles	0	0	0	0	0	0	0	0	0	0	0	0	0	0	0	0	0		
Railroad																			
Stopped Buses																			

Comments:

LOCATION: Combs Flat Rd -- Laughlin Rd
CITY/STATE: Prineville, OR

QC JOB #: 10736515
DATE: Wed, Apr 11 2012

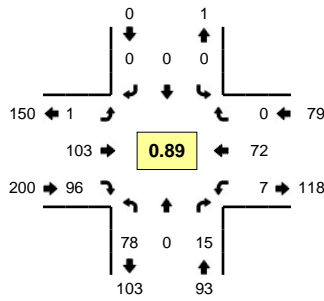

Peak-Hour: 4:00 PM -- 5:00 PM
Peak 15-Min: 4:35 PM -- 4:50 PM

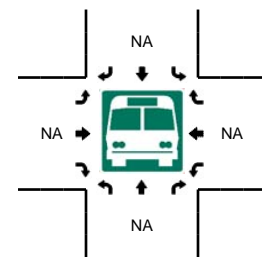
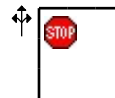
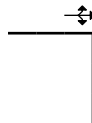
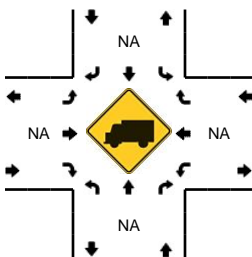
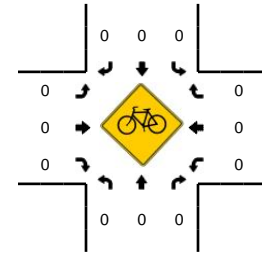
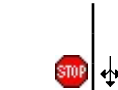
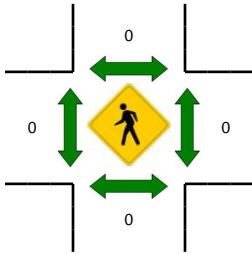
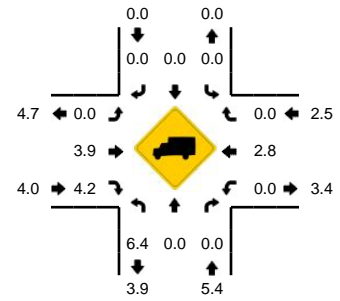

5-Min Count Period Beginning At	Combs Flat Rd (Northbound)				Combs Flat Rd (Southbound)				Laughlin Rd (Eastbound)				Laughlin Rd (Westbound)				Total	Hourly Totals	
	Left	Thru	Right	U	Left	Thru	Right	U	Left	Thru	Right	U	Left	Thru	Right	U			
4:00 PM	8	0	2	0	0	0	0	0	0	5	8	0	0	1	0	0	0	24	
4:05 PM	5	0	3	0	0	0	0	0	0	10	10	0	1	5	0	0	0	34	
4:10 PM	13	0	2	0	0	0	0	0	0	11	10	0	1	6	0	0	0	43	
4:15 PM	5	0	1	0	0	0	0	0	1	6	5	0	0	9	0	0	0	27	
4:20 PM	6	0	2	0	0	0	0	0	0	7	7	0	1	6	0	0	0	29	
4:25 PM	8	0	1	0	0	0	0	0	0	7	8	0	0	5	0	0	0	29	
4:30 PM	7	0	1	0	0	0	0	0	0	4	6	0	1	9	0	0	0	28	
4:35 PM	7	0	1	0	0	0	0	0	0	8	12	0	1	6	0	0	0	35	
4:40 PM	5	0	0	0	0	0	0	0	0	14	7	0	1	10	0	0	0	37	
4:45 PM	7	0	0	0	0	0	0	0	0	14	6	0	0	6	0	0	0	33	
4:50 PM	3	0	0	0	0	0	0	0	0	9	8	0	1	5	0	0	0	26	
4:55 PM	4	0	2	0	0	0	0	0	0	8	9	0	0	4	0	0	0	27	372
5:00 PM	5	0	1	0	0	0	0	0	0	5	3	0	1	2	0	0	0	17	365
5:05 PM	6	0	1	0	0	0	0	0	0	9	14	0	1	4	0	0	0	35	366
5:10 PM	7	0	1	0	0	0	0	0	0	5	5	0	0	2	0	0	0	20	343
5:15 PM	8	0	2	0	0	0	0	0	0	4	6	0	0	6	0	0	0	26	342
5:20 PM	9	0	1	0	0	0	0	0	0	5	8	0	1	7	0	0	0	31	344
5:25 PM	7	0	6	0	0	0	0	0	0	13	5	0	0	2	0	0	0	33	348
5:30 PM	5	0	1	0	0	0	0	0	0	10	2	0	1	7	0	0	0	26	346
5:35 PM	2	0	0	0	0	0	0	0	0	10	10	0	1	2	0	0	0	25	336
5:40 PM	9	0	1	0	0	0	0	0	0	6	6	0	0	8	0	0	0	30	329
5:45 PM	3	0	3	0	0	0	0	0	0	6	7	0	0	6	0	0	0	25	321
5:50 PM	3	0	0	0	0	0	0	0	0	10	6	0	2	5	0	0	0	26	321
5:55 PM	4	0	1	0	0	0	0	0	0	11	6	0	0	7	0	0	0	29	323
Peak 15-Min Flowrates	Northbound				Southbound				Eastbound				Westbound				Total		
All Vehicles	76	0	4	0	0	0	0	0	0	144	100	0	8	88	0	0	420		
Heavy Trucks	0	0	0	0	0	0	0	0	0	0	4	0	0	0	0	0	4		
Pedestrians	0	0	0	0	0	0	0	0	0	0	0	0	0	0	0	0	0		
Bicycles	0	0	0	0	0	0	0	0	0	0	0	0	0	0	0	0	0		
Railroad																			
Stopped Buses																			

Comments:

LOCATION: Juniper St -- US 26
CITY/STATE: Prineville, OR

QC JOB #: 10736516
DATE: Wed, Apr 11 2012

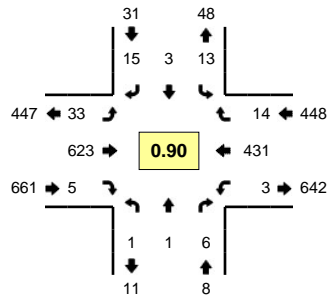

Peak-Hour: 4:35 PM -- 5:35 PM
Peak 15-Min: 5:05 PM -- 5:20 PM

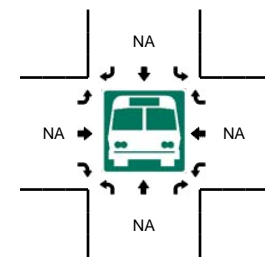
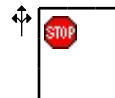
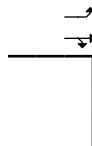
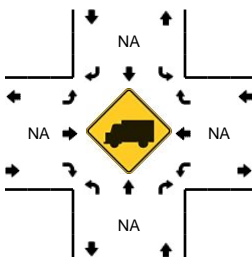
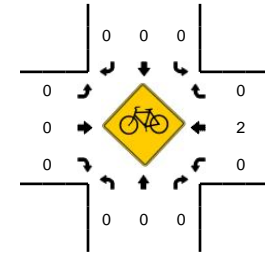
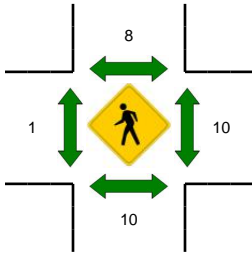
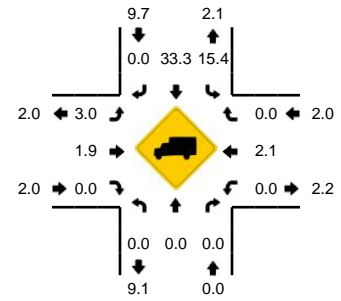

5-Min Count Period Beginning At	Juniper St (Northbound)				Juniper St (Southbound)				US 26 (Eastbound)				US 26 (Westbound)				Total	Hourly Totals
	Left	Thru	Right	U	Left	Thru	Right	U	Left	Thru	Right	U	Left	Thru	Right	U		
4:00 PM	0	0	0	0	3	0	1	0	2	43	0	0	0	47	1	0	97	
4:05 PM	0	2	0	0	0	2	0	0	1	33	0	0	0	46	2	0	86	
4:10 PM	2	0	0	0	0	0	2	0	1	46	0	0	0	37	0	0	88	
4:15 PM	1	0	1	0	3	1	0	0	2	40	2	0	1	49	2	0	102	
4:20 PM	0	1	1	0	2	1	1	0	1	42	0	0	1	41	1	0	92	
4:25 PM	0	0	1	0	1	0	1	0	1	37	1	0	1	44	2	0	89	
4:30 PM	0	1	1	0	0	0	2	0	1	47	2	0	2	32	1	0	89	
4:35 PM	0	0	0	0	0	0	0	0	0	44	1	0	1	40	1	0	87	
4:40 PM	0	0	0	0	2	0	1	0	2	52	0	0	1	33	0	0	91	
4:45 PM	1	0	3	0	2	0	1	0	5	55	0	0	0	36	0	0	103	
4:50 PM	0	0	0	0	4	2	2	0	1	62	0	0	0	30	1	0	102	
4:55 PM	0	0	0	0	0	0	2	0	1	43	0	0	0	43	0	0	89	1115
5:00 PM	0	0	0	0	1	0	0	0	1	41	0	0	0	33	2	0	78	1096
5:05 PM	0	0	0	0	0	0	2	0	5	51	1	0	0	45	0	0	104	1114
5:10 PM	0	1	0	0	0	0	3	0	3	72	1	0	0	28	3	0	111	1137
5:15 PM	0	0	1	0	0	0	1	0	6	58	0	0	1	37	1	0	105	1140
5:20 PM	0	0	0	0	2	0	1	0	2	46	0	0	0	32	1	0	84	1132
5:25 PM	0	0	1	0	1	0	2	0	2	51	2	0	0	31	0	0	90	1133
5:30 PM	0	0	1	0	1	1	0	0	5	48	0	0	0	43	5	0	104	1148
5:35 PM	1	0	0	0	0	0	0	0	4	33	0	0	2	38	2	0	80	1141
5:40 PM	0	1	0	0	0	1	1	0	2	41	1	0	1	39	2	0	89	1139
5:45 PM	1	0	0	0	1	0	2	0	4	31	0	0	0	35	0	0	74	1110
5:50 PM	0	1	1	0	0	1	2	0	2	45	1	0	0	38	1	0	92	1100
5:55 PM	0	1	0	0	2	0	1	0	2	27	1	0	0	31	3	0	68	1079
Peak 15-Min Flowrates	Northbound				Southbound				Eastbound				Westbound				Total	
	Left	Thru	Right	U	Left	Thru	Right	U	Left	Thru	Right	U	Left	Thru	Right	U		
All Vehicles	0	4	4	0	0	0	24	0	56	724	8	0	4	440	16	0	1280	
Heavy Trucks	0	0	0	0	0	0	0	0	4	20	0	0	0	4	0	0	28	
Pedestrians		4				4				0				8			16	
Bicycles	0	0	0		0	0	0		0	0	0		0	0	0		0	
Railroad																		
Stopped Buses																		

Comments:

LOCATION: Fairview St -- Lynn Blvd
CITY/STATE: Prineville, OR

QC JOB #: 10736517
DATE: Wed, Apr 11 2012

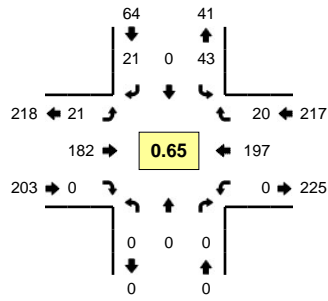

Peak-Hour: 2:40 PM -- 3:40 PM
Peak 15-Min: 2:55 PM -- 3:10 PM

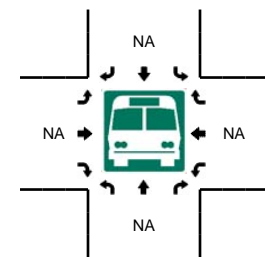
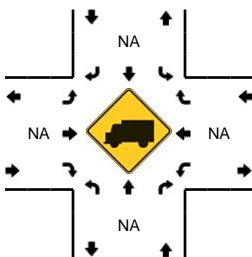
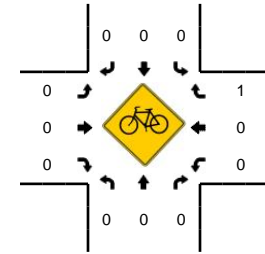
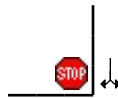
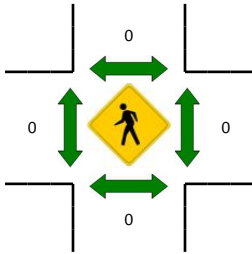
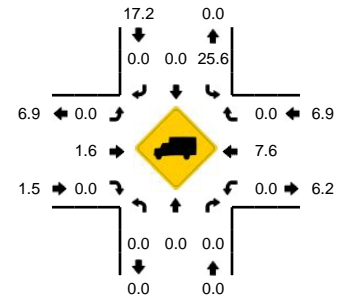

5-Min Count Period Beginning At	Fairview St (Northbound)				Fairview St (Southbound)				Lynn Blvd (Eastbound)				Lynn Blvd (Westbound)				Total	Hourly Totals
	Left	Thru	Right	U	Left	Thru	Right	U	Left	Thru	Right	U	Left	Thru	Right	U		
2:10 PM	0	0	0	0	3	0	1	0	2	7	0	0	0	7	1	0	21	
2:15 PM	0	0	0	0	1	0	1	0	2	18	0	0	0	7	2	0	31	
2:20 PM	0	0	0	0	0	0	0	0	0	11	0	0	0	7	1	0	19	
2:25 PM	0	0	0	0	2	0	1	0	0	12	0	0	0	7	2	0	24	
2:30 PM	0	0	0	0	0	0	0	0	0	8	0	0	0	12	1	0	21	
2:35 PM	0	0	0	0	1	0	1	0	1	8	0	0	0	5	5	0	21	
2:40 PM	0	0	0	0	0	0	0	0	2	16	0	0	0	9	2	0	29	
2:45 PM	0	0	0	0	3	0	0	0	1	21	0	0	0	9	2	0	36	
2:50 PM	0	0	0	0	2	0	0	0	3	16	0	0	0	11	3	0	35	
2:55 PM	0	0	0	0	1	0	4	0	4	21	0	0	0	30	3	0	63	353
3:00 PM	0	0	0	0	7	0	3	0	1	20	0	0	0	19	2	0	52	374
3:05 PM	0	0	0	0	13	0	4	0	4	23	0	0	0	26	0	0	70	422
3:10 PM	0	0	0	0	4	0	4	0	1	14	0	0	0	18	0	0	41	442
3:15 PM	0	0	0	0	3	0	3	0	0	10	0	0	0	22	3	0	41	452
3:20 PM	0	0	0	0	2	0	1	0	4	7	0	0	0	11	1	0	26	459
3:25 PM	0	0	0	0	2	0	0	0	1	11	0	0	0	18	1	0	33	468
3:30 PM	0	0	0	0	4	0	1	0	0	5	0	0	0	12	2	0	24	471
3:35 PM	0	0	0	0	2	0	1	0	0	18	0	0	0	12	1	0	34	484
3:40 PM	0	0	0	0	3	0	1	0	0	11	0	0	0	7	2	0	24	479
3:45 PM	0	0	0	0	5	0	2	0	1	9	0	0	0	11	3	0	31	474
3:50 PM	0	0	0	0	3	0	5	0	1	17	0	0	0	11	0	0	37	476
3:55 PM	0	0	0	0	4	0	1	0	0	20	0	0	0	17	3	0	45	458
4:00 PM	0	0	0	0	1	0	0	0	1	6	0	0	0	7	1	0	16	422
4:05 PM	0	0	0	0	2	0	0	0	0	17	0	0	0	10	0	0	29	381
Peak 15-Min Flowrates	Northbound				Southbound				Eastbound				Westbound				Total	
All Vehicles	0	0	0	0	84	0	44	0	36	256	0	0	0	300	20	0	740	
Heavy Trucks	0	0	0	0	36	0	0	0	0	0	0	0	0	20	0	0	56	
Pedestrians	0	0	0	0	0	0	0	0	0	0	0	0	0	0	0	0	0	
Bicycles	0	0	0	0	0	0	0	0	0	0	0	0	0	0	0	0	0	
Railroad																		
Stopped Buses																		

Comments:

LOCATION: Combs Flat Rd -- US 26
CITY/STATE: Prineville, OR

QC JOB #: 10736518
DATE: Wed, Apr 11 2012

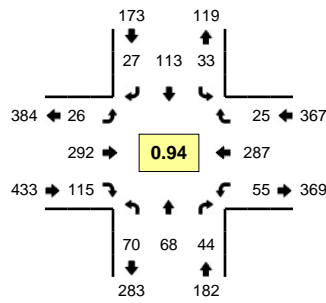

Peak-Hour: 4:30 PM -- 5:30 PM
Peak 15-Min: 5:00 PM -- 5:15 PM

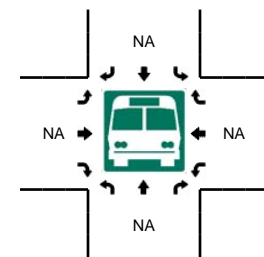
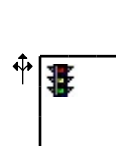
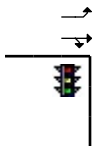
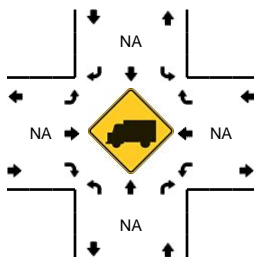
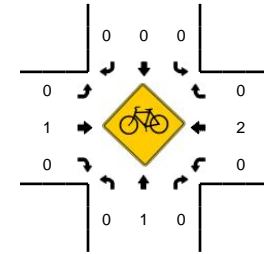
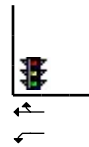
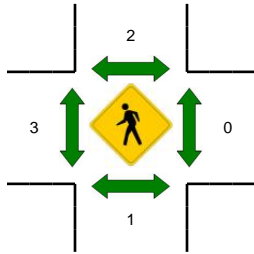
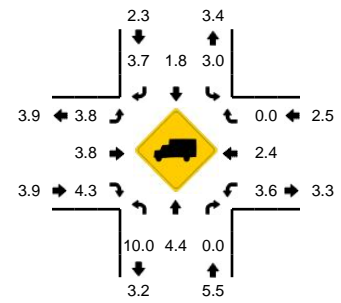

5-Min Count Period Beginning At	Combs Flat Rd (Northbound)				Combs Flat Rd (Southbound)				US 26 (Eastbound)				US 26 (Westbound)				Total	Hourly Totals
	Left	Thru	Right	U	Left	Thru	Right	U	Left	Thru	Right	U	Left	Thru	Right	U		
4:00 PM	10	6	1	0	1	10	3	0	7	28	11	0	7	23	4	0	111	1150
4:05 PM	6	3	2	0	2	5	4	0	5	20	5	0	4	26	1	0	83	1132
4:10 PM	10	6	5	0	2	10	4	0	2	19	10	0	8	24	3	0	103	1144
4:15 PM	2	6	4	0	1	5	0	0	2	24	10	0	7	14	2	0	77	1122
4:20 PM	1	3	3	0	5	8	3	0	1	18	5	0	6	28	2	0	83	1103
4:25 PM	2	11	6	0	1	10	2	0	4	21	3	0	2	13	1	0	76	1079
4:30 PM	10	4	3	0	1	8	2	0	3	20	14	0	7	33	2	0	107	1092
4:35 PM	7	6	9	0	1	11	1	0	2	18	5	0	5	19	1	0	85	1068
4:40 PM	3	7	0	0	1	13	3	0	1	18	6	0	0	20	3	0	75	1060
4:45 PM	7	4	7	0	1	4	3	0	3	31	6	0	7	29	3	0	105	1083
4:50 PM	2	9	2	0	2	18	2	0	2	25	13	0	2	19	2	0	98	1086
4:55 PM	6	2	2	0	5	3	1	0	3	27	8	0	5	34	1	0	97	1100
5:00 PM	5	4	4	0	3	9	4	0	1	25	7	0	3	31	2	0	98	1087
5:05 PM	3	4	4	0	4	9	2	0	2	35	13	0	7	21	3	0	107	1111
5:10 PM	6	8	3	0	2	10	3	0	4	34	15	0	2	14	2	0	103	1111
5:15 PM	9	8	3	0	3	14	2	0	1	20	5	0	6	18	5	0	94	1128
5:20 PM	5	5	6	0	8	6	3	0	2	14	15	0	6	19	1	0	90	1135
5:25 PM	7	7	1	0	2	8	1	0	2	25	8	0	5	30	0	0	96	1155
5:30 PM	4	4	6	0	5	4	5	0	4	14	9	0	5	23	2	0	85	1133
5:35 PM	3	3	5	0	3	7	5	0	1	17	11	0	9	18	0	0	82	1130
5:40 PM	2	7	3	0	1	6	0	0	2	20	8	0	2	27	3	0	81	1136
5:45 PM	5	4	3	0	4	9	3	0	1	21	12	0	2	14	0	0	78	1109
5:50 PM	7	4	3	0	0	8	3	0	2	26	4	0	5	18	1	0	81	1092
5:55 PM	2	4	3	0	4	8	2	0	3	17	3	0	3	17	2	0	68	1063
Peak 15-Min Flowrates	Northbound				Southbound				Eastbound				Westbound				Total	
All Vehicles	56	64	44	0	36	112	36	0	28	376	140	0	48	264	28	0	1232	
Heavy Trucks	0	0	0	0	0	0	0	0	0	4	4	0	0	4	0	0	12	
Pedestrians		0				0				0				0			0	
Bicycles		0				0				0				2			2	
Railroad																		
Stopped Buses																		

Comments:

LOCATION: Main St -- Lynn Blvd
CITY/STATE: Prineville, OR

QC JOB #: 10736519
DATE: Wed, Apr 11 2012

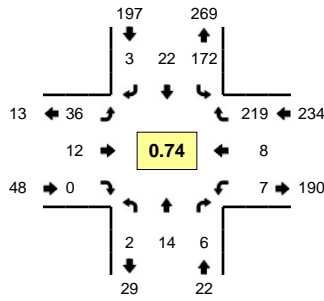

Peak-Hour: 2:50 PM -- 3:50 PM
Peak 15-Min: 2:55 PM -- 3:10 PM

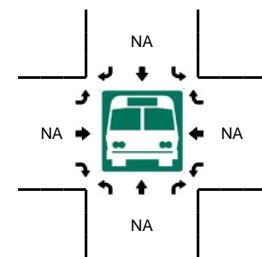
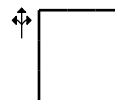
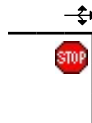
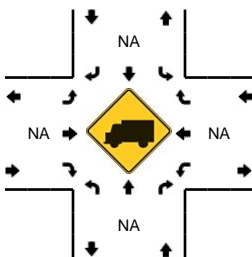
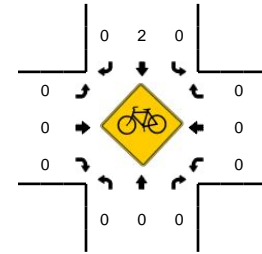
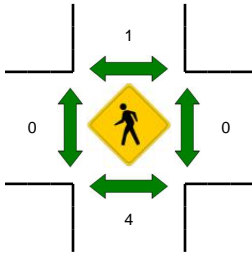
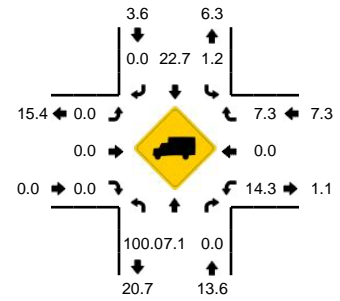

5-Min Count Period Beginning At	Main St (Northbound)				Main St (Southbound)				Lynn Blvd (Eastbound)				Lynn Blvd (Westbound)				Total	Hourly Totals
	Left	Thru	Right	U	Left	Thru	Right	U	Left	Thru	Right	U	Left	Thru	Right	U		
2:20 PM	0	2	0	0	11	1	0	0	0	0	0	0	1	0	9	0	24	
2:25 PM	0	1	2	0	9	0	0	0	0	0	0	0	1	1	9	0	23	
2:30 PM	0	2	0	0	9	1	0	0	0	0	0	0	2	3	8	0	25	
2:35 PM	0	0	0	0	10	1	3	0	1	0	0	0	0	1	7	0	23	
2:40 PM	0	0	1	0	16	3	0	0	0	0	0	0	1	1	11	0	33	
2:45 PM	0	4	2	0	21	2	2	0	0	0	0	0	1	0	8	0	40	
2:50 PM	0	1	2	0	17	0	1	0	0	1	0	0	0	2	12	0	36	
2:55 PM	0	1	0	0	16	0	0	0	19	5	0	0	1	1	27	0	70	382
3:00 PM	0	1	0	0	17	0	1	0	3	4	0	0	0	3	19	0	48	401
3:05 PM	0	1	0	0	15	2	0	0	3	1	0	0	1	1	27	0	51	425
3:10 PM	0	1	1	0	15	0	1	0	2	0	0	0	1	0	27	0	48	455
3:15 PM	0	2	0	0	13	2	0	0	2	0	0	0	0	1	26	0	46	467
3:20 PM	1	2	1	0	9	2	0	0	1	0	0	0	0	0	12	0	28	471
3:25 PM	0	0	0	0	13	0	0	0	3	0	0	0	1	0	17	0	34	482
3:30 PM	0	2	1	0	5	2	0	0	1	0	0	0	0	0	13	0	24	481
3:35 PM	0	0	0	0	20	5	0	0	0	0	0	0	0	0	14	0	39	497
3:40 PM	0	0	0	0	14	5	0	0	0	1	0	0	1	0	12	0	33	497
3:45 PM	1	3	1	0	18	4	0	0	2	0	0	0	2	0	13	0	44	501
3:50 PM	0	1	3	0	15	4	0	0	0	1	0	0	1	0	9	0	34	499
3:55 PM	0	1	0	0	18	4	0	0	0	0	0	0	4	0	17	0	44	473
4:00 PM	0	4	1	0	13	3	0	0	0	0	0	0	1	0	8	0	30	455
4:05 PM	0	3	2	0	17	3	0	0	0	0	0	0	0	1	11	0	37	441
4:10 PM	0	1	0	0	16	0	0	0	0	0	0	0	1	0	13	0	31	424
4:15 PM	0	2	1	0	14	3	0	0	0	0	0	0	0	0	10	0	30	408
Peak 15-Min Flowrates	Northbound				Southbound				Eastbound				Westbound				Total	
All Vehicles	0	12	0	0	192	8	4	0	100	40	0	0	8	20	292	0	676	
Heavy Trucks	0	0	0	0	0	4	0	0	0	0	0	0	4	0	20	0	28	
Pedestrians		8				0				0				0			8	
Bicycles	0	0	0		0	2	0		0	0	0		0	0	0		2	
Railroad																		
Stopped Buses																		

Comments:

LOCATION: Combs Flat Rd -- Lynn Blvd
CITY/STATE: Prineville, OR

QC JOB #: 10736520
DATE: Wed, Apr 18 2012

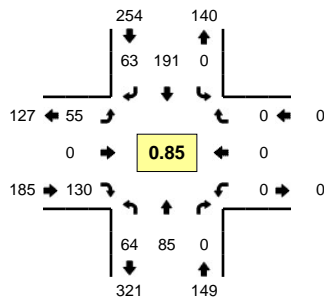

Peak-Hour: 4:45 PM -- 5:45 PM
Peak 15-Min: 5:10 PM -- 5:25 PM

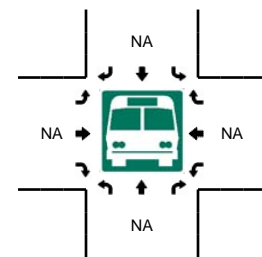
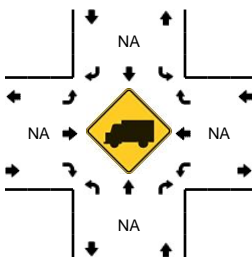
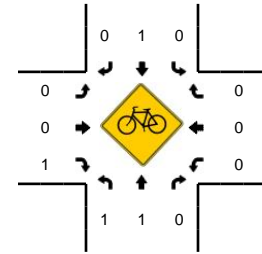
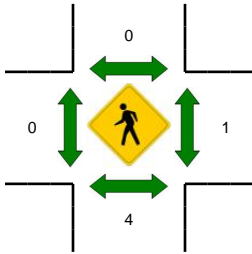
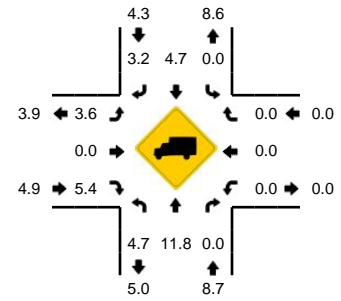

5-Min Count Period Beginning At	Combs Flat Rd (Northbound)				Combs Flat Rd (Southbound)				Lynn Blvd (Eastbound)				Lynn Blvd (Westbound)				Total	Hourly Totals
	Left	Thru	Right	U	Left	Thru	Right	U	Left	Thru	Right	U	Left	Thru	Right	U		
4:00 PM	3	7	0	0	0	17	4	0	6	0	10	0	0	0	0	0	47	538
4:05 PM	5	6	0	0	0	13	3	0	4	0	12	0	0	0	0	0	43	534
4:10 PM	8	8	0	0	0	14	3	0	5	0	10	0	0	0	0	0	48	522
4:15 PM	4	4	0	0	0	18	0	0	2	0	11	0	0	0	0	0	39	512
4:20 PM	8	4	0	0	0	13	4	0	1	0	2	0	0	0	0	0	32	499
4:25 PM	3	9	0	0	0	10	0	0	6	0	6	0	0	0	0	0	34	492
4:30 PM	5	7	0	0	0	21	2	0	2	0	10	0	0	0	0	0	47	500
4:35 PM	2	13	0	0	0	18	5	0	7	0	9	0	0	0	0	0	54	509
4:40 PM	6	3	0	0	0	7	6	0	2	0	7	0	0	0	0	0	31	506
4:45 PM	5	7	0	0	0	11	5	0	9	0	10	0	0	0	0	0	47	508
4:50 PM	5	9	0	0	0	22	3	0	1	0	8	0	0	0	0	0	48	515
4:55 PM	10	8	0	0	0	18	4	0	3	0	5	0	0	0	0	0	48	518
5:00 PM	10	4	0	0	0	12	6	0	7	0	5	0	0	0	0	0	44	515
5:05 PM	2	9	0	0	0	14	5	0	0	0	17	0	0	0	0	0	47	519
5:10 PM	4	11	0	0	0	18	6	0	6	0	14	0	0	0	0	0	59	530
5:15 PM	5	11	0	0	0	19	9	0	3	0	15	0	0	0	0	0	62	553
5:20 PM	4	4	0	0	0	21	5	0	7	0	11	0	0	0	0	0	52	573
5:25 PM	2	7	0	0	0	14	6	0	3	0	7	0	0	0	0	0	39	578
5:30 PM	5	5	0	0	0	11	4	0	6	0	15	0	0	0	0	0	46	577
5:35 PM	7	6	0	0	0	18	4	0	8	0	6	0	0	0	0	0	49	572
5:40 PM	5	4	0	0	0	13	6	0	2	0	17	0	0	0	0	0	47	588
5:45 PM	6	7	0	0	0	10	6	0	4	0	7	0	0	0	0	0	40	581
5:50 PM	6	11	0	0	0	12	8	0	1	0	12	0	0	0	0	0	50	583
5:55 PM	6	3	0	0	0	7	3	0	4	0	4	0	0	0	0	0	27	562
Peak 15-Min Flowrates	Northbound				Southbound				Eastbound				Westbound				Total	
	Left	Thru	Right	U	Left	Thru	Right	U	Left	Thru	Right	U	Left	Thru	Right	U		
All Vehicles	52	104	0	0	0	232	80	0	64	0	160	0	0	0	0	0	692	
Heavy Trucks	0	4	0	0	0	12	0	0	4	0	12	0	0	0	0	0	32	
Pedestrians		8				0				0			4				12	
Bicycles	0	1	0		0	0	0		0	0	1		0	0	0		2	
Railroad																		
Stopped Buses																		

Comments:

LOCATION: Harwood St -- US 26
CITY/STATE: Prineville, OR

QC JOB #: 10736521
DATE: Tue, Apr 10 2012

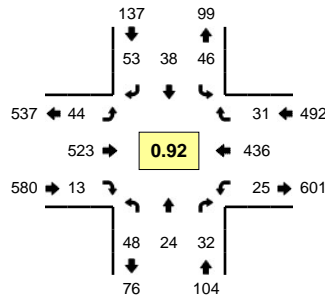

Peak-Hour: 2:30 PM -- 3:30 PM
Peak 15-Min: 2:35 PM -- 2:50 PM

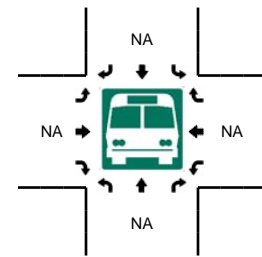
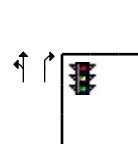
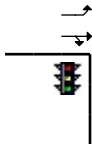
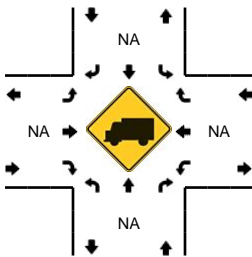
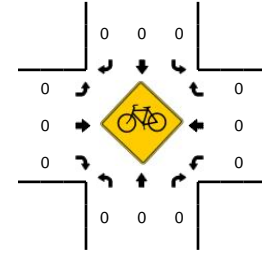
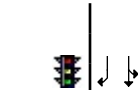
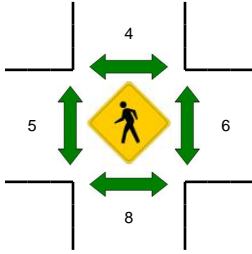
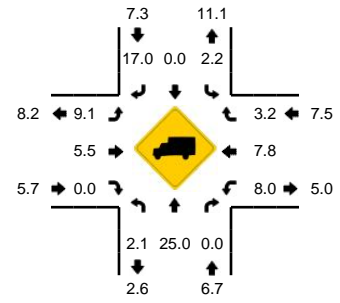

5-Min Count Period Beginning At	Harwood St (Northbound)				Harwood St (Southbound)				US 26 (Eastbound)				US 26 (Westbound)				Total	Hourly Totals
	Left	Thru	Right	U	Left	Thru	Right	U	Left	Thru	Right	U	Left	Thru	Right	U		
2:00 PM	2	2	1	0	2	0	1	0	2	45	1	0	1	42	1	0	100	
2:05 PM	1	0	2	0	4	0	2	0	0	28	2	0	2	40	2	0	83	
2:10 PM	2	1	6	0	1	1	2	0	1	27	1	0	5	31	1	0	79	
2:15 PM	5	1	5	0	1	1	3	0	2	40	2	0	3	33	0	0	96	
2:20 PM	1	3	0	0	1	4	1	0	1	47	2	0	2	43	0	0	105	
2:25 PM	2	1	0	0	0	0	2	0	1	44	3	0	6	31	0	0	90	
2:30 PM	3	1	3	0	3	2	1	0	1	51	4	0	3	36	1	0	109	
2:35 PM	1	1	7	0	0	3	6	0	2	62	1	0	5	37	1	0	126	
2:40 PM	7	1	4	0	0	2	9	0	2	49	0	0	2	39	3	0	118	
2:45 PM	4	2	3	0	4	1	4	0	8	48	0	0	3	36	1	0	114	
2:50 PM	1	2	1	0	6	4	4	0	6	44	1	0	2	29	4	0	104	
2:55 PM	2	2	4	0	11	10	5	0	0	38	2	0	0	25	1	0	100	1224
3:00 PM	3	4	3	0	3	3	4	0	2	45	1	0	0	34	5	0	107	1231
3:05 PM	6	3	3	0	6	2	3	0	5	28	1	0	2	49	4	0	112	1260
3:10 PM	2	3	1	0	1	3	5	0	4	27	1	0	2	39	4	0	92	1273
3:15 PM	8	2	1	0	5	4	7	0	2	40	0	0	3	42	3	0	117	1294
3:20 PM	5	3	0	0	3	1	3	0	7	47	1	0	2	39	2	0	113	1302
3:25 PM	6	0	2	0	4	3	2	0	5	44	1	0	1	31	2	0	101	1313
3:30 PM	0	3	1	0	1	0	6	0	7	51	0	0	0	23	4	0	96	1300
3:35 PM	6	0	0	0	0	1	6	0	7	62	0	0	6	37	0	0	125	1299
3:40 PM	3	2	1	0	6	8	10	0	12	49	2	0	2	26	2	0	123	1304
3:45 PM	3	1	5	0	2	2	2	0	4	48	4	0	1	24	1	0	97	1287
3:50 PM	4	1	0	0	4	3	3	0	3	44	1	0	0	27	4	0	94	1277
3:55 PM	3	3	1	0	3	1	3	0	5	38	1	0	1	33	3	0	95	1272
Peak 15-Min Flowrates	Northbound				Southbound				Eastbound				Westbound				Total	
All Vehicles	48	16	56	0	16	24	76	0	48	636	4	0	40	448	20	0	1432	
Heavy Trucks	0	0	0		0	0	24		8	56	0		4	20	0		112	
Pedestrians		4				0				8				8			20	
Bicycles	0	0	0		0	0	0		0	0	0		0	0	0		0	
Railroad																	0	
Stopped Buses																		

Comments:

LOCATION: 9th St -- US 26
CITY/STATE: Prineville, OR

QC JOB #: 10736522
DATE: Tue, Apr 10 2012

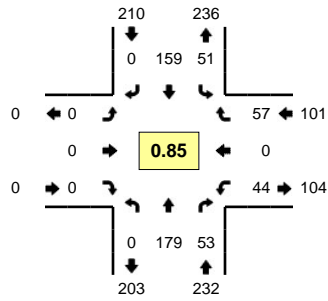

Peak-Hour: 2:45 PM -- 3:45 PM
Peak 15-Min: 2:45 PM -- 3:00 PM

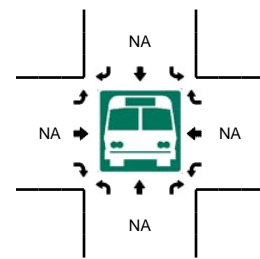
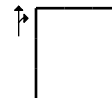
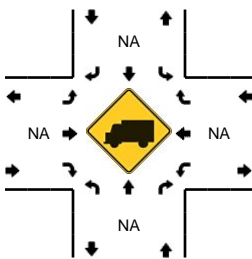
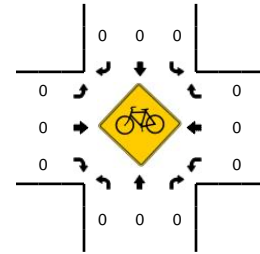
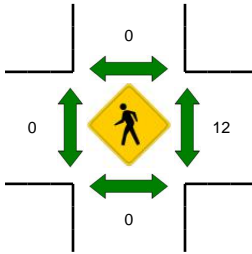
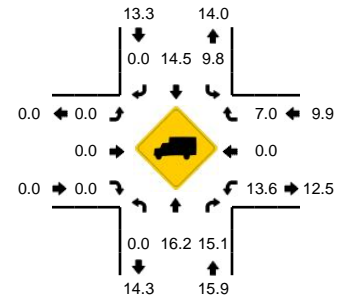

5-Min Count Period Beginning At	9th St (Northbound)				9th St (Southbound)				US 26 (Eastbound)				US 26 (Westbound)				Total	Hourly Totals
	Left	Thru	Right	U	Left	Thru	Right	U	Left	Thru	Right	U	Left	Thru	Right	U		
2:15 PM	0	12	1	0	6	18	0	0	0	0	0	0	5	0	3	0	45	
2:20 PM	0	10	3	0	3	17	0	0	0	0	0	0	1	0	6	0	40	
2:25 PM	0	11	2	0	4	11	0	0	0	0	0	0	4	0	0	0	32	
2:30 PM	0	7	5	0	3	15	0	0	0	0	0	0	2	0	1	0	33	
2:35 PM	0	8	3	0	3	8	0	0	0	0	0	0	3	0	6	0	31	
2:40 PM	0	11	2	0	5	19	0	0	0	0	0	0	7	0	4	0	48	
2:45 PM	0	18	1	0	7	9	0	0	0	0	0	0	3	0	7	0	45	
2:50 PM	0	15	4	0	4	19	0	0	0	0	0	0	5	0	1	0	48	
2:55 PM	0	16	21	0	4	18	0	0	0	0	0	0	3	0	5	0	67	481
3:00 PM	0	8	1	0	4	13	0	0	0	0	0	0	3	0	7	0	36	483
3:05 PM	0	17	7	0	3	11	0	0	0	0	0	0	4	0	1	0	43	500
3:10 PM	0	11	1	0	4	11	0	0	0	0	0	0	3	0	5	0	35	503
3:15 PM	0	15	2	0	2	8	0	0	0	0	0	0	1	0	6	0	34	492
3:20 PM	0	16	2	0	3	10	0	0	0	0	0	0	4	0	2	0	37	489
3:25 PM	0	17	7	0	3	14	0	0	0	0	0	0	7	0	6	0	54	511
3:30 PM	0	10	1	0	4	10	0	0	0	0	0	0	2	0	1	0	28	506
3:35 PM	0	20	5	0	5	14	0	0	0	0	0	0	3	0	5	0	52	527
3:40 PM	0	16	1	0	8	22	0	0	0	0	0	0	6	0	11	0	64	543
3:45 PM	0	9	3	0	3	15	0	0	0	0	0	0	1	0	7	0	38	536
3:50 PM	0	11	3	0	5	14	0	0	0	0	0	0	4	0	4	0	41	529
3:55 PM	0	12	3	0	4	14	0	0	0	0	0	0	6	0	4	0	43	505
4:00 PM	0	13	7	0	3	12	0	0	0	0	0	0	3	0	3	0	41	510
4:05 PM	0	20	4	0	3	11	0	0	0	0	0	0	4	0	5	0	47	514
4:10 PM	0	13	2	0	5	8	0	0	0	0	0	0	2	0	4	0	34	513
Peak 15-Min Flowrates	Northbound				Southbound				Eastbound				Westbound				Total	
All Vehicles	0	196	104	0	60	184	0	0	0	0	0	0	44	0	52	0	640	
Heavy Trucks	0	32	32		16	16	0		0	0	0		12	0	0		108	
Pedestrians		0				0				0				28			28	
Bicycles	0	0	0		0	0	0		0	0	0		0	0	0		0	
Railroad																		
Stopped Buses																		

Comments:

LOCATION: Knowledge St -- US 26
CITY/STATE: Prineville, OR

QC JOB #: 10736523
DATE: Tue, Apr 10 2012

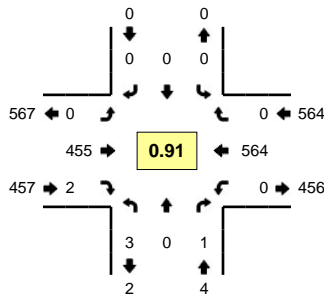

Peak-Hour: 4:25 PM -- 5:25 PM
Peak 15-Min: 5:00 PM -- 5:15 PM

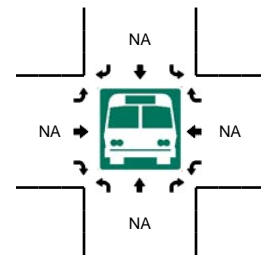
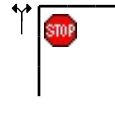
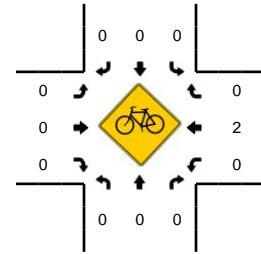
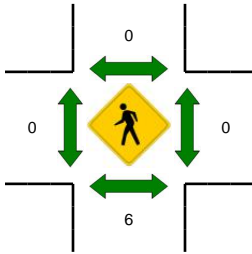
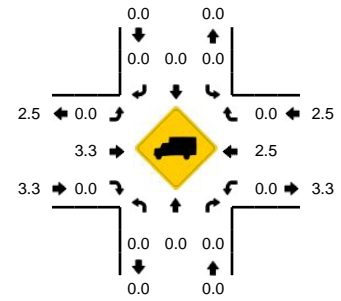

5-Min Count Period Beginning At	Knowledge St (Northbound)				Knowledge St (Southbound)				US 26 (Eastbound)				US 26 (Westbound)				Total	Hourly Totals
	Left	Thru	Right	U	Left	Thru	Right	U	Left	Thru	Right	U	Left	Thru	Right	U		
3:55 PM	0	0	0	0	0	0	0	0	0	28	0	0	0	36	0	0	64	962
4:00 PM	0	0	0	0	0	0	0	0	0	37	0	0	0	54	0	0	91	974
4:05 PM	0	0	0	0	0	0	0	0	0	37	0	0	0	40	0	0	77	967
4:10 PM	0	0	0	0	0	0	0	0	0	36	0	0	0	40	0	0	76	973
4:15 PM	0	0	0	0	0	0	0	0	0	33	0	0	0	44	0	0	77	972
4:20 PM	0	0	0	0	0	0	0	0	0	30	0	0	0	35	0	0	65	945
4:25 PM	0	0	0	0	0	0	0	0	0	37	0	0	0	39	0	0	76	941
4:30 PM	0	0	0	0	0	0	0	0	0	53	1	0	0	42	0	0	96	968
4:35 PM	0	0	1	0	0	0	0	0	0	26	0	0	0	37	0	0	64	928
4:40 PM	0	0	0	0	0	0	0	0	0	37	0	0	0	46	0	0	83	926
4:45 PM	2	0	0	0	0	0	0	0	0	32	0	0	0	54	0	0	88	944
4:50 PM	0	0	0	0	0	0	0	0	0	34	0	0	0	45	0	0	79	936
4:55 PM	0	0	0	0	0	0	0	0	0	39	0	0	0	42	0	0	81	953
5:00 PM	0	0	0	0	0	0	0	0	0	48	0	0	0	46	0	0	94	956
5:05 PM	0	0	0	0	0	0	0	0	0	29	0	0	0	58	0	0	87	966
5:10 PM	0	0	0	0	0	0	0	0	0	44	0	0	0	58	0	0	102	992
5:15 PM	0	0	0	0	0	0	0	0	0	30	0	0	0	51	0	0	81	996
5:20 PM	1	0	0	0	0	0	0	0	0	46	1	0	0	46	0	0	94	1025
5:25 PM	1	0	0	0	0	0	0	0	0	40	1	0	0	34	0	0	76	1025
5:30 PM	0	0	0	0	0	0	0	0	0	33	0	0	0	37	0	0	70	999
5:35 PM	0	0	0	0	0	0	0	0	0	39	0	0	0	35	0	0	74	1009
5:40 PM	0	0	0	0	0	0	0	0	0	29	0	0	0	34	0	0	63	989
5:45 PM	0	0	0	0	0	0	0	0	0	34	0	0	0	49	0	0	83	984
5:50 PM	0	0	0	0	0	0	0	0	0	34	0	0	0	39	0	0	73	978
Peak 15-Min Flowrates	Northbound				Southbound				Eastbound				Westbound				Total	
	Left	Thru	Right	U	Left	Thru	Right	U	Left	Thru	Right	U	Left	Thru	Right	U		
All Vehicles	0	0	0	0	0	0	0	0	0	484	0	0	0	648	0	0	1132	
Heavy Trucks	0	0	0	0	0	0	0	0	0	20	0	0	0	4	0	0	24	
Pedestrians		16				0				0				0			16	
Bicycles	0	0	0		0	0	0			0	0	0		0	1	0	1	
Railroad																		
Stopped Buses																		

Comments:

LOCATION: Tom McCall Rd -- Ochoco Hwy
CITY/STATE: Prineville, OR

QC JOB #: 10547504
DATE: Tue, Oct 19 2010

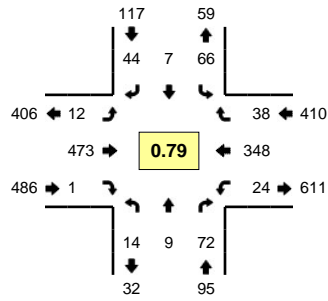

Peak-Hour: 3:05 PM -- 4:05 PM
Peak 15-Min: 3:30 PM -- 3:45 PM

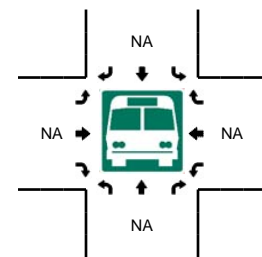
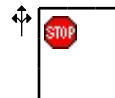
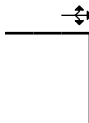
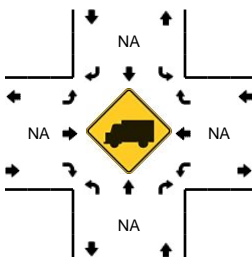
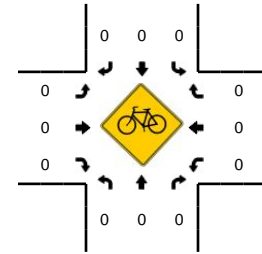
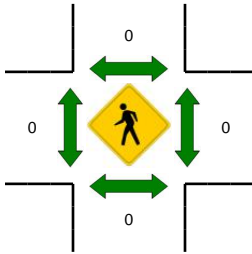
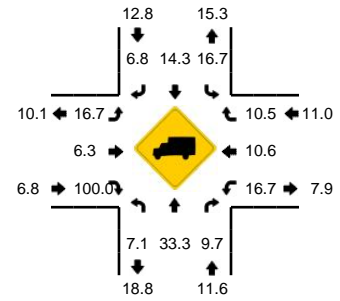

5-Min Count Period Beginning At	Tom McCall Rd (Northbound)				Tom McCall Rd (Southbound)				Ochoco Hwy (Eastbound)				Ochoco Hwy (Westbound)				Total	Hourly Totals
	Left	Thru	Right	U	Left	Thru	Right	U	Left	Thru	Right	U	Left	Thru	Right	U		
2:35 PM	0	1	6	0	1	0	1	0	0	28	2	0	1	17	1	0	58	710
2:40 PM	2	0	2	0	4	0	1	0	0	32	1	0	2	15	3	0	62	720
2:45 PM	2	0	1	0	2	0	2	0	1	43	1	0	1	21	3	0	77	749
2:50 PM	0	0	4	0	4	0	4	0	0	27	1	0	2	18	2	0	62	739
2:55 PM	2	0	1	0	4	1	0	0	0	17	1	0	6	29	1	0	62	742
3:00 PM	0	0	1	0	2	0	1	0	3	41	1	0	1	14	3	0	67	753
3:05 PM	2	1	2	0	8	1	2	0	3	36	0	0	1	28	2	0	86	787
3:10 PM	2	0	4	0	5	0	1	0	0	27	0	0	3	29	6	0	77	809
3:15 PM	0	1	4	0	0	1	1	0	2	36	0	0	1	30	3	0	79	828
3:20 PM	3	1	7	0	5	0	2	0	0	28	0	0	2	28	3	0	79	846
3:25 PM	2	0	3	0	6	0	1	0	0	32	0	0	2	31	1	0	78	854
3:30 PM	0	0	11	0	3	1	10	0	0	33	1	0	2	36	2	0	99	886
3:35 PM	3	1	15	0	5	2	3	0	0	65	0	0	6	27	1	0	128	956
3:40 PM	0	2	13	0	15	1	15	0	3	48	0	0	0	24	2	0	123	1017
3:45 PM	0	1	3	0	7	0	2	0	1	38	0	0	2	26	4	0	84	1024
3:50 PM	1	0	2	0	2	0	3	0	1	47	0	0	1	26	4	0	87	1049
3:55 PM	1	1	5	0	6	0	2	0	0	40	0	0	1	32	5	0	93	1080
4:00 PM	0	1	3	0	4	1	2	0	2	43	0	0	3	31	5	0	95	1108
4:05 PM	3	1	3	0	2	2	3	0	1	22	0	0	1	29	3	0	70	1092
4:10 PM	0	1	3	0	0	0	3	0	0	33	0	0	0	22	7	0	69	1084
4:15 PM	0	0	0	0	4	0	1	0	1	38	0	0	1	30	6	0	81	1086
4:20 PM	2	0	2	0	3	0	0	0	1	26	1	0	0	29	8	0	72	1079
4:25 PM	0	0	5	0	9	0	3	0	2	51	1	0	1	27	1	0	100	1101
4:30 PM	1	0	1	0	10	0	2	0	0	31	1	0	2	31	1	0	80	1082
Peak 15-Min Flowrates	Northbound				Southbound				Eastbound				Westbound				Total	
	Left	Thru	Right	U	Left	Thru	Right	U	Left	Thru	Right	U	Left	Thru	Right	U		
All Vehicles	12	12	156	0	92	16	112	0	12	584	4	0	32	348	20	0	1400	
Heavy Trucks	0	4	4		8	0	8		4	16	4		4	48	0		100	
Pedestrians																	0	
Bicycles	0	0	0		0	0	0		0	0	0		0	0	0		0	
Railroad																	0	
Stopped Buses																	0	

Comments:

LOCATION: Tom McCall Rd -- OR 126
CITY/STATE: Prineville, OR

QC JOB #: 10463801
DATE: Thu, Nov 05 2009

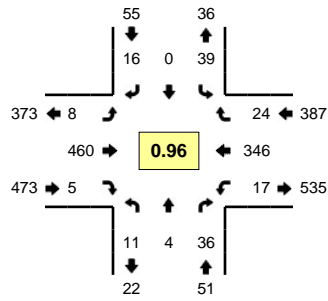

Peak-Hour: 4:15 PM -- 5:15 PM
Peak 15-Min: 5:00 PM -- 5:15 PM

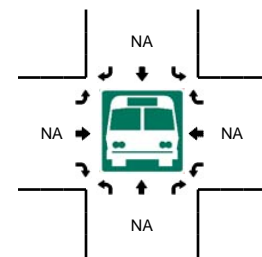
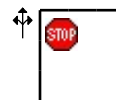
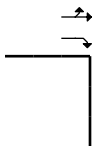
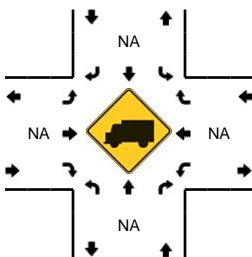
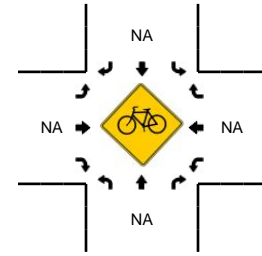
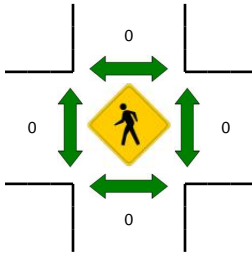
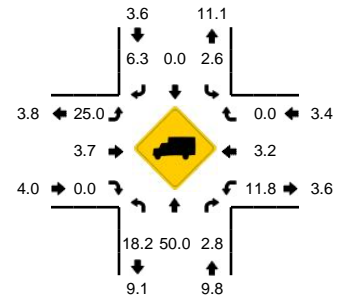

5-Min Count Period Beginning At	Tom McCall Rd (Northbound)			Tom McCall Rd (Southbound)			OR 126 (Eastbound)			OR 126 (Westbound)			Total	Hourly Totals
	Left	Thru	Right	Left	Thru	Right	Left	Thru	Right	Left	Thru	Right		
4:00 PM	1	0	3	4	0	0	1	38	0	1	26	3	77	
4:05 PM	0	0	5	4	0	2	0	33	0	3	33	2	82	
4:10 PM	1	1	3	3	0	0	1	38	1	1	28	6	83	
4:15 PM	1	0	2	4	0	3	1	34	1	2	31	2	81	
4:20 PM	2	2	5	2	0	2	0	33	1	2	32	3	84	
4:25 PM	1	0	5	6	0	3	1	53	0	0	15	1	85	
4:30 PM	1	0	5	2	0	2	0	30	1	0	33	2	76	
4:35 PM	2	0	1	2	0	2	0	39	1	1	29	1	78	
4:40 PM	1	1	3	6	0	1	0	25	0	0	24	3	64	
4:45 PM	0	0	2	0	0	2	1	56	1	2	21	1	86	
4:50 PM	0	1	2	3	0	0	0	37	0	4	24	1	72	
4:55 PM	0	0	2	7	0	0	4	44	0	2	26	3	88	956
5:00 PM	1	0	4	1	0	1	0	39	0	3	22	2	73	952
5:05 PM	0	0	1	3	0	0	0	34	0	0	36	3	77	947
5:10 PM	2	0	4	3	0	0	1	36	0	1	53	2	102	966
5:15 PM	0	0	2	3	0	0	0	40	1	0	29	1	76	961
5:20 PM	0	0	1	2	0	1	0	43	0	1	18	0	66	943
5:25 PM	1	0	3	3	0	2	1	45	0	0	16	2	73	931
5:30 PM	0	0	1	2	0	0	0	47	0	11	28	2	91	946
5:35 PM	1	0	1	0	0	0	0	37	1	0	16	0	56	924
5:40 PM	0	0	1	2	0	1	0	39	2	1	15	3	64	924
5:45 PM	0	0	0	2	0	1	0	37	0	2	22	1	65	903
5:50 PM	0	0	0	3	0	0	0	30	1	2	16	1	53	884
5:55 PM	0	0	0	2	0	0	0	40	0	3	12	0	57	853
Peak 15-Min Flowrates	Northbound			Southbound			Eastbound			Westbound			Total	
	Left	Thru	Right	Left	Thru	Right	Left	Thru	Right	Left	Thru	Right		
All Vehicles	12	0	36	28	0	4	4	436	0	16	444	28	1008	
Heavy Trucks	4	0	0	0	0	0	0	12	0	0	20	0	36	
Pedestrians		0			0			0			0		0	
Bicycles														
Railroad														
Stopped Buses														

Comments:

LOCATION: Tom McCall Rd -- OR 126
CITY/STATE: Prineville, OR

QC JOB #: 10641702
DATE: Tue, Aug 02 2011

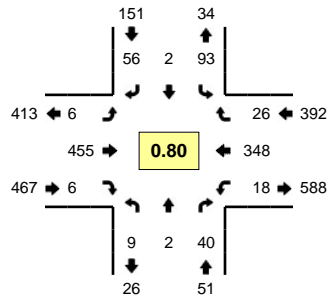

Peak-Hour: 3:20 PM -- 4:20 PM
Peak 15-Min: 3:30 PM -- 3:45 PM

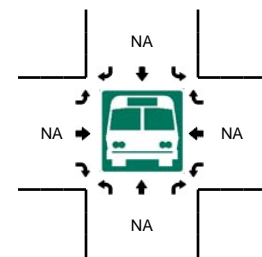
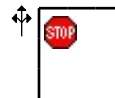
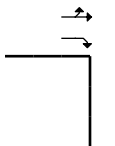
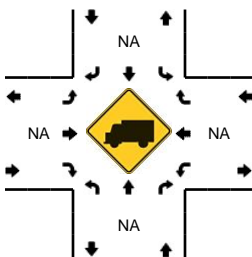
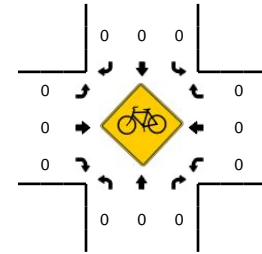
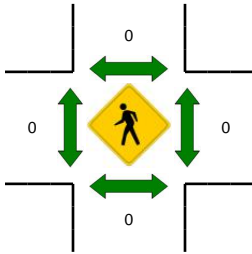
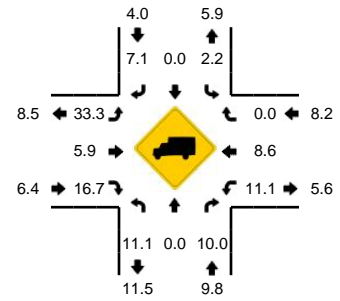

5-Min Count Period Beginning At	Tom McCall Rd (Northbound)				Tom McCall Rd (Southbound)				OR 126 (Eastbound)				OR 126 (Westbound)				Total	Hourly Totals
	Left	Thru	Right	U	Left	Thru	Right	U	Left	Thru	Right	U	Left	Thru	Right	U		
2:50 PM	0	0	3	0	2	0	2	0	4	42	1	0	1	16	6	0	77	
2:55 PM	0	0	4	0	4	0	1	0	2	29	0	0	2	30	1	0	73	806
3:00 PM	1	0	1	0	2	2	3	0	1	27	0	0	1	27	3	0	68	792
3:05 PM	1	1	7	0	3	0	0	0	0	28	0	0	1	26	11	0	78	808
3:10 PM	0	0	0	0	4	0	2	0	0	25	1	0	3	31	3	0	69	810
3:15 PM	0	0	5	0	6	0	1	0	3	26	1	0	1	31	5	0	79	834
3:20 PM	2	0	3	0	4	0	2	0	0	25	0	0	3	38	1	0	78	854
3:25 PM	1	0	3	0	9	0	4	0	1	41	0	0	1	19	2	0	81	875
3:30 PM	1	0	5	0	11	0	8	0	0	51	1	0	1	32	2	0	112	928
3:35 PM	1	1	3	0	20	0	9	0	3	45	0	0	1	24	6	0	113	974
3:40 PM	1	0	3	0	16	0	14	0	0	35	3	0	1	32	1	0	106	1007
3:45 PM	2	0	3	0	4	0	4	0	0	37	0	0	2	26	2	0	80	1014
3:50 PM	0	0	1	0	4	2	1	0	0	37	0	0	1	32	1	0	79	1016
3:55 PM	0	0	2	0	6	0	2	0	0	42	0	0	2	24	2	0	80	1023
4:00 PM	0	0	9	0	6	0	3	0	0	37	0	0	1	25	4	0	85	1040
4:05 PM	0	1	3	0	6	0	6	0	2	35	0	0	2	19	3	0	77	1039
4:10 PM	1	0	2	0	4	0	3	0	0	27	2	0	2	45	1	0	87	1057
4:15 PM	0	0	3	0	3	0	0	0	0	43	0	0	1	32	1	0	83	1061
4:20 PM	0	0	0	0	5	0	3	0	0	33	0	0	1	30	1	0	73	1056
4:25 PM	1	0	3	0	4	0	2	0	1	26	0	0	5	30	2	0	74	1049
4:30 PM	1	1	4	0	4	0	3	0	0	55	1	0	0	37	3	0	109	1046
4:35 PM	0	0	0	0	4	0	7	0	1	38	0	0	1	25	5	0	81	1014
4:40 PM	2	0	1	0	7	0	2	0	0	34	0	0	0	28	3	0	77	985
4:45 PM	0	0	5	0	5	0	2	0	1	30	0	0	1	20	3	0	67	972
Peak 15-Min Flowrates	Northbound				Southbound				Eastbound				Westbound				Total	
	Left	Thru	Right	U	Left	Thru	Right	U	Left	Thru	Right	U	Left	Thru	Right	U		
All Vehicles	12	4	44	0	188	0	124	0	12	524	16	0	12	352	36	0	1324	
Heavy Trucks	4	0	4		0	0	8		4	28	4		0	36	0		88	
Pedestrians		0				0				0				0			0	
Bicycles	0	0	0		0	0	0		0	0	0		0	0	0		0	
Railroad																		
Stopped Buses																		

Comments:

APPENDIX B – ANALYSIS METHODOLOGY

Table B-1 City of Prineville Intersection Operations Performance Standards

Traffic Control	Volume-to-Capacity Ratio Standard	Delay Standard (seconds)	95 th Percentile Queuing Standard
Two-Way Stop Control (TWSC)	≤1.0	≤50 ¹	Storage Capacity
All-Way Stop Control	N/A	≤80 ²	N/A
Signal	≤1.0	≤80 ²	Storage Capacity
Roundabout	≤1.0 ³	N/A	N/A

¹ estimated by lane group

² average for intersection

³ estimated by approach

ODOT Intersection Traffic Operations Performance Standards

ODOT uses volume-to-capacity (V/C) ratio standards to assess intersections operations. Table 6 of the *Oregon Highway Plan* (OHP - Reference 4) provides the peak hour volume-to-capacity ratio targets for all signalized and unsignalized intersections outside the Metro area. The OHP ratios are used to evaluate existing conditions.

Study Intersection Performance Standards

Table B-2 shows the applicable governing jurisdiction, intersection control, and performance standard for each study intersection.

Table B-2 Intersection Volume-to-Capacity Ratio Performance Standards/Targets

Intersection	Jurisdiction	Traffic Control	Maximum Volume-to-Capacity Ratio
1. N Main St & NE 10th St	City of Prineville	Signalized	1
2. N Main St & NE 9th St	City of Prineville	Stop-Controlled	1
3. N Main St & NE 4th St	City of Prineville	Stop-Controlled	1
4. US 26 & NW 9th St	ODOT	Stop-Controlled	0.9
5. NW Hardwood Ave & 3rd St/US 26	ODOT	Signalized	0.95
6. NW Deer St & 3rd St/US 26	ODOT	Signalized	0.95
7. N Main St & 3rd St/US 26	ODOT	Signalized	0.95
8. N Elm St & 3rd St/US 26	ODOT	Signalized	0.95
9. NE Combs Flat Rd & 3rd St/US 26	ODOT	Signalized	0.9
10. NE Laughlin Rd & 3rd St/US26	ODOT	Stop-Controlled	0.95
11. NW Meadows Lakes Dr & N 2nd St	City of Prineville	Stop-Controlled	1
12. NW Deer St & N 2nd St	City of Prineville	Stop-Controlled	1
13. SE Main St & N 2nd St	City of Prineville	Stop-Controlled	1
14. SE Main St & SE Lynn Blvd	City of Prineville	Stop-Controlled	1
15. SE Combs Flat Rd & SE Lynn Blvd	ODOT	Stop-Controlled	0.95
16. WB OR 126 & WB US 26	ODOT	Yield-Controlled	0.9
17. EB OR 126 & EB US 26	ODOT	Yield-Controlled	0.9
18. WB OR 126 & EB US 26	ODOT	Stop-Controlled	0.9
19. O'Neil Hwy & OR 126	ODOT	Stop-Controlled	0.9
20. S Rimrock Rd & OR 126	ODOT	Stop-Controlled	0.9
21. Tom McCall Rd & OR 126	ODOT	Stop-Controlled	0.9
22. SW Millican Rd & OR 126	ODOT	Stop-Controlled	0.9

Signalized Intersection Level-of-Service

Level of service (LOS) is a concept developed to quantify the degree of comfort (including such elements as travel time, number of stops, total amount of stopped delay, and impediments caused by other vehicles) afforded to drivers as they travel through an intersection or roadway segment. Six grades are used to denote the various level of service from “A” to “F”. The six level-of-service grades are described qualitatively for signalized intersections in Table B-3. Additionally, Table B-3 identifies the relationship between level of service and average control delay per vehicle. Control delay is defined to include initial deceleration delay, queue move-up time, stopped delay, and final acceleration delay. Using this definition, Level of Service “D” is generally considered to represent the minimum acceptable design standard.

Table B-3 Level-of-Service Definitions (Signalized Intersections)

Level of Service	Average Delay per Vehicle
A	Very low average control delay, less than 10 seconds per vehicle. This occurs when progression is extremely favorable, and most vehicles arrive during the green phase. Most vehicles do not stop at all. Short cycle lengths may also contribute to low delay.
B	Average control delay is greater than 10 seconds per vehicle and less than or equal to 20 seconds per vehicle. This generally occurs with good progression and/or short cycle lengths. More vehicles stop than for a level of service A, causing higher levels of average delay.
C	Average control delay is greater than 20 seconds per vehicle and less than or equal to 35 seconds per vehicle. These higher delays may result from fair progression and/or longer cycle lengths. Individual cycle failures may begin to appear at this level. The number of vehicles stopping is significant at this level, although many still pass through the intersection without stopping.
D	Average control delay is greater than 35 seconds per vehicle and less than or equal to 55 seconds per vehicle. The influence of congestion becomes more noticeable. Longer delays may result from some combination of unfavorable progression, long cycle length, or high volume/capacity ratios. Many vehicles stop, and the proportion of vehicles not stopping declines. Individual cycle failures are noticeable.
E	Average control delay is greater than 55 seconds per vehicle and less than or equal to 80 seconds per vehicle. This is usually considered to be the limit of acceptable delay. These high delay values generally (but not always) indicate poor progression, long cycle lengths, and high volume/capacity ratios. Individual cycle failures are frequent occurrences.
F	Average control delay is in excess of 80 seconds per vehicle. This is considered to be unacceptable to most drivers. This condition often occurs with oversaturation. It may also occur at high volume/capacity ratios below 1.0 with many individual cycle failures. Poor progression and long cycle lengths may also contribute to such high delay values.

1 Most of the material in this appendix is adapted from the Transportation Research Board, Highway Capacity Manual, (2000).

Table B-4 Level-of-Service Criteria for Signalized Intersections

Level of Service	Average Control Delay per Vehicle (Seconds)
A	<10.0
B	>10 and ≤20
C	>20 and ≤35
D	>35 and ≤55
E	>55 and ≤80
F	>80

Analysis Methodology and Performance Standards

All operations analysis described in this report were performed in accordance with the procedures in the 2000 *Highway Capacity Manual* (Reference 1). Per the *ODOT Analysis Procedures Manual* (APM – Reference 2), intersection operational evaluations were conducted based on the peak 15-minute flow rate observed during the weekday p.m. peak hour. Using the peak 15-

minute flow rate ensures this analysis is based on a reasonable worst-case scenario. For this reason, the analysis reflects conditions that are likely to occur for 15 minutes out of each average weekday p.m. peak hour. The transportation system will likely operate under conditions better than those described in this report during other typical time periods.

The operational analysis results were compared with mobility standards used by the local agencies to assess performance and potential areas for improvement.

City of Prineville Intersection Operations Performance Standards

The City of Prineville has established volume-to-capacity, delay, and queuing standards that vary by traffic control (Reference 3). The standards, summarized in Table B-1, apply to intersections that only include City or County roadways.

Unsignalized Intersection Level-of-Service

Unsignalized intersections include two-way stop-controlled (TWSC) and all-way stop-controlled (AWSC) intersections. The 2000 Highway Capacity Manual (HCM) provides models for estimating control delay at both TWSC and AWSC intersections. A qualitative description of the various service levels associated with an unsignalized intersection is presented in Table B-5. A quantitative definition of level of service for unsignalized intersections is presented in Table B-6. Using this definition, Level of Service “E” is generally considered to represent the minimum acceptable design standard.

Table B-5 Level-of-Service Criteria for Unsignalized Intersections

Level of Service	Average Delay per Vehicle to Minor Street
A	<ul style="list-style-type: none"> • Nearly all drivers find freedom of operation. • Very seldom is there more than one vehicle in queue.
B	<ul style="list-style-type: none"> • Some drivers begin to consider the delay an inconvenience. • Occasionally there is more than one vehicle in queue.
C	<ul style="list-style-type: none"> • Many times there is more than one vehicle in queue. • Most drivers feel restricted, but not objectionably so.
D	<ul style="list-style-type: none"> • Often there is more than one vehicle in queue. • Drivers feel quite restricted.
E	<ul style="list-style-type: none"> • Represents a condition in which the demand is near or equal to the probable maximum number of vehicles that can be accommodated by the movement. • There is almost always more than one vehicle in queue. • Drivers find the delays approaching intolerable levels.
F	<ul style="list-style-type: none"> • Forced flow. • Represents an intersection failure condition that is caused by geometric and/or operational constraints external to the intersection.

Table B-6 Level-of-Service Criteria for Unsignalized Intersections

Level of Service	Average Control Delay per Vehicle (Seconds)
A	<10.0
B	>10.0 and ≤ 15.0
C	>15.0 and ≤ 25.0
D	>25.0 and ≤ 35.0
E	>35.0 and ≤ 50.0
F	>50.0

It should be noted that the level-of-service criteria for unsignalized intersections are somewhat different than the criteria used for signalized intersections. The primary reason for this difference is that drivers expect different levels of performance from different kinds of transportation facilities. The expectation is that a signalized intersection is designed to carry higher traffic volumes than an unsignalized intersection. Additionally, there are a number of driver behavior considerations that combine to make delays at signalized intersections less galling than at unsignalized intersections. For example, drivers at signalized intersections are able to relax during the red interval, while drivers on the minor street approaches to TWSC intersections must remain attentive to the task of identifying acceptable gaps and vehicle conflicts. Also, there is often much more variability in the amount of delay experienced by individual drivers at unsignalized intersections than signalized intersections. For these reasons, it is considered that the control delay threshold for any given level of service is less for an unsignalized intersection than for a signalized intersection. While overall intersection level of service is calculated for AWSC intersections, level of service is only calculated for the minor approaches and the major street left turn movements at TWSC intersections. No delay is assumed to the major street through movements. For TWSC intersections, the overall intersection level of service remains undefined: level of service is only calculated for each minor street lane.

In the performance evaluation of TWSC intersections, it is important to consider other measures of effectiveness (MOEs) in addition to delay, such as v/c ratios for individual movements, average queue lengths, and 95th-percentile queue lengths. By focusing on a single MOE for the worst movement only, such as delay for the minor-street left turn, users may make inappropriate traffic control decisions. The potential for making such inappropriate decisions is likely to be particularly pronounced when the HCM level-of-service thresholds are adopted as legal standards, as is the case in many public agencies.

APPENDIX C – EXISTING CONDITIONS TRAFFIC OPERATIONS AND QUEUING ANALYSIS WORKSHEETS

Table C-1 95th-Percentile Queue Lengths at Signalized Study Intersections

Intersection	95 th Percentile Queue Length (feet)											
	Eastbound			Westbound			Northbound			Southbound		
	L	T	R	L	T	R	L	T	R	L	T	R
N 3 rd Street/NW Harwood	75	375	--	50*	450	--	--	100	50	--	100	50
N 3 rd Street/NW Deer	25*	400	--	25*	250*	--	75	75	--	50	75	--
N 3 rd Street/Main St	75	325	--	50	325	--	75	225**	--	75	300**	--
N 3 rd Street/N Elm	25	250	--	25*	150	--	50	75	--	125	75	--
N 3 rd Street/Combs Flat Rd	75*	425	--	100	250	--	--	225	--	--	200	--

*Volume for 95th percentile queue is metered by upstream signal

**95th percentile volumes exceeds capacity, queue may be longer. Queue shown is maximum after two cycles.

Queues

1: Main St & 10th St



















3/29/13

	→	↘	←	↑	↓
Lane Group	EBT	EBR	WBT	NBT	SBT
Lane Group Flow (vph)	202	136	49	573	503
v/c Ratio	0.55	0.26	0.17	0.43	0.30
Control Delay	17.1	4.2	11.2	8.3	6.9
Queue Delay	0.0	0.0	0.0	0.0	0.0
Total Delay	17.1	4.2	11.2	8.3	6.9
Queue Length 50th (ft)	28	0	7	38	29
Queue Length 95th (ft)	64	16	20	54	42
Internal Link Dist (ft)	370		379	203	3918
Turn Bay Length (ft)		130			
Base Capacity (vph)	472	637	437	1585	1952
Starvation Cap Reductn	0	0	0	0	0
Spillback Cap Reductn	0	0	0	0	0
Storage Cap Reductn	0	0	0	0	0
Reduced v/c Ratio	0.43	0.21	0.11	0.36	0.26
Intersection Summary					

HCM Signalized Intersection Capacity Analysis

1: Main St & 10th St

3/29/13



















												
Movement	EBL	EBT	EBR	WBL	WBT	WBR	NBL	NBT	NBR	SBL	SBT	SBR
Lane Configurations												
Volume (vph)	122	24	98	25	8	2	84	306	22	1	323	38
Ideal Flow (vphpl)	1750	1750	1750	1750	1750	1750	1750	1750	1750	1750	1750	1750
Total Lost time (s)		5.0	5.0		5.0			5.0			5.0	
Lane Util. Factor		1.00	1.00		1.00			0.95			0.95	
Flt		1.00	0.85		0.99			0.99			0.98	
Flt Protected		0.96	1.00		0.97			0.99			1.00	
Satd. Flow (prot)		1680	1488		1676			3265			3272	
Flt Permitted		0.73	1.00		0.67			0.77			0.95	
Satd. Flow (perm)		1272	1488		1171			2543			3122	
Peak-hour factor, PHF	0.72	0.72	0.72	0.72	0.72	0.72	0.72	0.72	0.72	0.72	0.72	0.72
Adj. Flow (vph)	169	33	136	35	11	3	117	425	31	1	449	53
RTOR Reduction (vph)	0	0	104	0	2	0	0	10	0	0	22	0
Lane Group Flow (vph)	0	202	32	0	47	0	0	563	0	0	481	0
Heavy Vehicles (%)	0%	0%	0%	0%	0%	0%	0%	0%	0%	0%	0%	0%
Turn Type	Perm	NA	Perm	Perm	NA		Perm	NA		Perm	NA	
Protected Phases		4			8			2			6	
Permitted Phases	4		4	8			2			6		
Actuated Green, G (s)		8.0	8.0		8.0			16.0			16.0	
Effective Green, g (s)		8.0	8.0		8.0			16.0			16.0	
Actuated g/C Ratio		0.24	0.24		0.24			0.47			0.47	
Clearance Time (s)		5.0	5.0		5.0			5.0			5.0	
Vehicle Extension (s)		3.0	3.0		3.0			3.0			3.0	
Lane Grp Cap (vph)		299	350		275			1196			1469	
v/s Ratio Prot												
v/s Ratio Perm		c0.16	0.02		0.04			c0.22			0.15	
v/c Ratio		0.68	0.09		0.17			0.47			0.33	
Uniform Delay, d1		11.8	10.2		10.4			6.1			5.6	
Progression Factor		1.00	1.00		1.00			1.00			1.00	
Incremental Delay, d2		5.9	0.1		0.3			0.3			0.1	
Delay (s)		17.7	10.3		10.6			6.4			5.8	
Level of Service		B	B		B			A			A	
Approach Delay (s)		14.7			10.6			6.4			5.8	
Approach LOS		B			B			A			A	
Intersection Summary												
HCM 2000 Control Delay			8.3					HCM 2000 Level of Service			A	
HCM 2000 Volume to Capacity ratio			0.54									
Actuated Cycle Length (s)			34.0					Sum of lost time (s)		10.0		
Intersection Capacity Utilization			46.6%					ICU Level of Service		A		
Analysis Period (min)			15									

c Critical Lane Group

HCM Unsignalized Intersection Capacity Analysis

2: Main St & 9th St

3/29/13

												
Movement	EBL	EBT	EBR	WBL	WBT	WBR	NBL	NBT	NBR	SBL	SBT	SBR
Lane Configurations												
Volume (veh/h)	21	5	106	1	2	4	110	414	38	16	415	36
Sign Control		Stop			Stop			Free			Free	
Grade		0%			0%			0%			0%	
Peak Hour Factor	0.95	0.95	0.95	0.95	0.95	0.95	0.95	0.95	0.95	0.95	0.95	0.95
Hourly flow rate (vph)	22	5	112	1	2	4	116	436	40	17	437	38
Pedestrians								2				
Lane Width (ft)								12.0				
Walking Speed (ft/s)								4.0				
Percent Blockage								0				
Right turn flare (veh)												
Median type								None			None	
Median storage (veh)												
Upstream signal (ft)											283	
pX, platoon unblocked	0.91	0.91	0.91	0.91	0.91		0.91					
vC, conflicting volume	1143	1178	439	1274	1196	456	475			476		
vC1, stage 1 conf vol												
vC2, stage 2 conf vol												
vCu, unblocked vol	1107	1146	332	1251	1165	456	372			476		
tC, single (s)	7.1	6.5	6.2	7.1	6.5	6.2	4.1			4.1		
tC, 2 stage (s)												
tF (s)	3.5	4.0	3.3	3.5	4.0	3.3	2.2			2.2		
p0 queue free %	85	97	83	99	99	99	89			98		
cM capacity (veh/h)	150	161	648	100	156	609	1073			1097		
Direction, Lane #	EB 1	WB 1	NB 1	NB 2	SB 1	SB 2						
Volume Total	139	7	116	476	454	38						
Volume Left	22	1	116	0	17	0						
Volume Right	112	4	0	40	0	38						
cSH	394	238	1073	1700	1097	1700						
Volume to Capacity	0.35	0.03	0.11	0.28	0.02	0.02						
Queue Length 95th (ft)	40	2	9	0	1	0						
Control Delay (s)	19.0	20.6	8.8	0.0	0.5	0.0						
Lane LOS	C	C	A		A							
Approach Delay (s)	19.0	20.6	1.7		0.4							
Approach LOS	C	C										



















Intersection Summary

Average Delay		3.3										
Intersection Capacity Utilization		73.1%		ICU Level of Service						D		
Analysis Period (min)		15										

HCM Unsignalized Intersection Capacity Analysis

3: Main St & 4th St

3/29/13

												
Movement	EBL	EBT	EBR	WBL	WBT	WBR	NBL	NBT	NBR	SBL	SBT	SBR
Lane Configurations												
Volume (veh/h)	18	22	59	9	9	57	18	317	38	78	273	25
Sign Control		Stop			Stop			Free			Free	
Grade		0%			0%			0%			0%	
Peak Hour Factor	0.92	0.92	0.92	0.92	0.92	0.92	0.92	0.92	0.92	0.92	0.92	0.92
Hourly flow rate (vph)	20	24	64	10	10	62	20	345	41	85	297	27
Pedestrians		4			10			9			11	
Lane Width (ft)		12.0			12.0			12.0			12.0	
Walking Speed (ft/s)		4.0			4.0			4.0			4.0	
Percent Blockage		0			1			1			1	
Right turn flare (veh)												
Median type								None			None	
Median storage (veh)												
Upstream signal (ft)								331				
pX, platoon unblocked	0.90	0.90		0.90	0.90	0.90				0.90		
vC, conflicting volume	945	919	323	966	912	386	328			396		
vC1, stage 1 conf vol												
vC2, stage 2 conf vol												
vCu, unblocked vol	886	857	323	909	849	268	328			278		
tC, single (s)	7.1	6.6	6.2	7.2	6.5	6.2	4.2			4.1		
tC, 2 stage (s)												
tF (s)	3.5	4.1	3.3	3.6	4.0	3.3	2.3			2.2		
p0 queue free %	90	90	91	94	96	91	98			93		
cM capacity (veh/h)	194	234	710	170	244	689	1205			1146		
Direction, Lane #	EB 1	WB 1	NB 1	NB 2	SB 1	SB 2						
Volume Total	108	82	20	386	85	324						
Volume Left	20	10	20	0	85	0						
Volume Right	64	62	0	41	0	27						
cSH	367	435	1205	1700	1146	1700						
Volume to Capacity	0.29	0.19	0.02	0.23	0.07	0.19						
Queue Length 95th (ft)	31	18	1	0	6	0						
Control Delay (s)	18.8	15.2	8.0	0.0	8.4	0.0						
Lane LOS	C	C	A		A							
Approach Delay (s)	18.8	15.2	0.4		1.7							
Approach LOS	C	C										
Intersection Summary												
Average Delay			4.1									
Intersection Capacity Utilization			46.5%		ICU Level of Service					A		
Analysis Period (min)			15									

HCM Unsignalized Intersection Capacity Analysis

4: US 26 & NW 9th St

3/29/13



Movement	WBL	WBR	NBT	NBR	SBL	SBT
Lane Configurations	Y		T			T
Volume (veh/h)	44	57	192	53	51	170
Sign Control	Stop		Free			Free
Grade	0%		0%			0%
Peak Hour Factor	0.85	0.85	0.85	0.85	0.85	0.85
Hourly flow rate (vph)	52	67	226	62	60	200
Pedestrians	12					
Lane Width (ft)	12.0					
Walking Speed (ft/s)	4.0					
Percent Blockage	1					
Right turn flare (veh)						
Median type			None			None
Median storage (veh)						
Upstream signal (ft)						
pX, platoon unblocked						
vC, conflicting volume	589	269			300	
vC1, stage 1 conf vol						
vC2, stage 2 conf vol						
vCu, unblocked vol	589	269			300	
tC, single (s)	6.5	6.3			4.2	
tC, 2 stage (s)						
tF (s)	3.6	3.4			2.3	
p0 queue free %	88	91			95	
cM capacity (veh/h)	425	750			1204	









Direction, Lane #	WB 1	NB 1	SB 1
Volume Total	119	288	260
Volume Left	52	0	60
Volume Right	67	62	0
cSH	562	1700	1204
Volume to Capacity	0.21	0.17	0.05
Queue Length 95th (ft)	21	0	4
Control Delay (s)	13.1	0.0	2.2
Lane LOS	B		A
Approach Delay (s)	13.1	0.0	2.2
Approach LOS	B		

Intersection Summary			
Average Delay		3.2	
Intersection Capacity Utilization	44.0%	ICU Level of Service	A
Analysis Period (min)	15		

Queues

5: NW Harwood Ave & US 26





















3/29/13

								
Lane Group	EBL	EBT	WBL	WBT	NBT	NBR	SBT	SBR
Lane Group Flow (vph)	48	623	27	542	78	35	91	58
v/c Ratio	0.10	0.59	0.06	0.57	0.34	0.10	0.35	0.19
Control Delay	5.1	13.5	5.0	14.5	29.0	0.6	28.4	4.9
Queue Delay	0.0	0.0	0.0	0.0	0.0	0.0	0.0	0.0
Total Delay	5.1	13.5	5.0	14.5	29.0	0.6	28.4	4.9
Queue Length 50th (ft)	5	91	3	139	23	0	27	0
Queue Length 95th (ft)	22	410	14	341	82	1	91	18
Internal Link Dist (ft)		447		993	183		612	
Turn Bay Length (ft)	100		100			75		75
Base Capacity (vph)	577	1400	566	1368	403	547	462	477
Starvation Cap Reductn	0	0	0	0	0	0	0	0
Spillback Cap Reductn	0	0	0	0	0	0	0	0
Storage Cap Reductn	0	0	0	0	0	0	0	0
Reduced v/c Ratio	0.08	0.45	0.05	0.40	0.19	0.06	0.20	0.12
Intersection Summary								

HCM Signalized Intersection Capacity Analysis

5: NW Harwood Ave & US 26

3/29/13

												
Movement	EBL	EBT	EBR	WBL	WBT	WBR	NBL	NBT	NBR	SBL	SBT	SBR
Lane Configurations												
Volume (vph)	44	560	13	25	467	31	48	24	32	46	38	53
Ideal Flow (vphpl)	1750	1750	1750	1750	1750	1750	1750	1750	1750	1750	1750	1750
Total Lost time (s)	5.0	5.0		5.0	5.0			5.0	5.0		5.0	5.0
Lane Util. Factor	1.00	1.00		1.00	1.00			1.00	1.00		1.00	1.00
Frbp, ped/bikes	1.00	1.00		1.00	1.00			1.00	0.97		1.00	0.97
Flpb, ped/bikes	1.00	1.00		1.00	1.00			1.00	1.00		1.00	1.00
Frt	1.00	1.00		1.00	0.99			1.00	0.85		1.00	0.85
Flt Protected	0.95	1.00		0.95	1.00			0.97	1.00		0.97	1.00
Satd. Flow (prot)	1524	1646		1538	1607			1538	1446		1678	1238
Flt Permitted	0.35	1.00		0.33	1.00			0.74	1.00		0.79	1.00
Satd. Flow (perm)	564	1646		540	1607			1183	1446		1356	1238
Peak-hour factor, PHF	0.92	0.92	0.92	0.92	0.92	0.92	0.92	0.92	0.92	0.92	0.92	0.92
Adj. Flow (vph)	48	609	14	27	508	34	52	26	35	50	41	58
RTOR Reduction (vph)	0	1	0	0	3	0	0	0	30	0	0	50
Lane Group Flow (vph)	48	622	0	27	539	0	0	78	5	0	91	8
Confl. Peds. (#/hr)	4		8	8		4	5		6	6		5
Heavy Vehicles (%)	9%	6%	0%	8%	8%	3%	2%	25%	0%	2%	0%	17%
Turn Type	pm+pt	NA		pm+pt	NA		Perm	NA	Perm	Perm	NA	Perm
Protected Phases	5	2		1	6			8			4	
Permitted Phases	2			6			8		8	4		4
Actuated Green, G (s)	36.2	33.0		33.4	31.6			8.5	8.5		8.5	8.5
Effective Green, g (s)	36.2	33.0		33.4	31.6			8.5	8.5		8.5	8.5
Actuated g/C Ratio	0.62	0.57		0.57	0.54			0.15	0.15		0.15	0.15
Clearance Time (s)	5.0	5.0		5.0	5.0			5.0	5.0		5.0	5.0
Vehicle Extension (s)	2.5	3.5		2.5	3.5			2.5	2.5		2.5	2.5
Lane Grp Cap (vph)	402	931		340	871			172	210		197	180
v/s Ratio Prot	c0.01	c0.38		0.00	0.34							
v/s Ratio Perm	0.07			0.04				0.07	0.00		c0.07	0.01
v/c Ratio	0.12	0.67		0.08	0.62			0.45	0.02		0.46	0.05
Uniform Delay, d1	4.9	8.8		5.8	9.2			22.8	21.3		22.8	21.4
Progression Factor	1.00	1.00		1.00	1.00			1.00	1.00		1.00	1.00
Incremental Delay, d2	0.1	1.9		0.1	1.4			1.4	0.0		1.2	0.1
Delay (s)	5.0	10.7		5.9	10.6			24.2	21.4		24.1	21.5
Level of Service	A	B		A	B			C	C		C	C
Approach Delay (s)		10.3			10.4			23.3			23.1	
Approach LOS		B			B			C			C	
Intersection Summary												
HCM 2000 Control Delay			12.6			HCM 2000 Level of Service			B			
HCM 2000 Volume to Capacity ratio			0.61									
Actuated Cycle Length (s)			58.3			Sum of lost time (s)		15.0				
Intersection Capacity Utilization			60.7%			ICU Level of Service			B			
Analysis Period (min)			15									
c Critical Lane Group												

Queues
6: NW Deer St & US 26

3/29/13

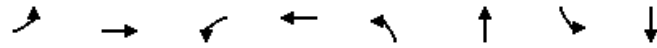





















Lane Group	EBL	EBT	WBL	WBT	NBL	NBT	SBL	SBT
Lane Group Flow (vph)	26	696	16	516	73	93	22	76
v/c Ratio	0.06	0.64	0.05	0.47	0.29	0.27	0.09	0.22
Control Delay	5.7	10.8	5.8	8.0	20.8	12.9	18.4	12.0
Queue Delay	0.0	0.0	0.0	0.0	0.0	0.0	0.0	0.0
Total Delay	5.7	10.8	5.8	8.0	20.8	12.9	18.4	12.0
Queue Length 50th (ft)	2	96	1	60	14	9	4	6
Queue Length 95th (ft)	15	334	11	206	61	53	25	44
Internal Link Dist (ft)		993		885		233		2644
Turn Bay Length (ft)	100		100		50		50	
Base Capacity (vph)	705	1623	521	1621	534	679	523	691
Starvation Cap Reductn	0	0	0	0	0	0	0	0
Spillback Cap Reductn	0	0	0	0	0	0	0	0
Storage Cap Reductn	0	0	0	0	0	0	0	0
Reduced v/c Ratio	0.04	0.43	0.03	0.32	0.14	0.14	0.04	0.11

Intersection Summary

HCM Signalized Intersection Capacity Analysis









6: NW Deer St & US 26

3/29/13

												
Movement	EBL	EBT	EBR	WBL	WBT	WBR	NBL	NBT	NBR	SBL	SBT	SBR
Lane Configurations												
Volume (vph)	23	590	29	14	426	33	65	42	41	20	30	37
Ideal Flow (vphpl)	1750	1750	1750	1750	1750	1750	1750	1750	1750	1750	1750	1750
Total Lost time (s)	5.0	5.0		5.0	5.0		5.0	5.0		5.0	5.0	
Lane Util. Factor	1.00	1.00		1.00	1.00		1.00	1.00		1.00	1.00	
Frpb, ped/bikes	1.00	1.00		1.00	1.00		1.00	0.99		1.00	0.99	
Flpb, ped/bikes	1.00	1.00		1.00	1.00		1.00	1.00		0.99	1.00	
Frt	1.00	0.99		1.00	0.99		1.00	0.93		1.00	0.92	
Flt Protected	0.95	1.00		0.95	1.00		0.95	1.00		0.95	1.00	
Satd. Flow (prot)	1593	1684		1654	1681		1656	1508		1652	1537	
Flt Permitted	0.44	1.00		0.31	1.00		0.71	1.00		0.70	1.00	
Satd. Flow (perm)	733	1684		542	1681		1233	1508		1211	1537	
Peak-hour factor, PHF	0.89	0.89	0.89	0.89	0.89	0.89	0.89	0.89	0.89	0.89	0.89	0.89
Adj. Flow (vph)	26	663	33	16	479	37	73	47	46	22	34	42
RTOR Reduction (vph)	0	3	0	0	4	0	0	38	0	0	35	0
Lane Group Flow (vph)	26	693	0	16	512	0	73	55	0	22	41	0
Confl. Peds. (#/hr)	7		14	14		7	4		7	7		4
Heavy Vehicles (%)	4%	3%	3%	0%	3%	0%	0%	7%	5%	0%	3%	3%
Turn Type	Perm	NA		Perm	NA		Perm	NA		Perm	NA	
Protected Phases		2			6			8			4	
Permitted Phases	2			6			8			4		
Actuated Green, G (s)	27.4	27.4		27.4	27.4		7.6	7.6		7.6	7.6	
Effective Green, g (s)	27.4	27.4		27.4	27.4		7.6	7.6		7.6	7.6	
Actuated g/C Ratio	0.61	0.61		0.61	0.61		0.17	0.17		0.17	0.17	
Clearance Time (s)	5.0	5.0		5.0	5.0		5.0	5.0		5.0	5.0	
Vehicle Extension (s)	3.0	3.0		3.0	3.0		2.5	2.5		2.5	2.5	
Lane Grp Cap (vph)	446	1025		330	1023		208	254		204	259	
v/s Ratio Prot		c0.41			0.30			0.04			0.03	
v/s Ratio Perm	0.04			0.03			c0.06			0.02		
v/c Ratio	0.06	0.68		0.05	0.50		0.35	0.22		0.11	0.16	
Uniform Delay, d1	3.6	5.9		3.5	5.0		16.5	16.1		15.8	16.0	
Progression Factor	1.00	1.00		1.00	1.00		1.00	1.00		1.00	1.00	
Incremental Delay, d2	0.1	1.8		0.1	0.4		0.7	0.3		0.2	0.2	
Delay (s)	3.6	7.6		3.6	5.3		17.3	16.4		16.0	16.2	
Level of Service	A	A		A	A		B	B		B	B	
Approach Delay (s)		7.5			5.3			16.8			16.1	
Approach LOS		A			A			B			B	
Intersection Summary												
HCM 2000 Control Delay			8.3				HCM 2000 Level of Service				A	
HCM 2000 Volume to Capacity ratio			0.61									
Actuated Cycle Length (s)			45.0				Sum of lost time (s)				10.0	
Intersection Capacity Utilization			56.0%				ICU Level of Service				B	
Analysis Period (min)			15									
c Critical Lane Group												

Queues
7: Main St & US 26





















3/29/13

								
Lane Group	EBL	EBT	WBL	WBT	NBL	NBT	SBL	SBT
Lane Group Flow (vph)	170	513	53	443	83	213	78	264
v/c Ratio	0.45	0.67	0.15	0.78	0.33	0.60	0.28	0.73
Control Delay	14.0	23.8	10.6	32.3	24.3	35.6	23.1	40.6
Queue Delay	0.0	0.0	0.0	0.0	0.0	0.0	0.0	0.0
Total Delay	14.0	23.8	10.6	32.3	24.3	35.6	23.1	40.6
Queue Length 50th (ft)	43	218	12	192	28	90	26	113
Queue Length 95th (ft)	85	386	32	332	72	190	68	232
Internal Link Dist (ft)		885		1205		239		251
Turn Bay Length (ft)	100		100		75		75	
Base Capacity (vph)	403	970	464	957	248	431	277	437
Starvation Cap Reductn	0	0	0	0	0	0	0	0
Spillback Cap Reductn	0	0	0	0	0	0	0	0
Storage Cap Reductn	0	0	0	0	0	0	0	0
Reduced v/c Ratio	0.42	0.53	0.11	0.46	0.33	0.49	0.28	0.60
Intersection Summary								

HCM Signalized Intersection Capacity Analysis

7: Main St & US 26

3/29/13

												
Movement	EBL	EBT	EBR	WBL	WBT	WBR	NBL	NBT	NBR	SBL	SBT	SBR
Lane Configurations												
Volume (vph)	160	404	78	50	354	62	78	165	35	73	179	70
Ideal Flow (vphpl)	1750	1750	1750	1750	1750	1750	1750	1750	1750	1750	1750	1750
Total Lost time (s)	5.0	5.0		5.0	5.0		5.0	5.0		5.0	5.0	
Lane Util. Factor	1.00	1.00		1.00	1.00		1.00	1.00		1.00	1.00	
Frpb, ped/bikes	1.00	1.00		1.00	0.99		1.00	0.99		1.00	1.00	
Flpb, ped/bikes	1.00	1.00		1.00	1.00		1.00	1.00		0.99	1.00	
Frt	1.00	0.98		1.00	0.98		1.00	0.97		1.00	0.96	
Flt Protected	0.95	1.00		0.95	1.00		0.95	1.00		0.95	1.00	
Satd. Flow (prot)	1596	1645		1661	1638		1646	1632		1606	1626	
Flt Permitted	0.26	1.00		0.37	1.00		0.39	1.00		0.50	1.00	
Satd. Flow (perm)	443	1645		643	1638		675	1632		844	1626	
Peak-hour factor, PHF	0.94	0.94	0.94	0.94	0.94	0.94	0.94	0.94	0.94	0.94	0.94	0.94
Adj. Flow (vph)	170	430	83	53	377	66	83	176	37	78	190	74
RTOR Reduction (vph)	0	7	0	0	8	0	0	8	0	0	15	0
Lane Group Flow (vph)	170	506	0	53	435	0	83	205	0	78	249	0
Confl. Peds. (#/hr)	11		4	4		11			9	9		
Heavy Vehicles (%)	4%	4%	0%	0%	4%	3%	1%	4%	3%	3%	2%	6%
Turn Type	pm+pt	NA		pm+pt	NA		pm+pt	NA		pm+pt	NA	
Protected Phases	5	2		1	6		3	8		7	4	
Permitted Phases	2			6			8			4		
Actuated Green, G (s)	41.9	33.6		31.2	27.9		19.3	15.6		19.3	15.6	
Effective Green, g (s)	41.9	33.6		31.2	27.9		19.3	15.6		19.3	15.6	
Actuated g/C Ratio	0.55	0.44		0.41	0.37		0.25	0.20		0.25	0.20	
Clearance Time (s)	5.0	5.0		5.0	5.0		5.0	5.0		5.0	5.0	
Vehicle Extension (s)	2.0	3.0		2.0	4.0		2.0	2.0		2.0	2.0	
Lane Grp Cap (vph)	379	725		307	599		218	334		250	332	
v/s Ratio Prot	c0.05	c0.31		0.01	0.27		c0.02	0.13		0.02	c0.15	
v/s Ratio Perm	0.19			0.06			0.08			0.06		
v/c Ratio	0.45	0.70		0.17	0.73		0.38	0.61		0.31	0.75	
Uniform Delay, d1	10.7	17.2		14.0	20.9		22.6	27.6		22.4	28.5	
Progression Factor	1.00	1.00		1.00	1.00		1.00	1.00		1.00	1.00	
Incremental Delay, d2	0.3	2.9		0.1	4.7		0.4	2.4		0.3	7.9	
Delay (s)	11.0	20.1		14.1	25.5		23.0	29.9		22.7	36.4	
Level of Service	B	C		B	C		C	C		C	D	
Approach Delay (s)		17.9			24.3			28.0			33.2	
Approach LOS		B			C			C			C	
Intersection Summary												
HCM 2000 Control Delay			24.2				HCM 2000 Level of Service				C	
HCM 2000 Volume to Capacity ratio			0.70									
Actuated Cycle Length (s)			76.2				Sum of lost time (s)			20.0		
Intersection Capacity Utilization			70.3%				ICU Level of Service			C		
Analysis Period (min)			15									
c Critical Lane Group												

Queues
8: N Elm St & US 26

3/29/13

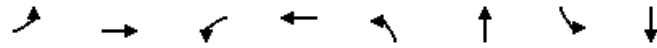





















Lane Group	EBL	EBT	WBL	WBT	NBL	NBT	SBL	SBT
Lane Group Flow (vph)	13	614	7	496	25	66	100	47
v/c Ratio	0.03	0.57	0.02	0.47	0.10	0.18	0.36	0.12
Control Delay	6.3	10.4	6.3	8.8	16.1	9.4	19.7	12.2
Queue Delay	0.0	0.0	0.0	0.0	0.0	0.0	0.0	0.0
Total Delay	6.3	10.4	6.3	8.8	16.1	9.4	19.7	12.2
Queue Length 50th (ft)	1	85	1	62	4	4	19	6
Queue Length 95th (ft)	10	280	7	204	24	32	68	31
Internal Link Dist (ft)		1205		1506		316		433
Turn Bay Length (ft)	75		75		50		50	
Base Capacity (vph)	660	1707	624	1690	618	844	663	900
Starvation Cap Reductn	0	0	0	0	0	0	0	0
Spillback Cap Reductn	0	0	0	0	0	0	0	0
Storage Cap Reductn	0	0	0	0	0	0	0	0
Reduced v/c Ratio	0.02	0.36	0.01	0.29	0.04	0.08	0.15	0.05

Intersection Summary

HCM Signalized Intersection Capacity Analysis

8: N Elm St & US 26

3/29/13

												
Movement	EBL	EBT	EBR	WBL	WBT	WBR	NBL	NBT	NBR	SBL	SBT	SBR
Lane Configurations												
Volume (vph)	12	536	11	6	427	14	22	20	39	89	28	14
Ideal Flow (vphpl)	1750	1750	1750	1750	1750	1750	1750	1750	1750	1750	1750	1750
Total Lost time (s)	5.0	5.0		5.0	5.0		5.0	5.0		5.0	5.0	
Lane Util. Factor	1.00	1.00		1.00	1.00		1.00	1.00		1.00	1.00	
Frbp, ped/bikes	1.00	1.00		1.00	1.00		1.00	0.98		1.00	0.99	
Flpb, ped/bikes	0.99	1.00		1.00	1.00		0.99	1.00		0.99	1.00	
Frt	1.00	1.00		1.00	1.00		1.00	0.90		1.00	0.95	
Flt Protected	0.95	1.00		0.95	1.00		0.95	1.00		0.95	1.00	
Satd. Flow (prot)	1414	1708		1659	1691		1507	1520		1633	1642	
Flt Permitted	0.45	1.00		0.36	1.00		0.73	1.00		0.71	1.00	
Satd. Flow (perm)	664	1708		625	1691		1152	1520		1228	1642	
Peak-hour factor, PHF	0.89	0.89	0.89	0.89	0.89	0.89	0.89	0.89	0.89	0.89	0.89	0.89
Adj. Flow (vph)	13	602	12	7	480	16	25	22	44	100	31	16
RTOR Reduction (vph)	0	1	0	0	2	0	0	36	0	0	13	0
Lane Group Flow (vph)	13	613	0	7	494	0	25	30	0	100	34	0
Confl. Peds. (#/hr)	10		5	5		10	12		8	8		12
Confl. Bikes (#/hr)												1
Heavy Vehicles (%)	17%	2%	9%	0%	3%	0%	9%	5%	0%	1%	0%	0%
Turn Type	Perm	NA		Perm	NA		Perm	NA		Perm	NA	
Protected Phases		2			6			8				4
Permitted Phases	2			6			8			4		
Actuated Green, G (s)	25.8	25.8		25.8	25.8		8.2	8.2		8.2	8.2	
Effective Green, g (s)	25.8	25.8		25.8	25.8		8.2	8.2		8.2	8.2	
Actuated g/C Ratio	0.59	0.59		0.59	0.59		0.19	0.19		0.19	0.19	
Clearance Time (s)	5.0	5.0		5.0	5.0		5.0	5.0		5.0	5.0	
Vehicle Extension (s)	3.5	3.5		3.5	3.5		2.5	2.5		2.5	2.5	
Lane Grp Cap (vph)	389	1001		366	991		214	283		228	306	
v/s Ratio Prot		c0.36			0.29			0.02				0.02
v/s Ratio Perm	0.02			0.01			0.02			c0.08		
v/c Ratio	0.03	0.61		0.02	0.50		0.12	0.11		0.44	0.11	
Uniform Delay, d1	3.8	5.9		3.8	5.3		14.9	14.9		15.9	14.9	
Progression Factor	1.00	1.00		1.00	1.00		1.00	1.00		1.00	1.00	
Incremental Delay, d2	0.0	1.2		0.0	0.5		0.2	0.1		1.0	0.1	
Delay (s)	3.9	7.0		3.8	5.8		15.1	15.0		16.8	15.0	
Level of Service	A	A		A	A		B	B		B	B	
Approach Delay (s)		7.0			5.8			15.0			16.3	
Approach LOS		A			A			B			B	

Intersection Summary







HCM 2000 Control Delay	8.1	HCM 2000 Level of Service	A
HCM 2000 Volume to Capacity ratio	0.57		
Actuated Cycle Length (s)	44.0	Sum of lost time (s)	10.0
Intersection Capacity Utilization	53.5%	ICU Level of Service	A
Analysis Period (min)	15		

c Critical Lane Group

Queues

9: S Combs Flat Rd & US 26



















3/29/13

						
Lane Group	EBL	EBT	WBL	WBT	NBT	SBT
Lane Group Flow (vph)	35	525	59	354	193	184
v/c Ratio	0.20	0.70	0.29	0.41	0.57	0.47
Control Delay	39.4	21.0	38.8	13.3	31.4	28.4
Queue Delay	0.0	0.0	0.0	0.0	0.0	0.0
Total Delay	39.4	21.0	38.8	13.3	31.4	28.4
Queue Length 50th (ft)	14	170	24	62	68	65
Queue Length 95th (ft)	54	371	80	219	177	165
Internal Link Dist (ft)		1816		4182	3042	696
Turn Bay Length (ft)	100		150			
Base Capacity (vph)	295	1333	295	1411	652	767
Starvation Cap Reductn	0	0	0	0	0	0
Spillback Cap Reductn	0	0	0	0	0	0
Storage Cap Reductn	0	0	0	0	0	0
Reduced v/c Ratio	0.12	0.39	0.20	0.25	0.30	0.24
Intersection Summary						

HCM Signalized Intersection Capacity Analysis

9: S Combs Flat Rd & US 26



















3/29/13

												
Movement	EBL	EBT	EBR	WBL	WBT	WBR	NBL	NBT	NBR	SBL	SBT	SBR
Lane Configurations												
Volume (vph)	33	348	146	55	307	25	70	68	44	33	113	27
Ideal Flow (vphpl)	1750	1750	1750	1750	1750	1750	1750	1750	1750	1750	1750	1750
Total Lost time (s)	5.0	5.0		5.0	5.0			5.0			5.0	
Lane Util. Factor	1.00	1.00		1.00	1.00			1.00			1.00	
Frbp, ped/bikes	1.00	0.99		1.00	1.00			1.00			1.00	
Flpb, ped/bikes	1.00	1.00		1.00	1.00			1.00			1.00	
Frt	1.00	0.96		1.00	0.99			0.97			0.98	
Flt Protected	0.95	1.00		0.95	1.00			0.98			0.99	
Satd. Flow (prot)	1599	1598		1599	1696			1575			1649	
Flt Permitted	0.95	1.00		0.95	1.00			0.81			0.92	
Satd. Flow (perm)	1599	1598		1599	1696			1296			1535	
Peak-hour factor, PHF	0.94	0.94	0.94	0.94	0.94	0.94	0.94	0.94	0.94	0.94	0.94	0.94
Adj. Flow (vph)	35	370	155	59	327	27	74	72	47	35	120	29
RTOR Reduction (vph)	0	16	0	0	3	0	0	11	0	0	6	0
Lane Group Flow (vph)	35	509	0	59	351	0	0	182	0	0	178	0
Confl. Peds. (#/hr)	2		1	1		2	3					3
Confl. Bikes (#/hr)		1			2			1				
Heavy Vehicles (%)	4%	4%	4%	4%	2%	0%	10%	4%	0%	3%	2%	4%
Turn Type	Prot	NA		Prot	NA		Perm	NA		Perm	NA	
Protected Phases	5	2		1	6			8			4	
Permitted Phases							8			4		
Actuated Green, G (s)	2.3	30.7		4.2	32.6			16.4			16.4	
Effective Green, g (s)	2.3	30.7		4.2	32.6			16.4			16.4	
Actuated g/C Ratio	0.03	0.46		0.06	0.49			0.25			0.25	
Clearance Time (s)	5.0	5.0		5.0	5.0			5.0			5.0	
Vehicle Extension (s)	2.0	4.5		2.5	4.5			2.8			2.8	
Lane Grp Cap (vph)	55	739		101	833			320			379	
v/s Ratio Prot	0.02	c0.32		c0.04	0.21							
v/s Ratio Perm								c0.14			0.12	
v/c Ratio	0.64	0.69		0.58	0.42			0.57			0.47	
Uniform Delay, d1	31.6	14.0		30.2	10.8			21.9			21.2	
Progression Factor	1.00	1.00		1.00	1.00			1.00			1.00	
Incremental Delay, d2	16.3	3.2		7.0	0.6			2.3			0.8	
Delay (s)	47.9	17.2		37.2	11.4			24.1			22.1	
Level of Service	D	B		D	B			C			C	
Approach Delay (s)		19.1			15.1			24.1			22.1	
Approach LOS		B			B			C			C	
Intersection Summary												
HCM 2000 Control Delay			19.0			HCM 2000 Level of Service			B			
HCM 2000 Volume to Capacity ratio			0.64									
Actuated Cycle Length (s)			66.3			Sum of lost time (s)		15.0				
Intersection Capacity Utilization			66.6%			ICU Level of Service			C			
Analysis Period (min)			15									

c Critical Lane Group

HCM Unsignalized Intersection Capacity Analysis
 10: NE Laughlin Rd & US 26

















3/29/13

												
Movement	EBL	EBT	EBR	WBL	WBT	WBR	NBL	NBT	NBR	SBL	SBT	SBR
Lane Configurations												
Volume (veh/h)	5	170	21	1	163	50	20	10	3	80	6	13
Sign Control	Free		Free		Free		Stop		Stop		Stop	
Grade	0%		0%		0%		0%		0%		0%	
Peak Hour Factor	0.89	0.89	0.89	0.89	0.89	0.89	0.89	0.89	0.89	0.89	0.89	0.89
Hourly flow rate (vph)	6	191	24	1	183	56	22	11	3	90	7	15
Pedestrians												1
Lane Width (ft)												12.0
Walking Speed (ft/s)												4.0
Percent Blockage												0
Right turn flare (veh)												
Median type	TWLTL				None							
Median storage (veh)	2											
Upstream signal (ft)												
pX, platoon unblocked												
vC, conflicting volume	184			215			417	400	203	426	440	212
vC1, stage 1 conf vol							214	214			214	214
vC2, stage 2 conf vol							203	186			211	226
vCu, unblocked vol	184			215			417	400	203	426	440	212
tC, single (s)	4.1			4.1			7.1	6.5	6.2	7.2	6.5	6.2
tC, 2 stage (s)							6.1	5.5			6.2	5.5
tF (s)	2.2			2.2			3.5	4.0	3.3	3.6	4.0	3.3
p0 queue free %	100			100			97	98	100	86	99	98
cM capacity (veh/h)	1402			1367			683	653	843	655	636	832
Direction, Lane #	EB 1	EB 2	WB 1	WB 2	NB 1	SB 1						
Volume Total	6	215	1	239	37	111						
Volume Left	6	0	1	0	22	90						
Volume Right	0	24	0	56	3	15						
cSH	1402	1700	1367	1700	685	672						
Volume to Capacity	0.00	0.13	0.00	0.14	0.05	0.17						
Queue Length 95th (ft)	0	0	0	0	4	15						
Control Delay (s)	7.6	0.0	7.6	0.0	10.6	11.4						
Lane LOS	A	A		B		B						
Approach Delay (s)	0.2	0.0		10.6		11.4						
Approach LOS	B		B		B							
Intersection Summary												
Average Delay			2.8									
Intersection Capacity Utilization			27.4%		ICU Level of Service				A			
Analysis Period (min)			15									

HCM Unsignalized Intersection Capacity Analysis



















11: Meadowlakes Dr & 2nd St

3/29/13

												
Movement	EBL	EBT	EBR	WBL	WBT	WBR	NBL	NBT	NBR	SBL	SBT	SBR
Lane Configurations												
Volume (veh/h)	5	107	11	33	19	7	1	18	36	13	16	7
Sign Control		Stop			Stop			Free			Free	
Grade		0%			0%			0%			0%	
Peak Hour Factor	0.83	0.83	0.83	0.83	0.83	0.83	0.83	0.83	0.83	0.83	0.83	0.83
Hourly flow rate (vph)	6	129	13	40	23	8	1	22	43	16	19	8
Pedestrians		10						1			6	
Lane Width (ft)		12.0						12.0			12.0	
Walking Speed (ft/s)		4.0						4.0			4.0	
Percent Blockage		1						0			1	
Right turn flare (veh)												
Median type								None			None	
Median storage (veh)												
Upstream signal (ft)												
pX, platoon unblocked												
vC, conflicting volume	136	132	34	179	115	49	38			65		
vC1, stage 1 conf vol												
vC2, stage 2 conf vol												
vCu, unblocked vol	136	132	34	179	115	49	38			65		
tC, single (s)	7.1	6.5	6.2	7.1	6.5	6.2	4.1			4.2		
tC, 2 stage (s)												
tF (s)	3.5	4.0	3.3	3.5	4.0	3.3	2.2			2.3		
p0 queue free %	99	83	99	94	97	99	100			99		
cM capacity (veh/h)	791	738	1035	657	764	1020	1572			1500		
Direction, Lane #	EB 1	WB 1	NB 1	SB 1								
Volume Total	148	71	66	43								
Volume Left	6	40	1	16								
Volume Right	13	8	43	8								
cSH	760	720	1572	1500								
Volume to Capacity	0.20	0.10	0.00	0.01								
Queue Length 95th (ft)	19	9	0	1								
Control Delay (s)	10.9	10.5	0.1	2.7								
Lane LOS	B	B	A	A								
Approach Delay (s)	10.9	10.5	0.1	2.7								
Approach LOS	B	B										
Intersection Summary												
Average Delay			7.6									
Intersection Capacity Utilization			27.7%		ICU Level of Service					A		
Analysis Period (min)			15									

HCM Unsignalized Intersection Capacity Analysis
 12: NW Deer St & 2nd St



















3/29/13

												
Movement	EBL	EBT	EBR	WBL	WBT	WBR	NBL	NBT	NBR	SBL	SBT	SBR
Lane Configurations												
Volume (veh/h)	23	82	79	3	55	59	32	65	1	9	52	14
Sign Control		Stop			Stop			Free			Free	
Grade		0%			0%			0%			0%	
Peak Hour Factor	0.84	0.84	0.84	0.84	0.84	0.84	0.84	0.84	0.84	0.84	0.84	0.84
Hourly flow rate (vph)	27	98	94	4	65	70	38	77	1	11	62	17
Pedestrians		4			7			2			1	
Lane Width (ft)		12.0			12.0			12.0			12.0	
Walking Speed (ft/s)		4.0			4.0			4.0			4.0	
Percent Blockage		0			1			0			0	
Right turn flare (veh)												
Median type								None			None	
Median storage (veh)												
Upstream signal (ft)											313	
pX, platoon unblocked												
vC, conflicting volume	353	257	76	389	265	86	83			86		
vC1, stage 1 conf vol												
vC2, stage 2 conf vol												
vCu, unblocked vol	353	257	76	389	265	86	83			86		
tC, single (s)	7.1	6.5	6.2	7.1	6.5	6.2	4.1			4.2		
tC, 2 stage (s)												
tF (s)	3.5	4.0	3.3	3.5	4.0	3.3	2.2			2.3		
p0 queue free %	94	84	90	99	89	93	97			99		
cM capacity (veh/h)	492	622	983	439	617	966	1503			1447		
Direction, Lane #	EB 1	WB 1	NB 1	NB 2	SB 1	SB 2						
Volume Total	219	139	38	79	11	79						
Volume Left	27	4	38	0	11	0						
Volume Right	94	70	0	1	0	17						
cSH	710	745	1503	1700	1447	1700						
Volume to Capacity	0.31	0.19	0.03	0.05	0.01	0.05						
Queue Length 95th (ft)	34	18	2	0	1	0						
Control Delay (s)	12.3	10.9	7.5	0.0	7.5	0.0						
Lane LOS	B	B	A		A							
Approach Delay (s)	12.3	10.9	2.4		0.9							
Approach LOS	B	B										
Intersection Summary												
Average Delay			8.1									
Intersection Capacity Utilization			34.3%		ICU Level of Service					A		
Analysis Period (min)			15									

HCM Unsignalized Intersection Capacity Analysis



















13: Main St & 2nd St

3/29/13

												
Movement	EBL	EBT	EBR	WBL	WBT	WBR	NBL	NBT	NBR	SBL	SBT	SBR
Lane Configurations												
Volume (veh/h)	9	22	83	3	22	40	66	208	7	17	252	33
Sign Control		Stop			Stop			Free			Free	
Grade		0%			0%			0%			0%	
Peak Hour Factor	0.90	0.90	0.90	0.90	0.90	0.90	0.90	0.90	0.90	0.90	0.90	0.90
Hourly flow rate (vph)	10	24	92	3	24	44	73	231	8	19	280	37
Pedestrians		11			5			2			11	
Lane Width (ft)		12.0			12.0			12.0			12.0	
Walking Speed (ft/s)		4.0			4.0			4.0			4.0	
Percent Blockage		1			0			0			1	
Right turn flare (veh)												
Median type								None			None	
Median storage (veh)												
Upstream signal (ft)											319	
pX, platoon unblocked	0.93	0.93	0.93	0.93	0.93		0.93					
vC, conflicting volume	793	738	311	811	752	251	328			244		
vC1, stage 1 conf vol												
vC2, stage 2 conf vol												
vCu, unblocked vol	742	684	227	762	699	251	244			244		
tC, single (s)	7.1	6.5	6.2	7.1	6.5	6.2	4.1			4.1		
tC, 2 stage (s)												
tF (s)	3.5	4.0	3.3	3.5	4.0	3.3	2.2			2.2		
p0 queue free %	96	92	88	99	92	94	94			99		
cM capacity (veh/h)	254	319	753	232	308	782	1234			1329		
Direction, Lane #	EB 1	WB 1	NB 1	NB 2	SB 1	SB 2						
Volume Total	127	72	73	239	19	317						
Volume Left	10	3	73	0	19	0						
Volume Right	92	44	0	8	0	37						
cSH	531	479	1234	1700	1329	1700						
Volume to Capacity	0.24	0.15	0.06	0.14	0.01	0.19						
Queue Length 95th (ft)	24	14	5	0	1	0						
Control Delay (s)	13.9	13.8	8.1	0.0	7.7	0.0						
Lane LOS	B	B	A		A							
Approach Delay (s)	13.9	13.8	1.9		0.4							
Approach LOS	B	B										
Intersection Summary												
Average Delay			4.1									
Intersection Capacity Utilization			41.7%		ICU Level of Service					A		
Analysis Period (min)			15									

HCM Unsignalized Intersection Capacity Analysis
 14: Main St & SE Lynn Blvd

3/29/13

												
Movement	EBL	EBT	EBR	WBL	WBT	WBR	NBL	NBT	NBR	SBL	SBT	SBR
Lane Configurations												
Volume (veh/h)	36	12	1	7	8	219	2	14	6	192	32	3
Sign Control		Stop			Stop			Free			Free	
Grade		0%			0%			0%			0%	
Peak Hour Factor	0.74	0.74	0.74	0.74	0.74	0.74	0.74	0.74	0.74	0.74	0.74	0.74
Hourly flow rate (vph)	49	16	1	9	11	296	3	19	8	259	43	4
Pedestrians								4			1	
Lane Width (ft)								12.0			12.0	
Walking Speed (ft/s)								4.0			4.0	
Percent Blockage								0			0	
Right turn flare (veh)												
Median type								None			None	
Median storage (veh)												
Upstream signal (ft)												
pX, platoon unblocked												
vC, conflicting volume	895	597	49	604	595	24	47			27		
vC1, stage 1 conf vol												
vC2, stage 2 conf vol												
vCu, unblocked vol	895	597	49	604	595	24	47			27		
tC, single (s)	7.1	6.5	6.2	7.2	6.5	6.3	5.1			4.1		
tC, 2 stage (s)												
tF (s)	3.5	4.0	3.3	3.6	4.0	3.4	3.1			2.2		
p0 queue free %	70	95	100	97	97	71	100			84		
cM capacity (veh/h)	161	350	1022	330	351	1037	1108			1593		
Direction, Lane #	EB 1	WB 1	NB 1	SB 1	SB 2							
Volume Total	66	316	30	259	47							
Volume Left	49	9	3	259	0							
Volume Right	1	296	8	0	4							
cSH	189	917	1108	1593	1700							
Volume to Capacity	0.35	0.34	0.00	0.16	0.03							
Queue Length 95th (ft)	38	40	0	15	0							
Control Delay (s)	34.0	11.0	0.8	7.7	0.0							
Lane LOS	D	B	A	A								
Approach Delay (s)	34.0	11.0	0.8	6.5								
Approach LOS	D	B										
Intersection Summary												
Average Delay			10.8									
Intersection Capacity Utilization			48.3%		ICU Level of Service				A			
Analysis Period (min)			15									

HCM Unsignalized Intersection Capacity Analysis

15: S Combs Flat Rd & SE Lynn Blvd

3/29/13



Movement	EBL	EBR	NBL	NBT	SBT	SBR
Lane Configurations						
Volume (veh/h)	65	150	94	95	191	93
Sign Control	Stop			Free	Free	
Grade	0%			0%	0%	
Peak Hour Factor	0.85	0.85	0.85	0.85	0.85	0.85
Hourly flow rate (vph)	76	176	111	112	225	109
Pedestrians				4		
Lane Width (ft)				12.0		
Walking Speed (ft/s)				4.0		
Percent Blockage				0		
Right turn flare (veh)						
Median type				None	None	
Median storage (veh)						
Upstream signal (ft)						
pX, platoon unblocked						
vC, conflicting volume	612	283	334			
vC1, stage 1 conf vol						
vC2, stage 2 conf vol						
vCu, unblocked vol	612	283	334			
tC, single (s)	6.4	6.2	4.1			
tC, 2 stage (s)						
tF (s)	3.5	3.3	2.2			
p0 queue free %	81	76	91			
cM capacity (veh/h)	412	746	1209			
Direction, Lane #	EB 1	NB 1	SB 1			
Volume Total	253	222	334			
Volume Left	76	111	0			
Volume Right	176	0	109			
cSH	599	1209	1700			
Volume to Capacity	0.42	0.09	0.20			
Queue Length 95th (ft)	54	8	0			
Control Delay (s)	15.3	4.5	0.0			
Lane LOS	C	A				
Approach Delay (s)	15.3	4.5	0.0			
Approach LOS	C					
Intersection Summary						
Average Delay			6.0			
Intersection Capacity Utilization			52.4%	ICU Level of Service	A	
Analysis Period (min)			15			

HCM Unsignalized Intersection Capacity Analysis

16: OR126 (WB) & US 26/US 26 (WB)

3/29/13



Movement	EBT	EBR	WBL	WBT	NBL	NBR
Lane Configurations				↑	↑	
Volume (veh/h)	0	0	0	626	144	0
Sign Control	Free			Free	Stop	
Grade	0%			0%	0%	
Peak Hour Factor	0.94	0.94	0.94	0.94	0.94	0.94
Hourly flow rate (vph)	0	0	0	666	153	0
Pedestrians						
Lane Width (ft)						
Walking Speed (ft/s)						
Percent Blockage						
Right turn flare (veh)						
Median type	None			None		
Median storage (veh)						
Upstream signal (ft)						
pX, platoon unblocked						
vC, conflicting volume	0			666	0	
vC1, stage 1 conf vol						
vC2, stage 2 conf vol						
vCu, unblocked vol	0			666	0	
tC, single (s)	4.1			6.5	6.2	
tC, 2 stage (s)						
tF (s)	2.2			3.6	3.3	
p0 queue free %	100			62	100	
cM capacity (veh/h)	1604			405	1091	
Direction, Lane #						
	WB 1	NB 1				
Volume Total	666	153				
Volume Left	0	153				
Volume Right	0	0				
cSH	1700	405				
Volume to Capacity	0.39	0.38				
Queue Length 95th (ft)	0	45				
Control Delay (s)	0.0	19.2				
Lane LOS		C				
Approach Delay (s)	0.0	19.2				
Approach LOS		C				
Intersection Summary						
Average Delay	3.6					
Intersection Capacity Utilization	87.1%			ICU Level of Service	E	
Analysis Period (min)	15					

HCM Unsignalized Intersection Capacity Analysis
 17: OR 126 (EB)/OR 126 & US 26 (EB)



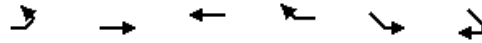











3/29/13



Movement	EBL	EBT	WBT	WBR	SEL	SER
Lane Configurations		↑			↓	
Volume (veh/h)	0	799	0	0	107	0
Sign Control		Free	Free		Yield	
Grade		0%	0%		0%	
Peak Hour Factor	0.94	0.94	0.94	0.94	0.94	0.94
Hourly flow rate (vph)	0	850	0	0	114	0
Pedestrians						
Lane Width (ft)						
Walking Speed (ft/s)						
Percent Blockage						
Right turn flare (veh)						
Median type		None	None			
Median storage (veh)						
Upstream signal (ft)						
pX, platoon unblocked						
vC, conflicting volume	0				850	0
vC1, stage 1 conf vol						
vC2, stage 2 conf vol						
vCu, unblocked vol	0				850	0
tC, single (s)	4.1				6.4	6.2
tC, 2 stage (s)						
tF (s)	2.2				3.5	3.3
p0 queue free %	100				65	100
cM capacity (veh/h)	1636				328	1091
Direction, Lane #						
	EB 1	SE 1				
Volume Total	850	114				
Volume Left	0	114				
Volume Right	0	0				
cSH	1700	328				
Volume to Capacity	0.50	0.35				
Queue Length 95th (ft)	0	39				
Control Delay (s)	0.0	21.7				
Lane LOS		C				
Approach Delay (s)	0.0	21.7				
Approach LOS		C				
Intersection Summary						
Average Delay			2.6			
Intersection Capacity Utilization			54.6%		ICU Level of Service	A
Analysis Period (min)			15			

HCM Unsignalized Intersection Capacity Analysis
 18: US 26 (EB) & OR 126/OR 126 (WB)

3/29/13

													
Movement	EBL	EBT	EBR	WBL	WBT	WBR	NBL	NBT	NBR	SBL	SBT	SBR	
Lane Configurations													
Volume (veh/h)	0	0	0	0	480	0	0	0	0	0	107	0	
Sign Control	Free			Free			Stop			Stop			
Grade	0%			0%			0%			0%			
Peak Hour Factor	0.94	0.94	0.94	0.94	0.94	0.94	0.94	0.94	0.94	0.94	0.94	0.94	
Hourly flow rate (vph)	0	0	0	0	511	0	0	0	0	0	114	0	
Pedestrians													
Lane Width (ft)													
Walking Speed (ft/s)													
Percent Blockage													
Right turn flare (veh)													
Median type	None			None									
Median storage (veh)													
Upstream signal (ft)													
pX, platoon unblocked													
vC, conflicting volume	511	0			568			511	0	511	511	511	
vC1, stage 1 conf vol													
vC2, stage 2 conf vol													
vCu, unblocked vol	511	0			568			511	0	511	511	511	
tC, single (s)	4.1	4.1			7.1			6.5	6.2	7.1	6.5	6.2	
tC, 2 stage (s)													
tF (s)	2.2	2.2			3.5			4.0	3.3	3.5	4.0	3.3	
p0 queue free %	100	100			100			100	100	100	75	100	
cM capacity (veh/h)	1065	1636			354			469	1091	477	463	567	
Direction, Lane #	WB 1	SB 1											
Volume Total	511	114											
Volume Left	0	0											
Volume Right	0	0											
cSH	1700	463											
Volume to Capacity	0.30	0.25											
Queue Length 95th (ft)	0	25											
Control Delay (s)	0.0	15.3											
Lane LOS	C												
Approach Delay (s)	0.0	15.3											
Approach LOS	C												
Intersection Summary													
Average Delay	2.8												
Intersection Capacity Utilization	37.6%			ICU Level of Service					A				
Analysis Period (min)	15												

HCM Unsignalized Intersection Capacity Analysis
 19: OR 126 & O'Neil Hwy

3/29/13

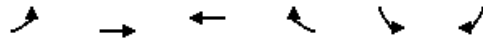











Movement	EBL	EBT	WBT	WBR	SBL	SBR
Lane Configurations	↔	↑	↕↔		↔	
Volume (veh/h)	11	630	497	122	80	6
Sign Control		Free	Free		Stop	
Grade		0%	0%		0%	
Peak Hour Factor	0.91	0.91	0.91	0.91	0.91	0.91
Hourly flow rate (vph)	12	692	546	134	88	7
Pedestrians						
Lane Width (ft)						
Walking Speed (ft/s)						
Percent Blockage						
Right turn flare (veh)						
Median type		TWLTL	None			
Median storage (veh)		2				
Upstream signal (ft)						
pX, platoon unblocked						
vC, conflicting volume	680				1330	340
vC1, stage 1 conf vol					613	
vC2, stage 2 conf vol					716	
vCu, unblocked vol	680				1330	340
tC, single (s)	4.8				6.9	6.9
tC, 2 stage (s)					5.9	
tF (s)	2.6				3.5	3.3
p0 queue free %	98				74	99
cM capacity (veh/h)	713				343	662
Direction, Lane #	EB 1	EB 2	WB 1	WB 2	SB 1	
Volume Total	12	692	364	316	95	
Volume Left	12	0	0	0	88	
Volume Right	0	0	0	134	7	
cSH	713	1700	1700	1700	355	
Volume to Capacity	0.02	0.41	0.21	0.19	0.27	
Queue Length 95th (ft)	1	0	0	0	27	
Control Delay (s)	10.1	0.0	0.0	0.0	18.8	
Lane LOS	B				C	
Approach Delay (s)	0.2		0.0		18.8	
Approach LOS					C	
Intersection Summary						
Average Delay			1.3			
Intersection Capacity Utilization			44.6%		ICU Level of Service	A
Analysis Period (min)			15			

HCM Unsignalized Intersection Capacity Analysis

20: OR 126 & Rimrock Rd





















3/29/13

						
Movement	WBL	WBR	NBT	NBR	SBL	SBT
Lane Configurations						
Volume (veh/h)	2	33	623	10	50	445
Sign Control	Stop		Free			Free
Grade	0%		0%			0%
Peak Hour Factor	0.93	0.93	0.93	0.93	0.93	0.93
Hourly flow rate (vph)	2	35	670	11	54	478
Pedestrians						
Lane Width (ft)						
Walking Speed (ft/s)						
Percent Blockage						
Right turn flare (veh)						
Median type	None			TWLTL		
Median storage (veh)	2					
Upstream signal (ft)						
pX, platoon unblocked						
vC, conflicting volume	1017	670			681	
vC1, stage 1 conf vol	670					
vC2, stage 2 conf vol	347					
vCu, unblocked vol	1017	670			681	
tC, single (s)	6.8	7.1			4.3	
tC, 2 stage (s)	5.8					
tF (s)	3.5	3.4			2.3	
p0 queue free %	99	91			94	
cM capacity (veh/h)	420	383			869	
Direction, Lane #	WB 1	NB 1	NB 2	SB 1	SB 2	SB 3
Volume Total	38	670	11	54	239	239
Volume Left	2	0	0	54	0	0
Volume Right	35	0	11	0	0	0
cSH	385	1700	1700	869	1700	1700
Volume to Capacity	0.10	0.39	0.01	0.06	0.14	0.14
Queue Length 95th (ft)	8	0	0	5	0	0
Control Delay (s)	15.3	0.0	0.0	9.4	0.0	0.0
Lane LOS	C			A		
Approach Delay (s)	15.3	0.0		1.0		
Approach LOS	C					
Intersection Summary						
Average Delay			0.9			
Intersection Capacity Utilization			52.3%	ICU Level of Service	A	
Analysis Period (min)			15			

HCM Unsignalized Intersection Capacity Analysis

21: Tom McCall Rd & OR 126





















3/29/13

												
Movement	EBL	EBT	EBR	WBL	WBT	WBR	NBL	NBT	NBR	SBL	SBT	SBR
Lane Configurations												
Volume (veh/h)	12	518	1	24	381	38	14	9	72	66	7	44
Sign Control		Free			Free			Stop			Stop	
Grade		0%			0%			0%			0%	
Peak Hour Factor	0.79	0.79	0.79	0.79	0.79	0.79	0.79	0.79	0.79	0.79	0.79	0.79
Hourly flow rate (vph)	15	656	1	30	482	48	18	11	91	84	9	56
Pedestrians												
Lane Width (ft)												
Walking Speed (ft/s)												
Percent Blockage												
Right turn flare (veh)									2			2
Median type		None			None							
Median storage (veh)												
Upstream signal (ft)												
pX, platoon unblocked												
vC, conflicting volume	530			657			1261	1277	656	1280	1230	482
vC1, stage 1 conf vol												
vC2, stage 2 conf vol												
vCu, unblocked vol	530			657			1261	1277	656	1280	1230	482
tC, single (s)	4.3			4.3			7.2	6.8	6.3	7.3	6.6	6.3
tC, 2 stage (s)												
tF (s)	2.4			2.4			3.6	4.3	3.4	3.7	4.1	3.4
p0 queue free %	98			96			85	92	80	12	94	90
cM capacity (veh/h)	965			863			119	137	452	95	160	574
Direction, Lane #	EB 1	EB 2	WB 1	WB 2	NB 1	SB 1						
Volume Total	671	1	513	48	120	148						
Volume Left	15	0	30	0	18	84						
Volume Right	0	1	0	48	91	56						
cSH	965	1700	863	1700	522	152						
Volume to Capacity	0.02	0.00	0.04	0.03	0.23	0.98						
Queue Length 95th (ft)	1	0	3	0	23	188						
Control Delay (s)	0.4	0.0	1.0	0.0	21.5	125.9						
Lane LOS	A		A		C	F						
Approach Delay (s)	0.4		0.9		21.5	125.9						
Approach LOS					C	F						
Intersection Summary												
Average Delay			14.7									
Intersection Capacity Utilization			57.1%		ICU Level of Service				B			
Analysis Period (min)			15									

HCM Unsignalized Intersection Capacity Analysis

22: Millican Rd/Airport Way & OR 126

3/29/13

												
Movement	EBL	EBT	EBR	WBL	WBT	WBR	NBL	NBT	NBR	SBL	SBT	SBR
Lane Configurations												
Volume (veh/h)	3	480	11	37	390	3	12	1	69	3	2	5
Sign Control		Free			Free			Stop			Stop	
Grade		0%			0%			0%			0%	
Peak Hour Factor	0.83	0.83	0.83	0.83	0.83	0.83	0.83	0.83	0.83	0.83	0.83	0.83
Hourly flow rate (vph)	4	578	13	45	470	4	14	1	83	4	2	6
Pedestrians												
Lane Width (ft)												
Walking Speed (ft/s)												
Percent Blockage												
Right turn flare (veh)												
Median type		None			None							
Median storage (veh)												
Upstream signal (ft)												
pX, platoon unblocked												
vC, conflicting volume	473			592			1152	1148	578	1228	1158	470
vC1, stage 1 conf vol												
vC2, stage 2 conf vol												
vCu, unblocked vol	473			592			1152	1148	578	1228	1158	470
tC, single (s)	4.4			4.4			7.3	6.5	6.4	7.4	7.0	6.3
tC, 2 stage (s)												
tF (s)	2.5			2.4			3.7	4.0	3.4	3.8	4.5	3.4
p0 queue free %	100			95			91	99	83	97	98	99
cM capacity (veh/h)	945			873			153	189	490	106	151	574
Direction, Lane #	EB 1	EB 2	EB 3	WB 1	WB 2	WB 3	NB 1	SB 1				
Volume Total	4	578	13	45	470	4	99	12				
Volume Left	4	0	0	45	0	0	14	4				
Volume Right	0	0	13	0	0	4	83	6				
cSH	945	1700	1700	873	1700	1700	365	199				
Volume to Capacity	0.00	0.34	0.01	0.05	0.28	0.00	0.27	0.06				
Queue Length 95th (ft)	0	0	0	4	0	0	28	5				
Control Delay (s)	8.8	0.0	0.0	9.3	0.0	0.0	18.5	24.2				
Lane LOS	A			A			C	C				
Approach Delay (s)	0.1			0.8			18.5	24.2				
Approach LOS							C	C				
Intersection Summary												
Average Delay			2.1									
Intersection Capacity Utilization			46.1%		ICU Level of Service			A				
Analysis Period (min)			15									

APPENDIX D – ACTIVE TRANSPORTATION MAPS

Safe Routes Segment Map



Safe Routes Schools

Safe Routes Segment

- 1
- 2
- 3
- 4
- 5
- 6
- 7



CRACK COUNTY MAKES NO WARRANTY OF ANY KIND, EXPRESSED OR IMPLIED, AS TO THE ACCURACY, COMPLETENESS, RELIABILITY, FITNESS FOR A PARTICULAR PURPOSE, OR ANY OTHER MATTER, IN ANY MANNER, FOR ANY PURPOSES, INCLUDING BUT NOT LIMITED TO, THE USE OF THE INFORMATION FOR ANY PURPOSES. THE INFORMATION IS PROVIDED FOR INFORMATIONAL PURPOSES ONLY AND DOES NOT CONSTITUTE A PROFESSIONAL ENGINEERING SURVEY OR ENGINEERING PURPOSES OR THE AUTHORITATIVE AND/OR OFFICIAL STATUS OF ANY APPARENT ROUTE OF ACCESS IDENTIFIED IN DIGITAL OR ANALOG FORM. CRACK COUNTY ASSOCIATES, INC. MAKES NO WARRANTY AS TO THE ACCURACY, COMPLETENESS, RELIABILITY, FITNESS FOR A PARTICULAR PURPOSE, OR ANY OTHER MATTER, IN ANY MANNER, FOR ANY PURPOSES, INCLUDING BUT NOT LIMITED TO, THE USE OF THE INFORMATION FOR ANY PURPOSES. CRACK COUNTY ASSOCIATES, INC. MAKES NO WARRANTY AS TO THE ACCURACY, COMPLETENESS, RELIABILITY, FITNESS FOR A PARTICULAR PURPOSE, OR ANY OTHER MATTER, IN ANY MANNER, FOR ANY PURPOSES, INCLUDING BUT NOT LIMITED TO, THE USE OF THE INFORMATION FOR ANY PURPOSES.

APPENDIX E – CRASH ANALYSIS INFORMATION

The following pages present the supplement information regarding the crash analysis conducted as part of the Prineville TSP existing conditions analysis.

Crash Rate Calculations

Segment crash rates are calculated by ODOT on an annual basis, as summarized in the *Crash Rate Book*. Crash rates were calculated for intersections on ODOT facilities and Main Street. Intersection crash rates were compared to the critical crash rates calculated following procedures in the Highway Safety Manual, and statewide 90th percentile rates for similar facilities in urban areas, as documented in *Assessment of Statewide Intersection Safety Performance*, prepared for ODOT and FHWA. Segment and intersection crash rates are summarized in Table E-1 and Table E-3, respectively.

Table E-1 Roadway segment crash history (January 2009 – December 2011)

Highway	Segment	Mile Post	Crash Rates			Statewide Average ¹		
			2009	2010	2011	2009	2010	2011
US 26 (Madras Highway)	Western City Limits to Ochoco Highway (OR 126)	25.46 – 26.28	0.63	0.65	0.69	2.36	2.50	2.84
OR 126 (Ochoco Highway)	Western City Limit to O’Neil Highway (OR 370)	14.81 – 17.92	0.19	0.92	0.56	2.36	2.50	2.84
	O’Neil Highway (OR 370) to Main Street	17.92 – 18.75	1.28	3.32	3.86	2.36	2.50	2.84
	Main Street to Paulina Highway (OR 380)	18.75 – 19.75	2.67	4.14	5.16	2.36	2.50	2.84
	Paulina Highway (OR 380) to Eastern City Limit	19.75 – 20.75	2.43	0.80	1.23	2.36	2.50	2.84
OR 370 (O’Neil Highway)	Western City Limit to Ochoco Highway (OR 126)	16.80 – 17.67	-	-	- ²	2.36	2.50	2.84
OR 380 (Paulina Highway)	Ochoco Highway (OR 126) to Southern City Limits	0.00 – 0.01	-	-	-	2.36	2.50	2.84

¹ Crash Rates were compared to statewide averages for Other Principal Arterials in Urban Cities.

² 2008 crash rate of 1.74 is the only recorded rate in last 5 years.

In 2010 and 2011 crash rates on OR 126 from OR 370 to OR 380 exceed statewide average crash rates.

Table E-2 Intersection Crash History (January 2007 – December 2011)

Intersection (Traffic Control)	Number of Crashes	Crash Type					Severity		
		Angle	Rear-End	Turning	Fixed-Object	Other	PDO ¹	Injury	Fatality
1. N Main St & NE 10th St	9	1	2	5	0	1	5	4	0
2. N Main St & NE 9th St	7	1	1	4	0	1	7	0	0
3. N Main St & NE 4th St	12	2	9	0	0	1	8	4	0
4. 3rd St/US 26 & NW 9th St	1	0	0	0	1	0	1	0	0
5. NW Hardwood Ave & 3rd St/US 26	14	0	11	3	0	0	6	8	0
6. NW Deer St & 3rd St/US 26	15	2	8	2	0	3	9	6	0
7. N Main St & 3rd St/US 26	21	2	14	5	0	0	15	6	0
8. N Elm St & 3rd St/US 26	14	0	11	1	0	2	5	9	0
9. NE Combs Flat Rd & 3rd St/US 26	18	2	7	7	1	1	11	7	0
10. NE Laughlin Rd & 3rd St/US26	0	0	0	0	0	0	0	0	0
11. NW Meadows Lakes Dr & N 2nd St	0	0	0	0	0	0	0	0	0
12. NW Deer St & N 2nd St	10	8	1	0	0	1	2	8	0
13. SE Main St & N 2nd St	4	1	1	1	0	1	4	0	0
14. SE Main St & SE Lynn Blvd	1	0	0	1	0	0	0	1	0
15. SE Combs Flat Rd & SE Lynn Blvd	2	0	0	2	0	0	1	1	0
16. WB OR 126 & WB US 26	1	0	1	0	0	0	0	1	0
17. EB OR 126 & EB US 26	0	0	0	0	0	0	0	0	0
18. WB OR 126 & EB US 26	0	0	0	0	0	0	0	0	0
19. O'Neil Hwy & OR 126	7	0	1	5	1	0	4	3	0
20. S Rimrock Rd & OR 126	3	0	0	0	2	1	2	1	0
21. Tom McCall Rd & OR 126	4	0	2	1	0	1	1	3	0
22. SW Millican Rd & OR 126	5	0	1	0	0	4	2	3	0

¹ PDO = Property damage only

Table E-3 Intersection Crash Rate Summary (January 2007 – December 2011)

Intersection	Number of Crashes	AADT ¹	Crash Rate (crashes per million entering vehicles)*	Critical Crash Rate (crashes per million entering vehicles)	Statewide 90 th Percentile Rate
1. N Main St & NE 10th St	9	10,500	0.47	0.95	0.86
2. N Main St & NE 9th St	7	11,700	0.33	0.44	0.29
3. N Main St & NE 4th St	12	9,200	0.71	0.47	0.41
4. 3rd St/US 26 & NW 9th St	1	5,700	0.10	0.54	0.29
5. NW Hardwood Ave & 3rd St/US 26	14	13,800	0.56	0.90	0.86
6. NW Deer St & 3rd St/US 26	15	13,500	0.61	0.91	0.86
7. N Main St & 3rd St/US 26	21	17,100	0.67	0.87	0.86
8. N Elm St & 3rd St/US 26	14	12,200	0.63	0.92	0.86
9. NE Combs Flat Rd & 3rd St/US 26	18	12,700	0.78	0.92	0.86
10. NE Laughlin Rd & 3rd St/US26	0	5,500	0.00	0.54	0.29
11. NW Meadows Lakes Dr & N 2nd St	0	2,700	0.00	0.70	0.41
12. NW Deer St & N 2nd St	10	4,700	1.17	0.57	0.41
13. SE Main St & N 2nd St	4	7,600	0.29	0.49	0.41
14. SE Main St & SE Lynn Blvd	1	5,300	0.10	0.55	0.41
15. SE Combs Flat Rd & SE Lynn Blvd	2	6,900	0.16	0.51	0.29
16. WB OR 126 & WB US 26	1	7,700	0.07	0.49	0.29
17. EB OR 126 & EB US 26	0	9,100	0.00	0.47	0.29
18. WB OR 126 & EB US 26	0	5,900	0.00	0.53	0.29
19. O'Neil Hwy & OR 126	7	13,500	0.28	0.42	0.29
20. S Rimrock Rd & OR 126	3	11,600	0.14	0.44	0.29
21. Tom McCall Rd & OR 126	4	11,900	0.18	0.44	0.41
22. SW Millican Rd & OR 126	5	10,200	0.27	0.45	0.41

¹ AADT = Average Annual Daily Traffic, estimated as ten times the peak hour entering volume.

* **BOLD TEXT** indicates crash rates that exceed critical crash rates or the statewide 90th percentile rates.

Three intersections are identified that have crash rates greater than the calculated critical crash rates and/or the 90th-percentile statewide crash rate. The intersections and factors that could contribute to crashes are provided below.

- *Main Street/N 9th Street* – Traffic control improvements are planned on Main Street at N 9th and 10th Street, which will change the crash patterns and reduce conflict points. No additional countermeasures were identified.
- *N Main Street/N 4th Street* – The majority of crashes at this intersection are rear-end crashes that resulted in property damage only. The proximity to the signalized Main Street/N 3rd Street intersection may result in queued vehicles through this intersection during peak hours.
- *N Deer Street/N 2nd Street* – eight of ten reported crashes were angle crashes. The east-west volume has increased since the 2nd Street connection to OR 126 was completed. Crash reports indicate that in all eight angle crashes the driver “did not yield to right-of-way” or “passed stop sign or red flasher.”

Statewide Priority Index System (SPIS)

The SPIS is a method developed by ODOT for ranking locations annually on state highways by considering crash frequency, crash rate, and crash severity. ODOT’s annual SPIS analysis uses the most-recent three years of crash data (i.e., 2012 SPIS sites are based on 2009 through 2011 crash data). The most-recent SPIS analysis was reviewed to determine if ODOT has identified any SPIS sites on state highways within the study area that are in the top 5 to 10 percent of all SPIS sites in the state.

A roadway segment is designated as a SPIS site if a location experiences three or more crashes or one or more fatal crashes over a three-year period. Under this method, all state highways are analyzed in 0.10 mile segments to identify SPIS sites. There are approximately 6,000 SPIS sites statewide. Segments identified in the top 5 of the SPIS will be reviewed in greater detail to identify opportunities to reduce frequency of crashes.

Based on information provided by ODOT, the following segments were identified in the top 5 or 10 percent of SPIS sites.

- A segment of US 26 (N 3rd Street) from Maple to Claypool (Milepost 18.43 to 18.61) was identified in the 2012 top 5-percent of all ODOT sites based on 2009 to 2011 crash data. This section of roadway has 7 private driveways on the south side and 3 on the north side (in addition to 2 public street accesses). Reducing driveway density or restricting movements at private driveways could reduce conflict points and potential for rear-end or angle crashes.
- A segment from Deer Street to Claypool (Milepost 18.53 to 18.64) was in the 2009 top 10-percent of all ODOT SPIS sites.

- A segment of US 26 at Harwood and a segment of US 26 at Combs Flat Road (Milepost 19.67 to 19.76) were identified in the top 10-percent of 2011 SPIS sites, based on 2008 to 2010 crash reports.

APPENDIX F – ACCESS MANAGEMENT STANDARDS

Providing highway access to other public roadways, land uses, and destinations is a critical part of an effective transportation system. However, it is necessary to balance access with the need for mobility and safety on the system as well. Providing access via other public streets and driveways to land uses creates points of friction from a traffic operations perspective thereby reducing mobility and introduces conflict points, which can increase the occurrence of crashes.

Access management strategies and implementation require careful consideration to balance the needs for access to developed land with the need to ensure movement of traffic in a safe and efficient manner. In general, access management is generally more stringent as the functional classification level of roadways increases and the corresponding importance of mobility increases. Exhibit F-1 illustrates the relationship between access and mobility relative to the street classifications in the Prineville urban area.

Exhibit F-1 Relationship between Access, Mobility, and Functional Classification

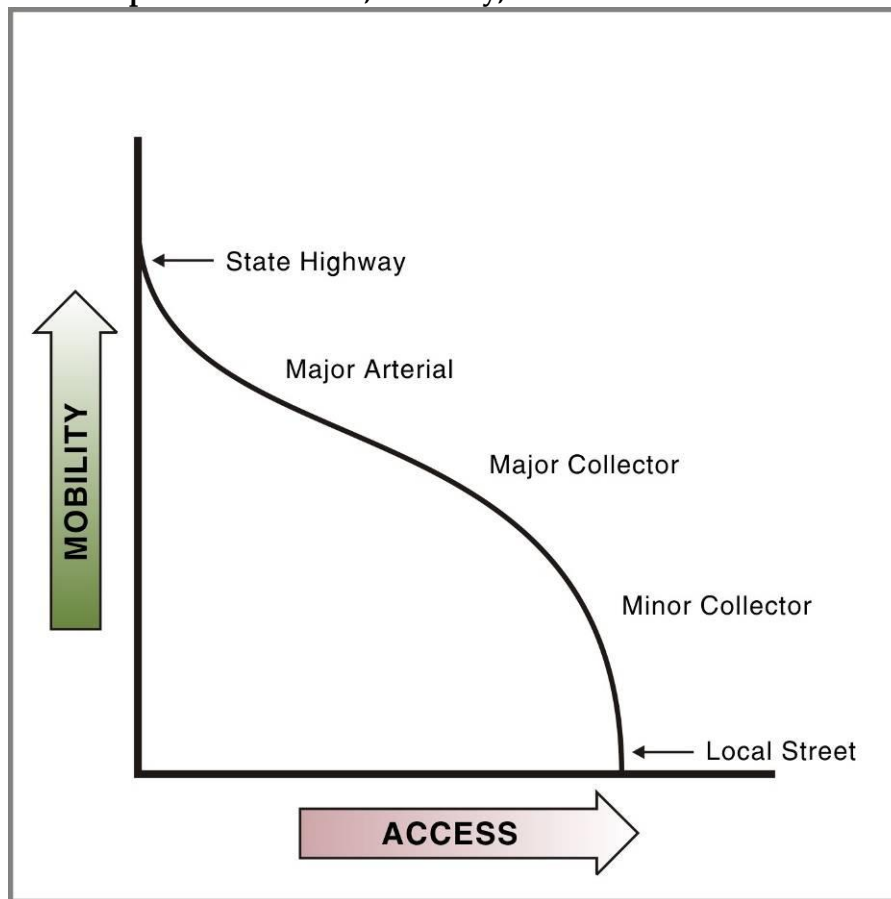

Examples of State Highway (Major Arterial), Arterial, Collector, and Local Street classified streets in Prineville are summarized in Technical Memorandum #3.

The City of Prineville, Crook County and ODOT have different access spacing standards. Access spacing standards for a specific roadway depend on the roadway's functional classification and

the jurisdictional responsibility (i.e., City, County, or State). The access spacing standards for each jurisdiction are presented in *Appendix G*.

Based on review of aerial photographs, the streets within the Prineville urban area generally don't meet these standards. The primary exceptions appear to be sections of roadway on the edge of the UGB or outside of the city limits.

Many of the City's most critical facilities do not meet access spacing standards. Critical roadways, such as the Prineville "Y" provide undefined access along a broad segment, and areas of Main Street (particularly surrounding the 9th and 10th Street intersections) contain multiple accesses to individual parcels.

Table F-1 summarizes the standards review for the study roadways.

Table F-1 Compliance with Existing Access Spacing Standards

Route Name	Description	Highway Classification	Spacing Standard (Accesses/Mile)	Existing Average Spacing (Accesses/Mile)	Standard Met?
US 26, Ochoco Hwy	Within UGB and east of Prineville	Statewide ¹	11	28	No
US 26, Madras Hwy	West of Prineville UGB to Madras	Regional	15 21	33 50	No No
OR 27, Crooked River Hwy	Outside City Limits	District	8	4	Yes
OR 126, Ochoco Hwy	Entire Segment	Statewide ²	4 7 11	3 2 24	Yes Yes No
OR 370, O'Neil Hwy	Entire Segment	District	8	10	No
OR 380, Paulina Hwy	Entire Segment	District	21	32	No

¹ STA= Special Transportation Area – from Milepost 18.24 (Locust Avenue) to 19.38 (Spruce Lane)

² EXP= Expressway - from Milepost 1.37 (within Redmond) to 17.92 (O'Neil Highway)

As summarized in Table F-1, existing ODOT access spacing standards are not met on many of the state highways. Over time, as development or redevelopment occurs, the City will need to look for opportunities to consolidate access points and to close others where alternative access can be provided on a lower-order facility.

The City of Prineville has developed access spacing guidelines documented in their Land Use Code (*Chapter 153, Section 195: Access Management*). Section 153.195(C) includes *General* access management guidelines, as summarized in Table F-2.

Table F-2 City of Prineville General Access Management Guidelines

Functional Classification	Minimum Spacing Between Driveways and/or Streets	Minimum Driveway Spacing ¹
Major Arterial	500 feet	0.25 miles
Minor Arterial	300 feet	600 feet
Collector	50 feet	300 feet
Local Street	access to each lot	300 feet

Section 153.195(D) includes *Special* access spacing guidelines that vary by highway segment.

ODOT’s access spacing standards are organized by intersection traffic control and functional classification. A spacing of a ½-mile between traffic signals is desired for statewide and regional urban highways (i.e., US 26, OR 126). Table F-3 summarizes the minimum distance between driveways or unsignalized public street intersections on urban highways.

Table F-3 ODOT Access Management Spacing Standards for Highways

Posted Speed Limit	Minimum Spacing Required					
	Statewide (AADT > 5,000)		Regional (AADT ≤ 5,000)		District (AADT ≤ 5,000)	
	Feet	Access/Mile	Feet	Access/Mile	Feet	Access/Mile
≤ 25 mph	350	15	150	35	150	35
30 mph and 35 mph	500	11	250	21	250	21
40 mph and 45 mph	800	7	360	15	360	15
50 mph	1,100	5	425	12	425	12
≥ 55 mph	1,320	4	650	8	650	8

Source: Oregon Highway Plan implemented by OAR 734, Division 51.

Within the Prineville urban area, US 26, OR 126, OR 27 and OR 380 are subject to ODOT’s standards. The classification and unsignalized access standards for each ODOT highway are summarized in Table F-4.

Table F-4 ODOT Spacing Standards for Study Roadways

Route Name	Description	Highway Classification	AADT >5,000	Posted Speed (mph)	Access Spacing Standard (feet)	Accesses Allowed (per mile)
US 26, Ochoco Hwy	East of Prineville "Y"	Statewide ¹	Yes	30	500	11
US 26, Madras Hwy	West of Prineville "Y"	Regional	No	40 30	360 250	15 21
OR 27, Crooked River Hwy	Outside City Limits	District	No	55	650	8
OR 126, Ochoco Hwy	Entire Segment	Statewide ²	Yes	55 45 30	1320 800 500	4 7 11
OR 370, O'Neil Hwy	Entire Segment	District	No	55	650	8
OR 380, Paulina Hwy	Entire Segment	District	No	35	250	21

¹ STA= Special Transportation Area – from Milepost 18.24 (Locust Avenue) to 19.38 (Spruce Lane)

² EXP= Expressway - from Milepost 1.37 (within Redmond) to 17.92 (O'Neil Highway)

Section 5
Technical Memorandum 5: Future No-Build Conditions



CITY OF PRINEVILLE TRANSPORTATION SYSTEM PLAN



TECHNICAL MEMORANDUM #5: FUTURE NEEDS

This memorandum summarizes year 2035 transportation system needs throughout the City of Prineville. These needs were identified through an analysis of the existing transportation system deficiencies (as summarized in Technical Memorandum #3), input received from Prineville citizens and business owners, and a forecast of year 2035 transportation demands. The analyses and findings contained in this memorandum can be used to inform the identification and evaluation of future multimodal transportation system alternatives that meet the goals, policies and criteria guiding the Transportation System Plan (TSP).

All of the technical analyses summarized herein assume that the City will continue to see growth in employment and population between now and the year 2035 in a manner consistent with the existing Comprehensive Plan land use designations, within the existing Urban Growth Boundary (UGB) and consistent with the statewide and regional growth forecasts. At the same time, the analyses assume that the street, transit, pedestrian and bicycle systems will remain as they exist today. This “do nothing” approach from a transportation perspective is commonly used as a foundation by which cities can test the effectiveness of potential projects, policies, and programs. This testing of alternatives helps policy makers to weigh trade-offs regarding future funding priorities in a manner that ensures that the transportation system supports and enhances the continued economic growth, and contributes to the community vision in a manner that is safe, sustainable, fundable and diverse.

The remainder of this memorandum outlines the analyses assumptions and findings. In addition, examples of strategies that the city may consider in the future to address some of the needs are also highlighted.

DEVELOPMENT OF YEAR 2035 TRAFFIC FORECASTS

Estimates of future traffic demand is based on estimated population and employment in the year 2035, existing travel patterns, transportation infrastructure (existing system and planned/funded improvements), and census journey-to-work data. The following section summarizes key aspects of the Prineville 2035 traffic volume estimate.

Land Use and Population Projections

Based on a variety of data sources, ODOT's Transportation Planning Analysis Unit (TPAU) has created a travel demand forecasting model to help inform future traffic demand. Figures 5-1 and 5-2 illustrates the change in population and employment density throughout the City to highlight the general areas and scale of anticipated to job and housing growth.

A key consideration on the Prineville transportation system is the influence from development of lands outside of the City. The recent approval of several destination resorts to the west and ongoing residential growth within Juniper Canyon creates external demands on the City infrastructure. ODOT's travel demand model accounts for this growth.

Year 2010 Journey-to-Work Data

Journey-to-work data from the 2010 Census provides information about travel and employment characteristics in the City. The employment patterns have a significant impact on travel patterns during the peak commute periods, and are helpful for understanding land use trends. Overall, the available 2010 census data shows that Prineville has a workforce of approximately 3,581 persons. Of these, 2,144 Prineville residents commute outside the City for work, and about 1,437 both live and work within City limits (40 percent of the workforce). The data also shows that approximately 3,066 employees commute into Prineville for work.¹

Planned and Funded Projects

Year 2035 needs assume that the only new transportation projects that are constructed in the future are those that are already under development and funded. These projects could be part of the ODOT Statewide Transportation Improvement Program (STIP), or City/County projects.

ODOT's 2012 to 2015 STIP includes a project to improve the pavement conditions along the OR 126 grade. No changes to the number of lanes or configuration of the highway are planned as part of this project, so no change in travel patterns is expected to occur as a result. No other projects are included in the STIP.

The Draft 2015 through 2018 STIP includes a joint application from the City of Prineville and Crook County to improve the Tom McCall and Millican intersections with OR 126. This project would consolidate the intersections to a single location and include a traffic signal or roundabout. Given that the draft STIP projects are still under review, the 2035 analyses do not include this project.

¹ Source: <http://onthemap.ces.census.gov/>

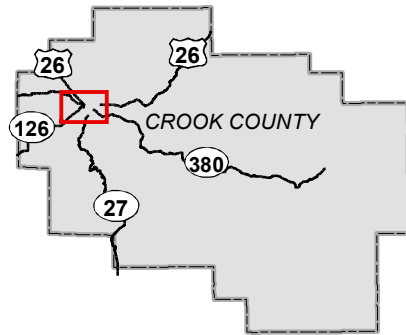

Increase in Households Per Acre

- 0.00 - 0.11
- 0.12 - 0.38
- 0.39 - 0.81
- 0.82 - 1.78
- 1.79 - 3.21
- City Boundary
- UGB

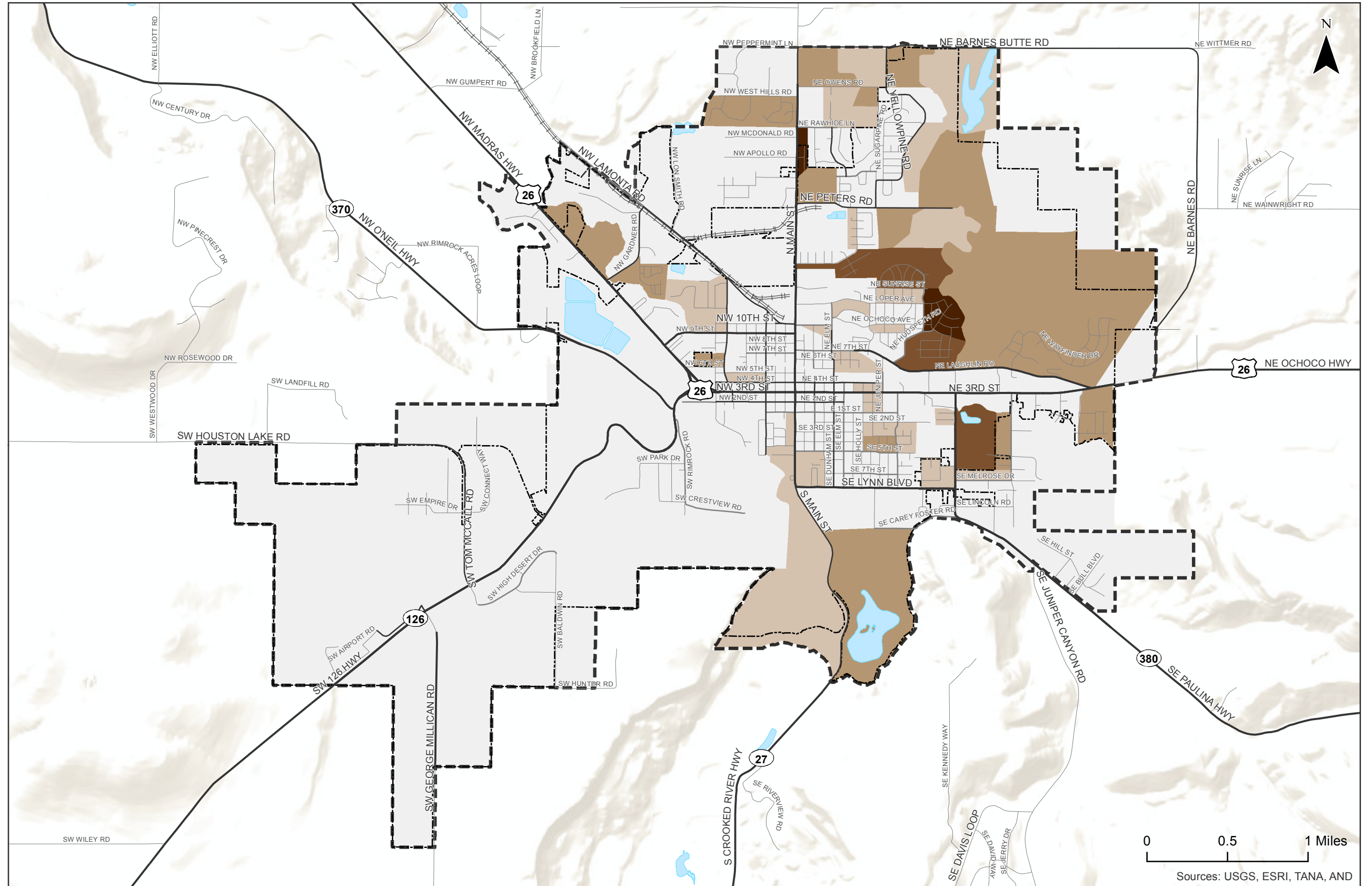

Sources: USGS, ESRI, TANA, AND

**Increase in Households Per Acre
Per TAZ from 2010 to 2035
City of Prineville, Oregon**

**Figure
5-1**

H:\projects\12221 - Prineville TSP\gis\Memo 5\Increase in Households.mxd - 4:29 PM 2/13/2013

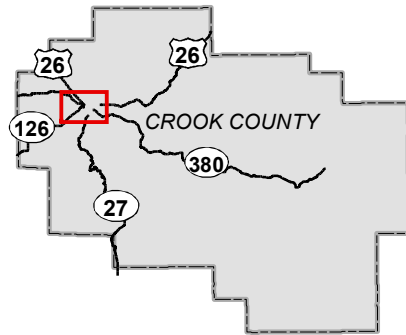

Increase in Employees Per Acre

- 0.00 - 0.82
- 0.88 - 1.64
- 1.78 - 2.46
- 2.61 - 3.28
- 4.10
- City Boundary
- UGB

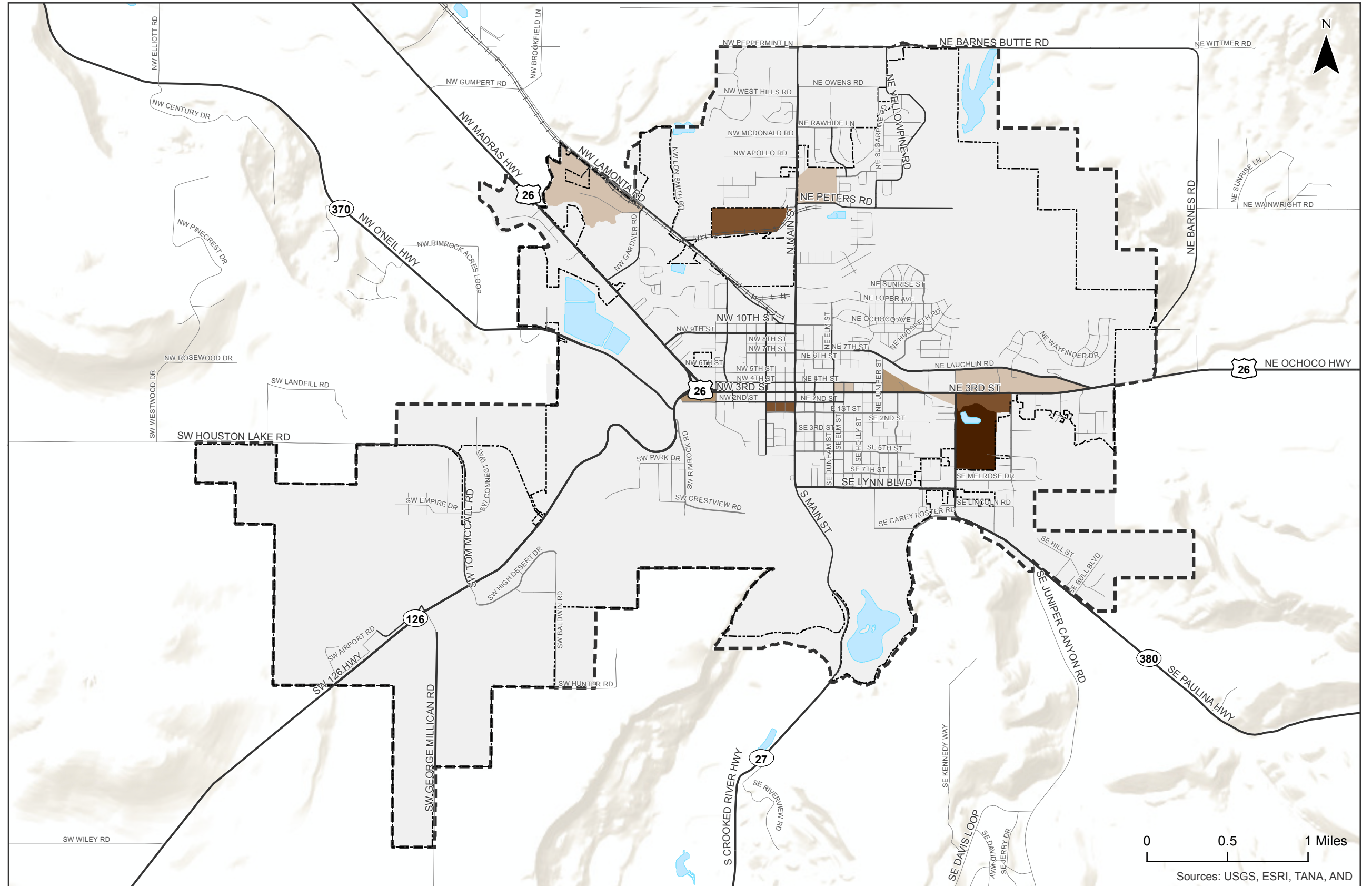

Sources: USGS, ESRI, TANA, AND

**Increase in Employees Per Acre
Per TAZ from 2010 to 2035
City of Prineville, Oregon**

**Figure
5-2**

H:\projects\12221 - Prineville TSP\gis\Memo 5\Increase in Employees.mxd - jscamerliffe - 4:30 PM 2/13/2013

The City and ODOT are discussing improvements on Main Street to support the westerly 9th Street extension. This project will consider accessibility and signal improvements at the 9th and 10th Street intersections along with potential changes to the Main Street cross-section. The specific improvements that will be provided through this project are not fully known and so are not included in the 2035 analysis; however, the planning and design efforts for this project will occur in parallel and be coordinated with the Transportation System Plan.

The City also intends to rebuild and pave the Ochoco Creek bike and pedestrian trail. This project is partially funded through a \$530,000 grant and will provide six to ten feet of trail width between Harwood and 3rd Street near the Ochoco Plaza. Construction is scheduled to begin in 2013. Although this project provides needed multimodal infrastructure for bicyclists and pedestrians, it will not have a material effect on future vehicular demand estimates.

FUTURE TRAFFIC CONDITIONS AND NEEDS

Year 2035 Forecast Traffic Volumes

Year 2035 travel forecasts received from TPAU were post-processed to estimate future traffic demand on the arterial and collector street system. Generally, the traffic demand reflects approximately 20% to 60% growth in traffic volumes over today's conditions, with higher levels of growth west of Prineville on OR 126.

Analyses of future intersection operations revealed that nearly all of the intersections meet applicable performance standards. Further, the queuing and congestion, particularly on Main Street and 3rd Street (US 26/OR 126) is extensive. Exhibit 5-3 illustrates the system deficiencies throughout the City of Prineville based on driver delay (Level of Service), with more detailed intersection metrics included within Appendices E and F. The primary findings of the analysis are discussed below.

Roadway Congestion Needs

3rd Street - US 26/OR 126

The highest levels of congestion occur along the 3rd Street corridor. Within the downtown area 3rd Street serves consolidated regional traffic from US 26, OR 126, and OR 370, and also serves adjacent businesses and local circulation needs within and adjacent to the downtown. To address these needs, the city could consider a series of strategies that provide capacity improvements to the overall 3rd Street corridor and/or broader system solutions with possible creation of parallel routes.

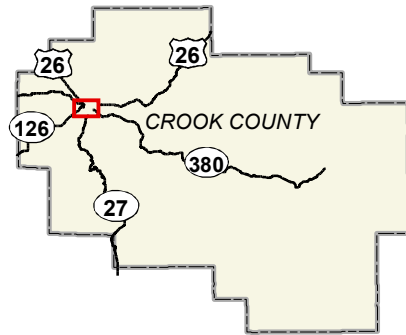

Study Intersection Level-of-Service

- "C" or Better
- "D"
- "E" or "F"

- City Boundary
- Study Area/Urban Growth Boundary (UGB)

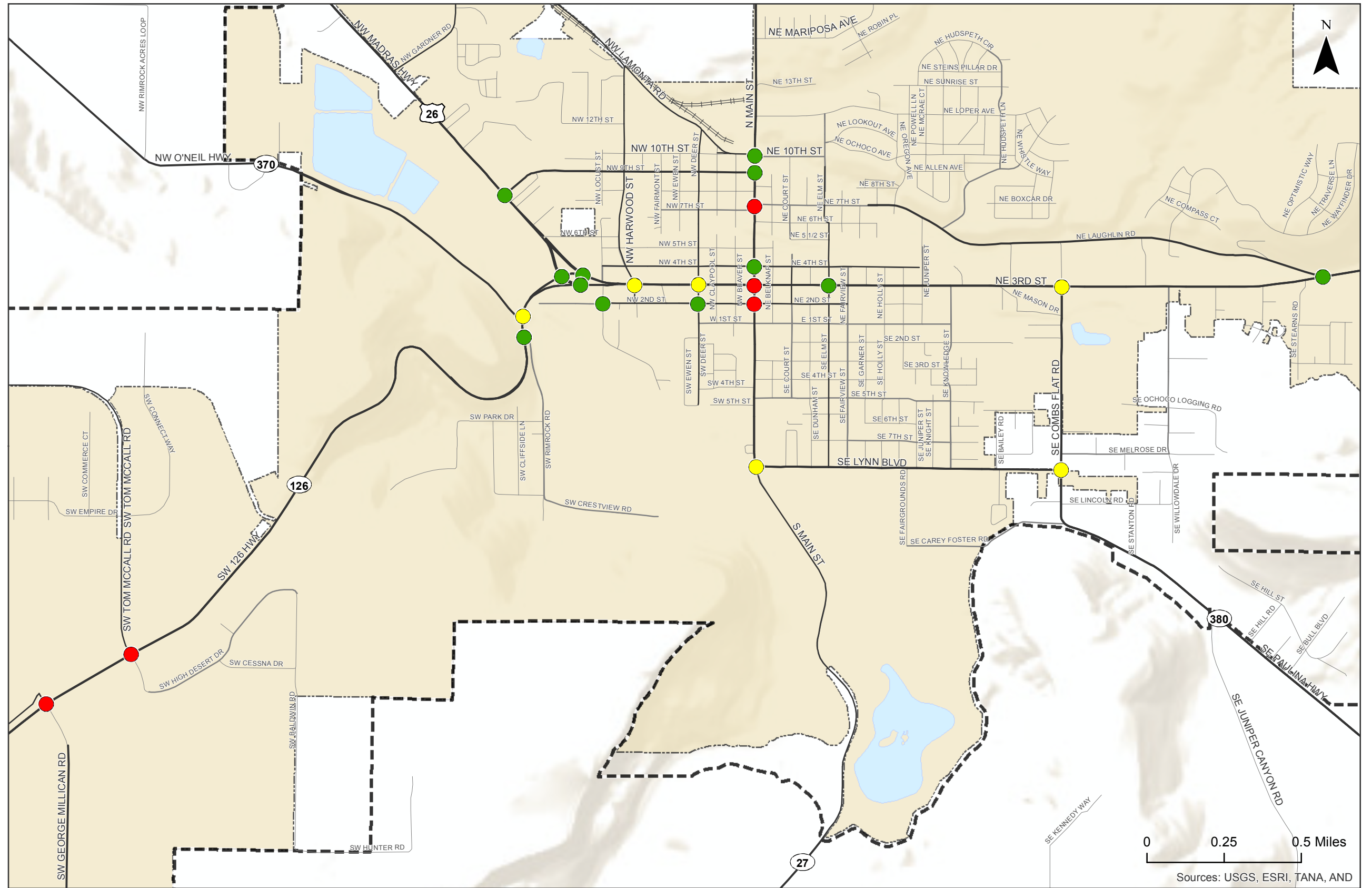

Sources: USGS, ESRI, TANA, AND

**2035 Future No-Build Traffic Conditions
City of Prineville, Oregon**

**Figure
5-3**

Main Street

Main Street could be congested in the future due to the reliance on this route for primary north-south travel in the City. Similar to the 3rd Street corridor, potential improvement options could include the creation of parallel north-south routes. The 2005 TSP includes a number of possible routes that seek to connect the area north of 10th Street both to the east and west of Main Street. Grade differentials, rail spur lines, wetlands, and canals will need to be considered in development of any parallel routes.

Combs Flat Rd

The continued demand for recreational travel to the south and housing within the Juniper Canyon area necessitate future multimodal improvements on Combs Flat Road. Any improvements should consider the need to connect the schools and land uses in the redeveloped Ochoco Lumber Mill site.

Roadway Connectivity

Within the city, a grid network of streets would provide users with a variety of travel options and serve as emergency access routes during incidents. A review of the existing street connectivity needs and constraints revealed the following.

- There is an established grid system within and adjacent to the downtown core. Outside the downtown, connectivity is limited by topography, rail crossings, regional highways and undeveloped properties.
- There are multiple highways that enter the City and converge on 3rd Street. Beyond 3rd Street, there are limited possibilities for serving regional travel within the city.
- Congestion along Main Street and 3rd Street creates barriers to community cohesion. Crossing these streets, either in a vehicle, on a bike or on foot, can be difficult at locations that are not signalized.
- The ability to provide parallel routes to Main Street north of Lamonta – 10th Street is constrained by the spur railway and topographic and environmental constraints.
- Rimrock Road and Crestview Road serve lands west of the Crooked River and south of OR 126. This area is highly constrained due to the rimrock that borders the neighborhood to the west. The single connection that serves this neighborhood occurs along a curved section of OR 126 as Rimrock Road rises to meet the grade of OR 126.

Roadway Safety

Future increases in congestion along Main Street and 3rd Street could affect Citywide crash patterns, such as an increase in rear-end crashes near signalized intersections and higher numbers of turning crashes from driveways and stop-controlled intersections.

In other cases, “through” drivers could seek out parallel routes to avoid congestion on 3rd Street. This could result in increased traffic through residential areas. Adjacent to the downtown, the existing residential streets are wide without cues to drivers to travel at low speeds. Traffic calming may be considered to address livability concerns.

The existing conditions analysis documented in Technical Memorandum #3 noted that ODOT has designated 3rd Street (US 26/OR 126) as a safety priority area based on the high incidence of crashes in comparison with other similar facilities. Other locations identified for further safety review include the intersections of Main Street and 9th Street, Main Street and 4th Street, and Deer Street and 2nd Street.

Future access management on highways and City collector and arterial facilities could benefit safety and operations. New streetscape projects, redevelopment, or changes in use provide opportunities for shared access, creation of easements for future shared access, reduction in the number of driveways, or alternative connectivity to lower-order facilities.

Pedestrian Needs

Pedestrian needs on the system were identified as part of the existing conditions/inventory analysis, and are provided below for reference.

- *Main Street north of 10th Street to City boundary:* The addition of sidewalks along this segment of Main Street would provide a pedestrian connection between residential areas in the north part of the city and civic destinations, such as the pool, schools, and parks.
- *Lynn Boulevard from SE Combs Road to S Main Street:* The addition of sidewalks or a separated path would provide a safe pedestrian connection for students with the adjacent middle school, high school, Central Oregon Community College satellite campus, and access to the fairgrounds.
- *SE Combs Flat Road:* The addition of sidewalks along this segment will help serve students and surrounding residents along one of a limited number of north-south connections in the City. This infrastructure will also support future redevelopment of the Ochoco Lumber site and connect these areas north across 3rd Street to shopping opportunities and ultimately to the Iron Horse property.
- *Fairview between Lynn Boulevard and 3rd Street:* Filling in the sidewalk gaps on Fairview would provide a central north-south corridor.
- *NE 7th Street and Loper Avenue:* Sidewalks along these streets would provide beneficial east-west connections across Prineville's northeast quadrant. To accommodate right-of-way, slope, utilities, and driveway issues, either of these roadways could be improved with a sidewalk along one side of the roadway.
- *O'Neil Highway and OR 126 Connectivity:* Jersey barriers along OR 126 near the O'Neil Highway intersection create a barrier to pedestrian connectivity to the Ochoco Wayside State Park trails.
- *Ochoco Creek Trail System:* The City plans to pave the trail between 3rd Street and Harwood. Extension of this trail system across 3rd Street and into a Combs Flat pedestrian system would link the northwest and southeast portions of the City, and has been considered previously by the City as part of a possible rails-to-trails project along the abandoned rail right-of-way. Extending this connection across 3rd Street and Combs Flat would significantly extend the benefit of this trail.

Bicycle Needs

Bicycle needs within Prineville were identified within the existing conditions analysis and are summarized below.

- *Main Street between Davidson Park and NW 10th Street:* provision of bike lanes would complete a missing gap in the network and provide regional and local north-south connectivity.
- *Parallel east-west routes to 3rd Street:* routing bicycles and providing bike lanes on 2nd Street or 4th Street could be considered. A off-street bike path that follows the 3rd Street alignment could also serve downtown bicycle connectivity needs.
- *SE Combs Flat Road:* a continuous bicycle facility on Combs Flat Road from SE Lynn Boulevard north of 3rd Street would provide connections into the planned Iron Horse development. This could be integrated with pedestrian needs as part of a mixed use trail system or a combination of sidewalks, trails, and bicycle lanes. Main Street
- *Main Street* could be congested in the future due to the reliance on this route for primary north-south travel in the City. Similar to the 3rd Street corridor, potential improvement options could include the creation of parallel north-south routes. The 2005 TSP includes a number of possible routes that seek to connect the area north of 10th Street both to the east and west of Main Street. Grade differentials, rail spur lines, wetlands, and canals will need to be considered in development of any parallel routes.

Transit

Establishment of a park-and-ride facility in Prineville is a near-term need. The designation of the current location on the gravel shoulder of the Prineville “Y” is problematic for all modes to access the site. A more centralized location that provides better illumination, bicycle and pedestrian connectivity, and typical amenities such as shelters and benches would help improve the comfort, convenience, and encourage use of the multi-modal facilities.

On-going efforts being conducted through the Central Oregon Intergovernmental Council are considering better park-and-ride locations throughout the region. When these efforts are completed elements of their transit plan will be incorporated into the City’s Transportation System Plan.

SUMMARY AND NEXT STEPS





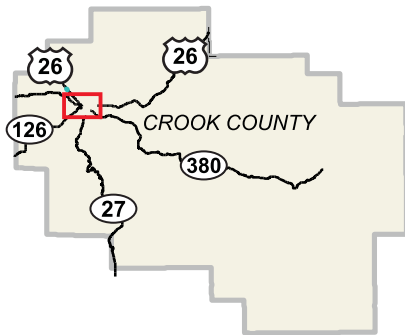

A summary of the transportation system needs as summarized within this memorandum are shown in Figure 5-4. This figure highlights the multi-modal and safety needs throughout the City. These needs will be considered by the Project Management and Advisory Committees as well as at a Community Open House.

ATTACHMENTS:

- Attachment A: Travel Demand Model Process
- Attachment B: Travel Demand Model Request
- Attachment C: Travel Demand Model Plots for No-Build Scenario
- Attachment D: NCHRP Report 255 Worksheets
- Attachment E: Level of Service Worksheets for Future No-Build
- Attachment F: Intersection Performance Summary Table



Transportation Needs

-  = Safety Focus
-  = Intersection Improvement
-  = Pedestrian/Bicycle Connectivity
-  = Vehicular Connectivity
-  = Congested Roadway
-  = ODOT Safety Priority Segment
-  = School

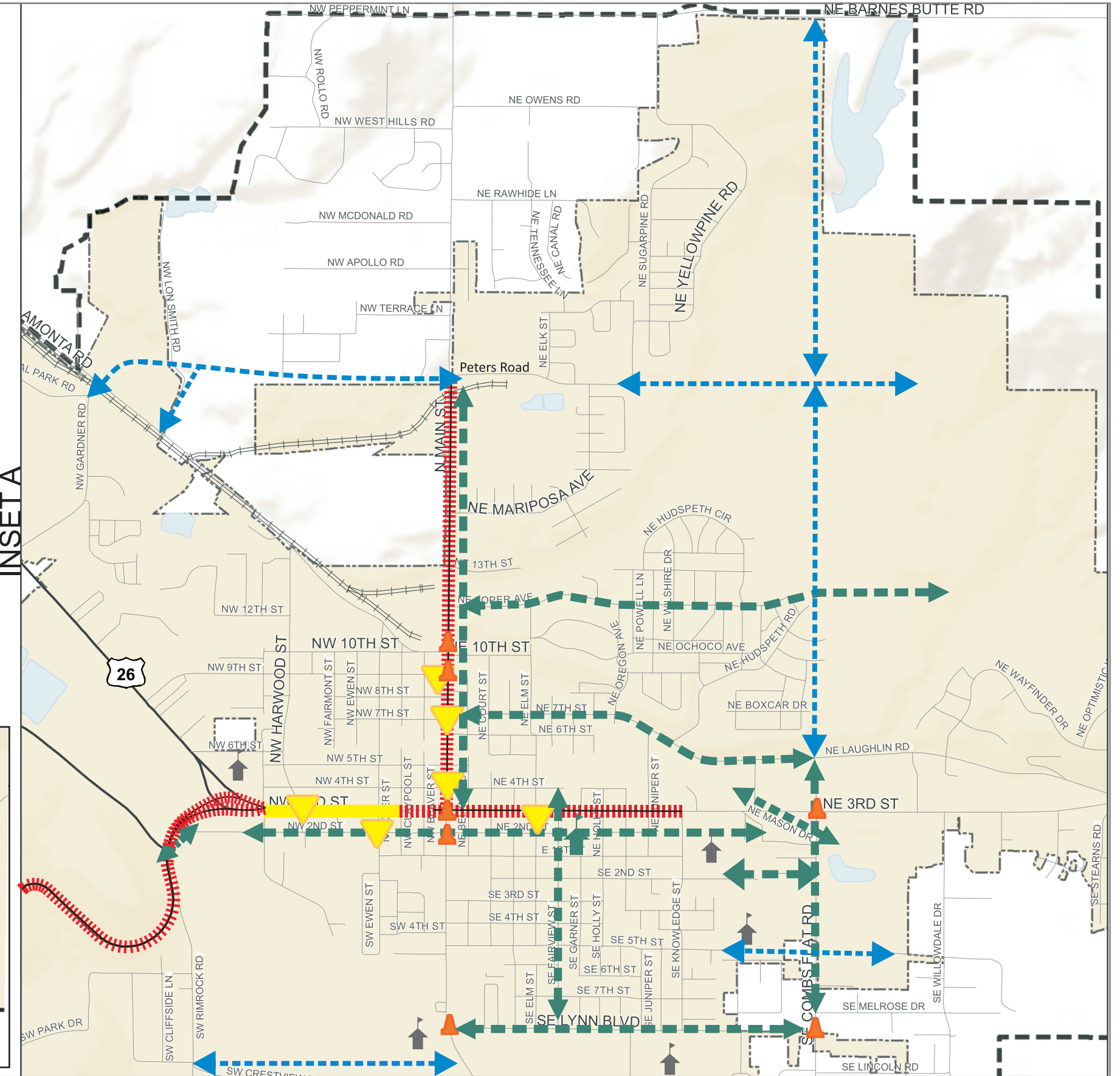
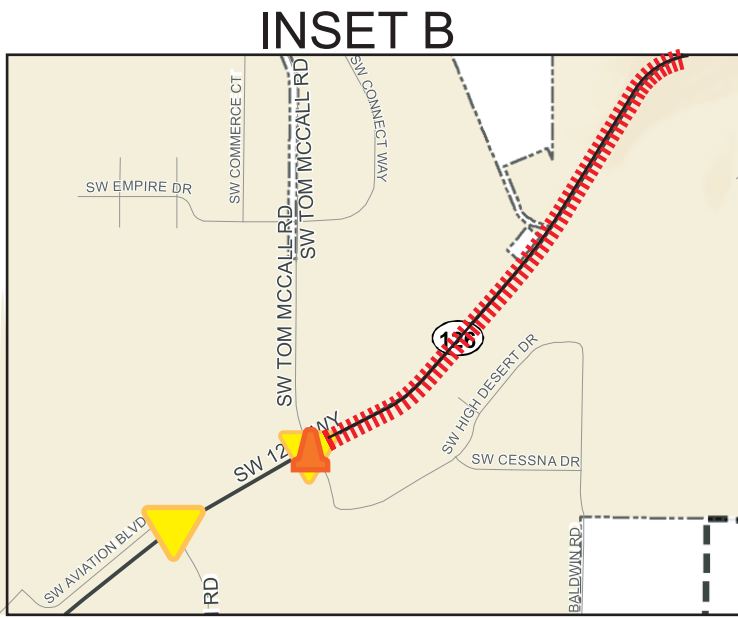
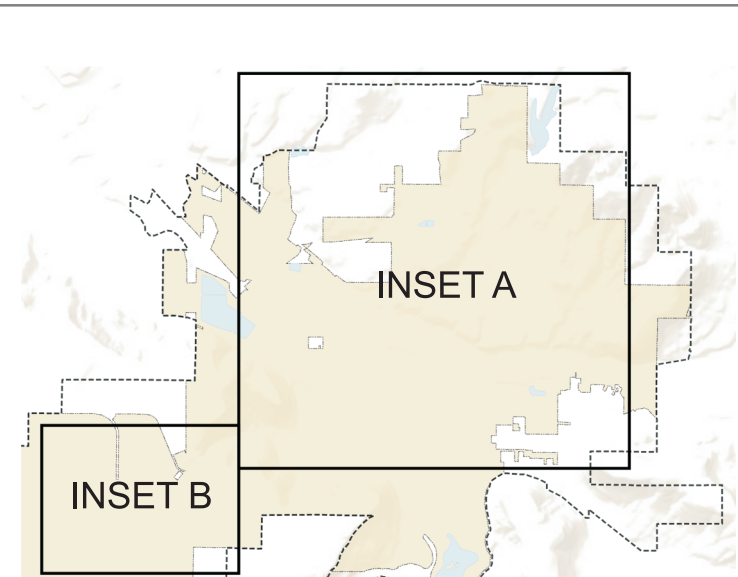

Prineville Transportation Needs
City of Prineville, Oregon

Figure
5-4

**Attachment A
Travel Demand Model Process**

TRAVEL DEMAND MODEL PROCESS

Within the travel demand model, the City is divided into a series of subareas (Transportation Analysis Zones, or TAZs) based on their zoning, parcel boundaries, or other natural or man-made barriers (creeks, railways, or topographic areas). Each of these subareas contains information related to the number of employees (by market sector) and the population (households). This information, which is based on payroll data and census information, is calibrated to the existing traffic counts to ensure that the model accurately reflects the current travel patterns within the City.

Once the base year travel demand models are calibrated, additional information within each of the subareas is provided for the year 2035. This includes population forecasts for the City that are coordinated from the State to Crook County, and then assigned to Prineville. Through 2035, the City anticipates population growth of nearly 1,650 households (approximately 4,000 more people).

The expected growth in population is manually assigned to the subareas by City staff. Generally, growth is assumed to occur on properties that are already entitled or have active planning applications (e.g., Iron Horse, Anglers Canyon, etc.), readily buildable lands, and is conducted with consideration of the existing zoning. This population assignment also considers the allowable densities within the zoning, and leverages other Comprehensive Plan elements such as the City's *Buildable Lands Inventory* and *Housing* elements.

Employment growth in the City is not coordinated through the State, and is generally assumed to maintain current workforce to population ratios. Within Prineville key employment areas include designated portions of Iron Horse, the Ochoco Lumber site, designated industrial property near Main Street – McKay and Peters Road, industrial properties surrounding the airport, and areas along Lamonta Road. In total, approximately 1,750 new jobs are expected in Prineville by 2035.

**Attachment B
Travel Demand Model Request**

REQUEST FOR TRAVEL DEMAND MODEL RUN

BACKGROUND

Travel demand models are used for transportation project development, transportation planning and land use planning. Models are adapted to represent the project/development characteristics and report on the areas affected by the project. Project data is used to update transportation networks and related land use changes. From the time all appropriate data have been received, a typical modeling request takes two to three weeks to complete. The time leading up to the actual model run can take nearly as much time. Therefore, using this request form as a guide to making a request for a model run should greatly reduce the time required to assemble the information needed to start the model run. Requesting agencies should be prepared to discuss details related to their model run request. This may take place as a phone call or a meeting, depending on the complexity of the request.

ISSUES

1. Multiple agencies rely on TPAU for model runs, so there will inevitably be scheduling conflicts. Multiple requests received very close to each other will delay the turnaround time for some projects. When workload is high, requests are prioritized and completed in as timely a manner as possible.
2. Before the model run preparation can begin, detailed and complete information is needed from the requesting agency/firm. This form is designed to collect the following:
 - The project opening year and design year;
 - The project impact area to be included in model run outputs;
 - Socioeconomic changes (employment changes, housing developments, new retail development, etc.) in the project area to be included in model runs;
 - Detailed descriptions of project alternatives to be tested; and
 - A list of other projects to be included in the networks with the project being analyzed.

Please submit requests to:

Brian Dunn
Transportation Planning Analysis Unit
555 13th St. NE, Suite 2
Salem, OR 97301
503.986.4103
Brian.G.Dunn@odot.state.or.us

Submittal of a request using this form is the first step. An agency contact person will follow-up this request with a phone call or meeting as necessary to obtain further detail. This request form serves as the formal documentation for a model run and will be filed as public record. All model parameters changed for a run must be documented and described in detail.

To: Joe Meek
Cc: Sam Ayash

Requesting Agency or Firm: Kittelson & Associates Date of Request: 8/13/2012

Contact Person: Casey Bergh or Joe Bessman

Address 354 SW Upper Terrace Drive, Suite 101
 Bend, Oregon 97702

Email: cbergh@kittelson.com or jbossman@kittelson.com Phone number: 541-312-8300

ODOT Requests: EA to charge _____

Outside ODOT Requests: Please provide billing information if different from above contact information.

Name of Model: Prineville Travel Demand Model

Year(s) Requesting Model Output: Base Year and Future Year

Provide the name and a brief description of the Project using output from the travel demand model:

Prineville TSP

Provide a brief description of purpose, goals and objectives of the model run. Briefly describe how model results will be used. What questions do you seek to answer using this information?

Preparation of forecast traffic volumes for TSP under a “no-build” scenario.

Requestor should become familiar with the model used for analysis. Familiarity should include areas such as model base year, future year, zone structure, network structure and attributes. ODOT will provide a GIS layer or PDF with the TAZ structure, link structure and attributes. All model settings requested must be specified in terms of the model. Street names, addresses and physical landmarks are not sufficient to identify location of changes.

Requestor must provide a complete and detailed description of the changes to be made for the model run, including changes to the network (capacity, speed, new lanes, new or deleted links, etc.) and land use data

(employment, population). Changes to land use must include a narrative detailing supportive assumptions associated with such changes.

Note that travel models provide only generalized travel forecasts because they are based on generalized land use patterns and transportation networks. Since models do not represent individual land uses, driveways or neighborhood-scale streets, the forecasts produced are not sensitive to these specific land use and transportation characteristics.

It is inappropriate to use raw model outputs as the basis for transportation and land use decisions that require consideration of detailed transportation and land use characteristics. Therefore, post-processing of model outputs to account for the influence of specific transportation and land use characteristics is mandatory. Methods used for post-processing must conform to specifications provided within the ODOT Analysis Procedures Manual (http://www.oregon.gov/ODOT/TD/TP/TAPM.shtml#Analysis_Procedures_Manual).

Changes to Network

Changes to Existing Network Attributes

1. Provide brief description of actual change on the street being modeled and the expected effect of such a change.
2. Identify the network links to be changed using “From Node - To Node” or link ID. Specify what attribute(s) is to be changed and what the change is.
3. Provide a map illustrating location and reference to description of changes.

Note: If a large number of network changes or several model runs are being requested, submit information using a spreadsheet listing out individual projects. A map illustrating the requested network changes should also be provided for each run separately. Note that separate networks exist for roads, transit and walk.

Model Changes to be Made: Network Attributes

Project w/ brief description	Network Action: - change link attribute - new link (include map)	Link ID (Fnode-Tnode)	Change Attribute: - speed - lanes - FC - Signal - Other?	Project Number (1, 2, 3)
None				

Projects Included in Scenario

Scenario Number	Projects Included	Notes:
1	None	Base model run
2	None	Future model run – no projects added

Additions/Deletions to Existing Network

1. Provide brief description of actual change on the street being modeled.
2. Identify the addition/deletion to be made to network. Include attributes of new links and nodes.
3. Provide a map illustrating the location and nature of changes to be made. Clearly identify where new links are connected to original network.
4. Review nearby connectors and how they relate to the altered network. Identify necessary changes to connectors.

Note: If a large number of network changes or several model runs are being requested, submit information using a spreadsheet listing out individual projects. Separate maps illustrating the requested network changes should be provided for each scenario separately. Note that separate networks exist for road, transit and walk.

Model Changes to be Made: Network Attributes

Project w/ brief description	Network Action: - delete link - add new link - change connector	Network Attributes: - speed - lanes - FC - Signal?	Project Number (1, 2, 3)
None			

Projects Included in Scenario

Scenario Number	Projects Included	Notes:
1	None	
2	None	

Output Requested from Model Run Request:

Menu of Standard ODOT Travel Demand Model Outputs					
Select Output Format					
Shape File*	Model Network**	PDF file	Time of Day	<input checked="" type="checkbox"/> Peak Hour	<input checked="" type="checkbox"/> Daily
<input checked="" type="checkbox"/>	<input type="checkbox"/>	<input checked="" type="checkbox"/>	Link Volume– link text only		
NA	<input type="checkbox"/>	<input type="checkbox"/>	Link Volume– bandwidths with link text		
<input checked="" type="checkbox"/>	<input type="checkbox"/>	<input checked="" type="checkbox"/>	Select Link Volume		
<input type="checkbox"/>	<input type="checkbox"/>	<input type="checkbox"/>	Select Zone Volume		
<input checked="" type="checkbox"/>	<input type="checkbox"/>	<input checked="" type="checkbox"/>	Demand to Capacity Ratio		
<input type="checkbox"/>	<input type="checkbox"/>	<input type="checkbox"/>	Absolute Volume Difference– link text only		
<input type="checkbox"/>	<input type="checkbox"/>	<input type="checkbox"/>	Relative Volume Difference - link text only		
NA	<input type="checkbox"/>	<input type="checkbox"/>	Absolute Volume Difference– bandwidths with link text		
NA	<input type="checkbox"/>	<input type="checkbox"/>	Relative Volume Difference– bandwidths with link text		
<input type="checkbox"/>	<input type="checkbox"/>	<input type="checkbox"/>	Other:		
<input type="checkbox"/>	<input type="checkbox"/>	<input type="checkbox"/>	Other:		
* VISUM model only					
** EMME2 or VISUM					

Definitions:

- Link Volume – The peak hour (or daily if requested) traffic using each link (street) for a requested area or for the entire model network.
- Select Link or Zone Volume (also called “flow bundles” by ptv-VISUM) – Represents the traffic using a given link or zone or group of links or zones. They graphically represent the origins and destinations of select links and/or zones and display all of the travel patterns associated with the selected locations. These are typically used to apply trip rates (like ITE trip generation) to the network, or to better understand an area and the users.
- Demand to Capacity Ratio – This is a ratio of the model volume (usually hourly volume, although daily can be requested) to the model capacity. In the future years the volume on a given link may be greater than the volume that could pass through that point in an hour, due to great congestion on the network and the principles behind travel demand models. For this reason the word demand is used not volume, as the model volume might be greater than the actual volume (by definition the volume to capacity ratio must never be greater than 1). The capacity is the model capacity, which represents a mid street capacity. Facility type and speed go into determining this capacity. Note that the model capacity is not a saturation flow; the model capacity needs to account for the capacity reductions due to intersections. The measure of demand to capacity is – model volume / model capacity – given for a requested area.

- Volume Difference, Absolute & Relative – Absolute Volume difference is the subtraction of the volume that results from the model run requested verses a reference (or base) run, usually the finically constrained future year run, but it can be any reference case desired by the requestor. Relative volume would be the percentage change from the requested run and the reference run specified by the requestor.
- O & D Matrix – The full Origin – Destination Matrix that the model uses to assign trips to the network can be requested. TPAU will also help with Aggregated O & D Matrices to the district level, which can be plotted graphically along with select links or zones. If desired, TPAU will work with the requestor to help answer traffic flow questions that require O & D matrices or District-to-District plotting.
- Bandwidths – The link volume can be represented graphically with a bar whose thickness is directly related to the volume of the link, meaning that the larger the volume the thicker the bar.

Internal Use Only – TPAU Model Run Documentation and Organization Info

Model Name: _____ Project Name: _____ Model Run(s) Number: _____

Date Reviewed by MPO: _____ Date Received by TPAU: _____

Date Accepted by TPAU as Final/Complete Request: _____

Date Request Completed: _____

TPAU Analyst(s): _____ MPO/Region Cc'd? _____

Attachment C
Travel Demand Model Plots for No-Build Scenario

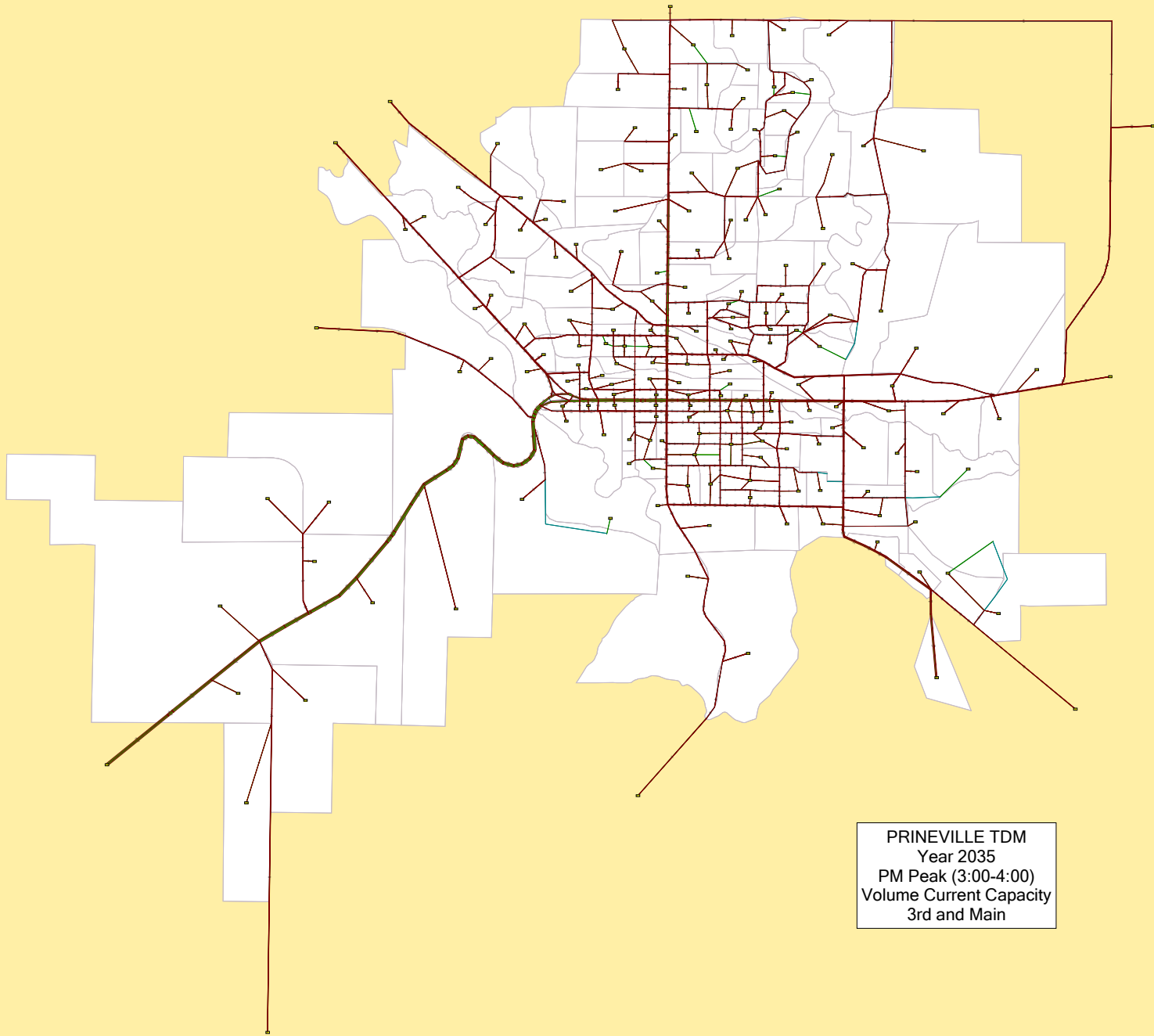

PRINEVILLE TDM
Year 2035
PM Peak (3:00-4:00)
Volume Current Capacity
3rd and Main

**Attachment D
NCHRP Report 255 Worksheets**

Project # 12221
 Project Name City of Prineville Transportation System Plan
 City, State Prineville, Oregon
 Scenario Year 2012 Existing Traffic Conditions, Weekday PM Peak Hour
 Date 11/27/2012
 File Name Path H:\projfiles\12221 - Prineville TSP\excel\NCHRP255.xlsx
 Prepared By

Existing Count Year 2012
 Base Model Year 2010
 Future Model Year 2035

Intersection Name	Leg	Movement	Existing Link			Base Model Link Volume	Future Model Link Volume	Base to Future Model Growth Factor	Adjusted Base Model Volumes	Base Model: Existing Volume	Ratio Method (Existing / Future-Base)	Difference Method (Ex. + Future - Base)	Average of Ratio & Difference Method	Selected 255 Volume	Growth Factor (From Ex. Count Year)
			Left	Thru	Right										
Hawcroft St / Lamona Rd	South	In	28	1	16	39	34	0.87	16	0	41	40	41	41	104%
		Out	17	1	21	39	17	0.44	16	0	41	40	41	41	104%
	West	In	1	175	1	197	187	0.95	187	0	189	1	206	228	119%
		Out	28	121	21	150	182	1.21	184	1	166	169	168	168	112%
	North	In	1	1	1	3	3	1.00	3	1	3	3	3	3	100%
Out		1	1	1	3	3	1.00	3	1	3	3	3	3	100%	
East	In	17	121	1	139	161	1.16	151	1	420	535	478	478	344%	
	Out	1	175	10	186	182	0.98	182	0	215	513	563	538	289%	
			Total			756	737	0.97	809	1	1533	1598	1560	1560	206%

Intersection Name	Leg	Movement	Existing Link			Base Model Link Volume	Future Model Link Volume	Base to Future Model Growth Factor	Adjusted Base Model Volumes	Base Model: Existing Volume	Ratio Method (Existing / Future-Base)	Difference Method (Ex. + Future - Base)	Average of Ratio & Difference Method	Selected 255 Volume	Growth Factor (From Ex. Count Year)
			Left	Thru	Right										
Oak St / Lamona Rd	South	In	25	1	11	37	12	0.32	12	0	23	23	23	23	100%
		Out	2	1	20	23	7	0.30	12	0	23	23	23	23	100%
	West	In	1	168	20	190	178	0.94	178	0	179	1	228	227	119%
		Out	25	131	1	157	191	2.00	192	1	164	165	165	165	105%
	North	In	1	1	1	3	3	1.00	3	1	3	3	3	3	100%
Out		1	1	1	3	3	1.00	3	1	3	3	3	3	100%	
East	In	1	169	11	181	170	0.94	173	1	218	216	217	217	120%	
	Out	1	169	11	181	170	0.94	173	1	218	216	217	217	120%	
			Total			728	742	1.02	810	1	812	814	813	813	112%

Intersection Name	Leg	Movement	Existing Link			Base Model Link Volume	Future Model Link Volume	Base to Future Model Growth Factor	Adjusted Base Model Volumes	Base Model: Existing Volume	Ratio Method (Existing / Future-Base)	Difference Method (Ex. + Future - Base)	Average of Ratio & Difference Method	Selected 255 Volume	Growth Factor (From Ex. Count Year)
			Left	Thru	Right										
Main Street / 10th Street	South	In	84	311	30	425	749	1.76	760	2	471	540	511	511	124%
		Out	25	323	99	447	526	1.18	526	0	570	480	480	480	100%
	West	In	103	30	95	218	175	0.80	189	1	452	405	428	428	176%
		Out	84	8	38	152	182	1.20	189	1	189	216	202	202	105%
	North	In	5	388	37	429	429	1.00	429	0	429	532	552	552	129%
Out		12	31	1	45	36	0.80	37	1	47	48	48	48	130%	
East	In	1	24	22	55	52	0.95	52	1	58	59	58	58	124%	
	Out	1	24	22	55	52	0.95	52	1	58	59	58	58	124%	
			Total			2166	2579	1.20	2661	1	2654	3022	2953	2953	140%

Intersection Name	Leg	Movement	Existing Link			Base Model Link Volume	Future Model Link Volume	Base to Future Model Growth Factor	Adjusted Base Model Volumes	Base Model: Existing Volume	Ratio Method (Existing / Future-Base)	Difference Method (Ex. + Future - Base)	Average of Ratio & Difference Method	Selected 255 Volume	Growth Factor (From Ex. Count Year)
			Left	Thru	Right										
Main St / 9th St	South	In	110	414	38	562	622	1.11	620	0	545	601	545	545	97%
		Out	1	415	106	522	421	0.81	421	0	545	601	545	545	97%
	West	In	21	5	106	132	174	1.32	174	1	134	135	134	134	102%
		Out	12	1	1	15	12	0.80	12	2	215	142	142	142	66%
	North	In	16	415	36	467	506	1.08	523	1	643	664	653	653	140%
Out		21	414	4	439	458	1.04	481	1	683	707	695	695	138%	
East	In	1	2	4	7	6	0.86	6	1	23	24	24	24	104%	
	Out	16	5	38	59	28	0.47	28	0	58	27	27	27	47%	
			Total			2336	2379	1.02	2456	1	3183	3227	3205	3205	137%

Intersection Name	Leg	Movement	Existing Link			Base Model Link Volume	Future Model Link Volume	Base to Future Model Growth Factor	Adjusted Base Model Volumes	Base Model: Existing Volume	Ratio Method (Existing / Future-Base)	Difference Method (Ex. + Future - Base)	Average of Ratio & Difference Method	Selected 255 Volume	Growth Factor (From Ex. Count Year)
			Left	Thru	Right										
Main St / 7th St	South	In	12	389	44	445	516	1.15	516	0	522	619	522	522	117%
		Out	23	315	12	350	371	1.06	372	1	361	362	362	362	103%
	West	In	4	5	12	21	18	0.86	18	1	25	25	25	25	119%
		Out	12	1	0	13	22	1.69	22	2	15	15	15	15	115%
	North	In	174	315	0	489	434	0.89	436	1	517	514	515	515	105%
Out		4	359	180	523	623	1.19	641	1	652	661	657	657	101%	
East	In	23	1	180	204	216	1.06	218	1	230	232	231	231	113%	
	Out	174	5	44	223	161	0.72	164	1	274	261	267	267	120%	
			Total			2318	2373	1.02	2397	1	2588	2599	2594	2594	112%

Intersection Name	Leg	Movement	Existing Link			Base Model Link Volume	Future Model Link Volume	Base to Future Model Growth Factor	Adjusted Base Model Volumes	Base Model: Existing Volume	Ratio Method (Existing / Future-Base)	Difference Method (Ex. + Future - Base)	Average of Ratio & Difference Method	Selected 255 Volume	Growth Factor (From Ex. Count Year)
			Left	Thru	Right										
Juliana St / Laughlin Rd	South	In	18	1	17	36	49	1.36	49	0	72	71	82	82	233%
		Out	19	1	24	44	14	0.32	14	0	118	72	95	95	216%
	West	In	1	250	246	507	490	0.97	490	0	516	520	516	516	100%
		Out	18	209	1	228	203	0.90	207	1	281	276	278	278	122%
	North	In	1	1	1	3	3	1.00	3	1	3	3	3	3	100%
Out		1	1	1	3	3	1.00	3	1	3	3	3	3	100%	
East	In	19	209	1	229	174	0.78	180	1	319	300	309	309	135%	
	Out	1	225	17	243	159	0.66	168	1	386	341	364	364	150%	
			Total			1036	760	0.73	790	1	1492	1384	1438	1438	139%

Intersection Name	Leg	Movement	Existing Link			Base Model Link Volume	Future Model Link Volume	Base to Future Model Growth Factor	Adjusted Base Model Volumes	Base Model: Existing Volume	Ratio Method (Existing / Future-Base)	Difference Method (Ex. + Future - Base)	Average of Ratio & Difference Method	Selected 255 Volume	Growth Factor (From Ex. Count Year)
			Left	Thru	Right										
Combs Pl / Laughlin Rd	South	In	76	1	11	88	100	1.14	105	1	137	146	141	141	161%
		Out	1	92	100	183	119	0.65	119	0	228	180	196	196	105%
	West	In	1	82	92	185	151	0.82	150	0	301	285	283	283	105%
		Out	76	86	1	163	167	1.02	171	1	184	192	188	188	131%
	North	In	1	1	1	3	3	1.00	3	1	3	3	3	3	100%
Out		1	1	1	3	3	1.00	3	1	3	3	3	3	100%	
East	In	7	66	1	74	138	1.88	142	2	99	122	110	110	149%	
	Out	1	92	11	104	100	0.96	108	1	188	191	190	190	103%	
			Total			700	709	1.01	745	1	1084	1108	1096	1096	157%

Intersection Name	Leg	Movement	Existing Link			Base Model Link Volume	Future Model Link Volume	Base to Future Model Growth Factor	Adjusted Base Model Volumes	Base Model: Existing Volume	Ratio Method (Existing / Future-Base)	Difference Method (Ex. + Future - Base)	Average of Ratio & Difference Method	Selected 255 Volume	Growth Factor (From Ex. Count Year)
			Left	Thru	Right										
Main St / 4th St N	South	In	17	330	34	380	376	0.99	385	1	479	480	480	480	126%
		Out	7	261	55	323	264	0.82	264	0	516	520	516	516	100%
	West	In	18	19	54	92	53	0.58	53	1	92	92	92	92	100%
		Out	16	1	26	43	17	0.40	17	0	90	75	77	77	86%
	North	In	70	261	28	357	387	1.09	388	1	370	371	370	370	104%
Out		18	330	48	396	534	1.35	541	1	657	680	468	468	118%	
East	In	7	8	48	63	61	0.97	61	0	61	61	61	61	100%	
	Out	70	19	34	123	2	0.02	2	0	468	130	288	130	108%	
			Total			1780	1756	0.98	1796	1	2227	2241	2229	2229	126%

Intersection Name	Leg	Movement	Existing Link			Base Model Link Volume	Future Model Link Volume	Base to Future Model Growth Factor	Adjusted Base Model Volumes	Base Model: Existing Volume	Ratio Method (Existing / Future-Base)	Difference Method (Ex. + Future - Base)	Average of Ratio & Difference Method	Selected 255 Volume	Growth Factor (From Ex. Count Year)
			Left	Thru	Right										
US 26W / 8th St	South	In	1	154	39	194	356	1.83	356	0	218	239	229	229	119%
		Out	24	137	1	162	204	1.26	209	1	203	215	209	209	129%
	West	In	1	1	1	3	3	1.00	3	1	3	3	3	3	100

**Attachment E
Level of Service Worksheets for Future No-Build**

HCM Unsignalized Intersection Capacity Analysis

1: Lamonta Rd & Harwood St

2/14/2013



Movement	EBT	EBR	WBL	WBT	NBL	NBR
Lane Configurations	→			←	↘	↙
Volume (veh/h)	250	50	40	170	15	40
Sign Control	Free			Free	Stop	
Grade	0%			0%	0%	
Peak Hour Factor	0.85	0.85	0.85	0.85	0.85	0.85
Hourly flow rate (vph)	294	59	47	200	18	47
Pedestrians						
Lane Width (ft)						
Walking Speed (ft/s)						
Percent Blockage						
Right turn flare (veh)						
Median type	None			None		
Median storage (veh)						
Upstream signal (ft)						
pX, platoon unblocked						
vC, conflicting volume			353		618	324
vC1, stage 1 conf vol						
vC2, stage 2 conf vol						
vCu, unblocked vol			353		618	324
tC, single (s)			4.1		6.5	6.2
tC, 2 stage (s)						
tF (s)			2.2		3.6	3.3
p0 queue free %			96		96	93
cM capacity (veh/h)			1217		422	722

Direction, Lane #	EB 1	WB 1	NB 1
Volume Total	353	247	65
Volume Left	0	47	18
Volume Right	59	0	47
cSH	1700	1217	605
Volume to Capacity	0.21	0.04	0.11
Queue Length 95th (ft)	0	3	9
Control Delay (s)	0.0	1.8	11.7
Lane LOS		A	B
Approach Delay (s)	0.0	1.8	11.7
Approach LOS			B

Intersection Summary			
Average Delay		1.8	
Intersection Capacity Utilization		43.3%	ICU Level of Service A
Analysis Period (min)		15	

HCM Unsignalized Intersection Capacity Analysis

2: Lamonta Rd & NW Deer St

2/14/2013



Movement	EBT	EBR	WBL	WBT	NBL	NBR
Lane Configurations						
Volume (veh/h)	270	30	5	190	25	10
Sign Control	Free			Free	Stop	
Grade	0%			0%	0%	
Peak Hour Factor	0.85	0.85	0.85	0.85	0.85	0.85
Hourly flow rate (vph)	318	35	6	224	29	12
Pedestrians						
Lane Width (ft)						
Walking Speed (ft/s)						
Percent Blockage						
Right turn flare (veh)						
Median type	None			None		
Median storage (veh)						
Upstream signal (ft)	697					
pX, platoon unblocked						
vC, conflicting volume			353			571 335
vC1, stage 1 conf vol						
vC2, stage 2 conf vol						
vCu, unblocked vol			353			571 335
tC, single (s)			4.1			6.4 6.3
tC, 2 stage (s)						
tF (s)			2.2			3.5 3.4
p0 queue free %			100			94 98
cM capacity (veh/h)			1217			477 691

Direction, Lane #	EB 1	WB 1	NB 1
Volume Total	353	229	41
Volume Left	0	6	29
Volume Right	35	0	12
cSH	1700	1217	523
Volume to Capacity	0.21	0.00	0.08
Queue Length 95th (ft)	0	0	7
Control Delay (s)	0.0	0.2	12.5
Lane LOS		A	B
Approach Delay (s)	0.0	0.2	12.5
Approach LOS			B

Intersection Summary			
Average Delay			0.9
Intersection Capacity Utilization	27.4%		ICU Level of Service A
Analysis Period (min)			15

Queues

3: Main St & 10th St

12/12/2013



















	→	↘	←	↑	↓
Lane Group	EBT	EBR	WBT	NBT	SBT
Lane Group Flow (vph)	199	160	87	696	688
v/c Ratio	0.59	0.31	0.23	0.61	0.46
Control Delay	21.8	4.9	12.2	11.4	9.0
Queue Delay	0.0	0.0	0.0	0.0	0.0
Total Delay	21.8	4.9	12.2	11.4	9.0
Queue Length 50th (ft)	37	0	11	56	51
Queue Length 95th (ft)	87	19	35	92	82
Internal Link Dist (ft)	370		379	203	3918
Turn Bay Length (ft)		130			
Base Capacity (vph)	542	728	670	1699	2223
Starvation Cap Reductn	0	0	0	0	0
Spillback Cap Reductn	0	0	0	0	0
Storage Cap Reductn	0	0	0	0	0
Reduced v/c Ratio	0.37	0.22	0.13	0.41	0.31

Intersection Summary

HCM Signalized Intersection Capacity Analysis

3: Main St & 10th St

12/12/2013



















												
Movement	EBL	EBT	EBR	WBL	WBT	WBR	NBL	NBT	NBR	SBL	SBT	SBR
Lane Configurations												
Volume (vph)	115	28	115	16	34	13	90	367	44	7	452	36
Ideal Flow (vphpl)	1750	1750	1750	1750	1750	1750	1750	1750	1750	1750	1750	1750
Total Lost time (s)		5.0	5.0		5.0			5.0			5.0	
Lane Util. Factor		1.00	1.00		1.00			0.95			0.95	
Fr _t		1.00	0.85		0.97			0.99			0.99	
Fl _t Protected		0.96	1.00		0.99			0.99			1.00	
Satd. Flow (prot)		1643	1430		1634			3125			3214	
Fl _t Permitted		0.71	1.00		0.89			0.74			0.94	
Satd. Flow (perm)		1213	1430		1476			2318			3036	
Peak-hour factor, PHF	0.72	0.72	0.72	0.72	0.72	0.72	0.72	0.72	0.72	0.72	0.72	0.72
Adj. Flow (vph)	160	39	160	22	47	18	125	510	61	10	628	50
RTOR Reduction (vph)	0	0	115	0	13	0	0	13	0	0	10	0
Lane Group Flow (vph)	0	199	45	0	74	0	0	683	0	0	678	0
Heavy Vehicles (%)	3%	0%	4%	3%	0%	10%	11%	2%	7%	0%	2%	6%
Turn Type	Perm	NA	Perm	Perm	NA		Perm	NA		Perm	NA	
Protected Phases		4			8			2			6	
Permitted Phases	4		4	8			2			6		
Actuated Green, G (s)		12.3	12.3		12.3			21.4			21.4	
Effective Green, g (s)		12.3	12.3		12.3			21.4			21.4	
Actuated g/C Ratio		0.28	0.28		0.28			0.49			0.49	
Clearance Time (s)		5.0	5.0		5.0			5.0			5.0	
Vehicle Extension (s)		3.0	3.0		3.0			3.0			3.0	
Lane Grp Cap (vph)		341	402		415			1135			1486	
v/s Ratio Prot												
v/s Ratio Perm		c0.16	0.03		0.05			c0.29			0.22	
v/c Ratio		0.58	0.11		0.18			0.60			0.46	
Uniform Delay, d1		13.5	11.6		11.9			8.1			7.3	
Progression Factor		1.00	1.00		1.00			1.00			1.00	
Incremental Delay, d2		2.5	0.1		0.2			0.9			0.2	
Delay (s)		16.0	11.8		12.1			9.0			7.5	
Level of Service		B	B		B			A			A	
Approach Delay (s)		14.1			12.1			9.0			7.5	
Approach LOS		B			B			A			A	
Intersection Summary												
HCM 2000 Control Delay			9.6					HCM 2000 Level of Service			A	
HCM 2000 Volume to Capacity ratio			0.59									
Actuated Cycle Length (s)			43.7					Sum of lost time (s)		10.0		
Intersection Capacity Utilization			58.1%					ICU Level of Service		B		
Analysis Period (min)			15									

c Critical Lane Group

HCM Unsignalized Intersection Capacity Analysis

4: Main St & 9th St

12/12/2013

												
Movement	EBL	EBT	EBR	WBL	WBT	WBR	NBL	NBT	NBR	SBL	SBT	SBR
Lane Configurations												
Volume (veh/h)	33	5	95	1	2	4	138	480	29	20	453	74
Sign Control		Stop			Stop			Free			Free	
Grade		0%			0%			0%			0%	
Peak Hour Factor	0.95	0.95	0.95	0.95	0.95	0.95	0.95	0.95	0.95	0.95	0.95	0.95
Hourly flow rate (vph)	35	5	100	1	2	4	145	505	31	21	477	78
Pedestrians												
Lane Width (ft)												
Walking Speed (ft/s)												
Percent Blockage												
Right turn flare (veh)												
Median type	TWLTL								None			
Median storage (veh)	2											
Upstream signal (ft)									283			
pX, platoon unblocked	0.86	0.86	0.86	0.86	0.86		0.86					
vC, conflicting volume	1320	1345	477	1433	1408	521	555			536		
vC1, stage 1 conf vol	519	519		811	811							
vC2, stage 2 conf vol	801	826		622	597							
vCu, unblocked vol	1292	1321	316	1422	1393	521	406			536		
tC, single (s)	7.1	6.5	6.2	7.1	6.5	6.2	4.1			4.1		
tC, 2 stage (s)	6.1	5.5		6.1	5.5							
tF (s)	3.5	4.0	3.3	3.5	4.0	3.3	2.2			2.2		
p0 queue free %	87	98	84	99	99	99	85			98		
cM capacity (veh/h)	265	278	630	207	254	560	991			1042		
Direction, Lane #	EB 1	WB 1	NB 1	NB 2	SB 1	SB 2						
Volume Total	140	7	145	536	498	78						
Volume Left	35	1	145	0	21	0						
Volume Right	100	4	0	31	0	78						
cSH	454	352	991	1700	1042	1700						
Volume to Capacity	0.31	0.02	0.15	0.32	0.02	0.05						
Queue Length 95th (ft)	34	2	13	0	2	0						
Control Delay (s)	16.4	15.4	9.3	0.0	0.6	0.0						
Lane LOS	C	C	A		A							
Approach Delay (s)	16.4	15.4	2.0		0.5							
Approach LOS	C	C										
Intersection Summary												
Average Delay			2.9									
Intersection Capacity Utilization			80.8%		ICU Level of Service				D			
Analysis Period (min)			15									

HCM Unsignalized Intersection Capacity Analysis

5: 7th St & Main St

2/14/2013



Movement	EBL	EBT	EBR	WBL	WBT	WBR	NBL	NBT	NBR	SBL	SBT	SBR
Lane Configurations		↕			↕		↗	↘		↗	↘	
Volume (veh/h)	5	5	15	30	0	205	15	450	60	275	340	5
Sign Control		Stop			Stop			Free			Free	
Grade		0%			0%			0%			0%	
Peak Hour Factor	0.94	0.94	0.94	0.94	0.94	0.94	0.94	0.94	0.94	0.94	0.94	0.94
Hourly flow rate (vph)	5	5	16	32	0	218	16	479	64	293	362	5
Pedestrians					9			1				
Lane Width (ft)					12.0			12.0				
Walking Speed (ft/s)					4.0			4.0				
Percent Blockage					1			0				
Right turn flare (veh)												
Median type								TWLTL			TWLTL	
Median storage veh								2			2	
Upstream signal (ft)											827	
pX, platoon unblocked												
vC, conflicting volume	1678	1533	365	1518	1504	520	367			552		
vC1, stage 1 conf vol	949	949		552	552							
vC2, stage 2 conf vol	729	583		966	952							
vCu, unblocked vol	1678	1533	365	1518	1504	520	367			552		
tC, single (s)	7.1	6.5	6.2	7.1	6.5	6.2	4.2			4.1		
tC, 2 stage (s)	6.1	5.5		6.1	5.5							
tF (s)	3.5	4.0	3.3	3.5	4.0	3.3	2.3			2.2		
p0 queue free %	85	97	98	82	100	60	99			71		
cM capacity (veh/h)	35	167	684	182	210	548	1159			1006		

Direction, Lane #	EB 1	WB 1	NB 1	NB 2	SB 1	SB 2
Volume Total	27	250	16	543	293	367
Volume Left	5	32	16	0	293	0
Volume Right	16	218	0	64	0	5
cSH	128	436	1159	1700	1006	1700
Volume to Capacity	0.21	0.57	0.01	0.32	0.29	0.22
Queue Length 95th (ft)	19	91	1	0	32	0
Control Delay (s)	40.2	23.8	8.1	0.0	10.0	0.0
Lane LOS	E	C	A		B	
Approach Delay (s)	40.2	23.8	0.2		4.5	
Approach LOS	E	C				

Intersection Summary

Average Delay	6.7
Intersection Capacity Utilization	74.9%
ICU Level of Service	D
Analysis Period (min)	15

HCM Unsignalized Intersection Capacity Analysis

6: NE Laughlin Rd & NE Juniper St

2/14/2013



Movement	EBT	EBR	WBL	WBT	NBL	NBR
Lane Configurations	→			←	←	←
Volume (veh/h)	300	30	50	255	25	70
Sign Control	Free			Free	Stop	
Grade	0%			0%	0%	
Peak Hour Factor	0.94	0.94	0.94	0.94	0.94	0.94
Hourly flow rate (vph)	319	32	53	271	27	74
Pedestrians	1			1		
Lane Width (ft)	12.0			12.0		
Walking Speed (ft/s)	4.0			4.0		
Percent Blockage	0			0		
Right turn flare (veh)						
Median type	None			None		
Median storage (veh)						
Upstream signal (ft)						
pX, platoon unblocked						
vC, conflicting volume			351		714	336
vC1, stage 1 conf vol						
vC2, stage 2 conf vol						
vCu, unblocked vol			351		714	336
tC, single (s)			4.1		6.4	6.2
tC, 2 stage (s)						
tF (s)			2.2		3.5	3.3
p0 queue free %			96		93	90
cM capacity (veh/h)			1219		383	710

Direction, Lane #	EB 1	WB 1	NB 1
Volume Total	351	324	101
Volume Left	0	53	27
Volume Right	32	0	74
cSH	1700	1219	580
Volume to Capacity	0.21	0.04	0.17
Queue Length 95th (ft)	0	4	16
Control Delay (s)	0.0	1.7	12.5
Lane LOS		A	B
Approach Delay (s)	0.0	1.7	12.5
Approach LOS			B

Intersection Summary			
Average Delay		2.3	
Intersection Capacity Utilization		53.2%	ICU Level of Service
Analysis Period (min)		15	A

HCM Unsignalized Intersection Capacity Analysis

7: NE Laughlin Rd & S Combs Flat Rd

2/14/2013

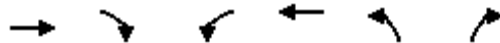

Movement	EBT	EBR	WBL	WBT	NBL	NBR
Lane Configurations	→			←	↔	↔
Volume (veh/h)	145	165	30	85	105	45
Sign Control	Free			Free	Stop	
Grade	0%			0%	0%	
Peak Hour Factor	0.85	0.85	0.85	0.85	0.85	0.85
Hourly flow rate (vph)	171	194	35	100	124	53
Pedestrians					3	
Lane Width (ft)					12.0	
Walking Speed (ft/s)					4.0	
Percent Blockage					0	
Right turn flare (veh)						
Median type	None			None		
Median storage (veh)						
Upstream signal (ft)						
pX, platoon unblocked						
vC, conflicting volume			368		441	271
vC1, stage 1 conf vol						
vC2, stage 2 conf vol						
vCu, unblocked vol			368		441	271
tC, single (s)			4.1		6.4	6.2
tC, 2 stage (s)						
tF (s)			2.2		3.5	3.3
p0 queue free %			97		78	93
cM capacity (veh/h)			1199		553	771

Direction, Lane #	EB 1	WB 1	NB 1
Volume Total	365	135	176
Volume Left	0	35	124
Volume Right	194	0	53
cSH	1700	1199	605
Volume to Capacity	0.21	0.03	0.29
Queue Length 95th (ft)	0	2	31
Control Delay (s)	0.0	2.3	13.4
Lane LOS		A	B
Approach Delay (s)	0.0	2.3	13.4
Approach LOS			B

Intersection Summary			
Average Delay		4.0	
Intersection Capacity Utilization		45.4%	ICU Level of Service
Analysis Period (min)		15	A

HCM Unsignalized Intersection Capacity Analysis

8: 4th St & Main St

2/14/2013



Movement	EBL	EBT	EBR	WBL	WBT	WBR	NBL	NBT	NBR	SBL	SBT	SBR
Lane Configurations		↕			↕		↗	↘		↗	↘	
Volume (veh/h)	25	20	100	30	10	75	40	420	80	65	310	15
Sign Control		Stop			Stop			Free			Free	
Grade		0%			0%			0%			0%	
Peak Hour Factor	0.89	0.89	0.89	0.89	0.89	0.89	0.89	0.89	0.89	0.89	0.89	0.89
Hourly flow rate (vph)	28	22	112	34	11	84	45	472	90	73	348	17
Pedestrians		5			10			6			15	
Lane Width (ft)		12.0			12.0			12.0			12.0	
Walking Speed (ft/s)		4.0			4.0			4.0			4.0	
Percent Blockage		0			1			1			1	
Right turn flare (veh)												
Median type								None			TWLTL	
Median storage veh												2
Upstream signal (ft)								331				
pX, platoon unblocked	0.80	0.80		0.80	0.80	0.80				0.80		
vC, conflicting volume	1174	1169	368	1241	1133	542	370			572		
vC1, stage 1 conf vol	508	508		617	617							
vC2, stage 2 conf vol	667	662		624	516							
vCu, unblocked vol	1092	1085	368	1175	1040	298	370			336		
tC, single (s)	7.1	6.7	6.2	7.2	6.5	6.2	4.2			4.1		
tC, 2 stage (s)	6.1	5.7		6.2	5.5							
tF (s)	3.5	4.1	3.3	3.6	4.0	3.3	2.3			2.2		
p0 queue free %	90	93	83	87	97	86	96			92		
cM capacity (veh/h)	269	300	671	250	350	583	1162			972		

Direction, Lane #	EB 1	WB 1	NB 1	NB 2	SB 1	SB 2
Volume Total	163	129	45	562	73	365
Volume Left	28	34	45	0	73	0
Volume Right	112	84	0	90	0	17
cSH	470	415	1162	1700	972	1700
Volume to Capacity	0.35	0.31	0.04	0.33	0.08	0.21
Queue Length 95th (ft)	40	34	3	0	6	0
Control Delay (s)	16.7	17.6	8.2	0.0	9.0	0.0
Lane LOS	C	C	A		A	
Approach Delay (s)	16.7	17.6	0.6		1.5	
Approach LOS	C	C				

Intersection Summary

Average Delay	4.5
Intersection Capacity Utilization	56.2%
ICU Level of Service	B
Analysis Period (min)	15

HCM Unsignalized Intersection Capacity Analysis

9: NW 9th St & US 26

2/14/2013



Movement	WBL	WBR	NBT	NBR	SBL	SBT
Lane Configurations						
Volume (veh/h)	50	65	195	60	65	185
Sign Control	Stop		Free			Free
Grade	0%		0%			0%
Peak Hour Factor	0.90	0.90	0.90	0.90	0.90	0.90
Hourly flow rate (vph)	56	72	217	67	72	206
Pedestrians	8					
Lane Width (ft)	12.0					
Walking Speed (ft/s)	4.0					
Percent Blockage	1					
Right turn flare (veh)						
Median type			None			None
Median storage (veh)						
Upstream signal (ft)						
pX, platoon unblocked						
vC, conflicting volume	608	258			291	
vC1, stage 1 conf vol						
vC2, stage 2 conf vol						
vCu, unblocked vol	608	258			291	
tC, single (s)	6.5	6.2			4.1	
tC, 2 stage (s)						
tF (s)	3.6	3.3			2.2	
p0 queue free %	87	91			94	
cM capacity (veh/h)	421	768			1251	

Direction, Lane #	WB 1	NB 1	SB 1
Volume Total	128	283	278
Volume Left	56	0	72
Volume Right	72	67	0
cSH	565	1700	1251
Volume to Capacity	0.23	0.17	0.06
Queue Length 95th (ft)	22	0	5
Control Delay (s)	13.2	0.0	2.5
Lane LOS	B		A
Approach Delay (s)	13.2	0.0	2.5
Approach LOS	B		

Intersection Summary			
Average Delay		3.5	
Intersection Capacity Utilization		47.1%	ICU Level of Service A
Analysis Period (min)		15	

Queues

10: US 26 & NW Harwood Ave

2/14/2013

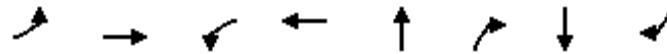

Lane Group	EBL	EBT	WBL	WBT	NBT	NBR	SBT	SBR
Lane Group Flow (vph)	50	789	33	605	111	50	117	61
v/c Ratio	0.24	0.70	0.16	0.59	0.44	0.15	0.45	0.18
Control Delay	37.9	17.6	37.9	15.7	34.5	10.8	34.8	10.2
Queue Delay	0.0	0.0	0.0	0.0	0.0	0.0	0.0	0.0
Total Delay	37.9	17.6	37.9	15.7	34.5	10.8	34.8	10.2
Queue Length 50th (ft)	18	167	12	189	39	0	41	0
Queue Length 95th (ft)	68	#703	51	415	114	31	119	33
Internal Link Dist (ft)		447		993	183		612	
Turn Bay Length (ft)	100		100			75		75
Base Capacity (vph)	299	1319	310	1291	386	474	393	482
Starvation Cap Reductn	0	0	0	0	0	0	0	0
Spillback Cap Reductn	0	0	0	0	0	0	0	0
Storage Cap Reductn	0	0	0	0	0	0	0	0
Reduced v/c Ratio	0.17	0.60	0.11	0.47	0.29	0.11	0.30	0.13

Intersection Summary

95th percentile volume exceeds capacity, queue may be longer.
 Queue shown is maximum after two cycles.

HCM Signalized Intersection Capacity Analysis
 10: US 26 & NW Harwood Ave

2/14/2013



Movement	EBL	EBT	EBR	WBL	WBT	WBR	NBL	NBT	NBR	SBL	SBT	SBR
Lane Configurations												
Volume (vph)	45	690	20	30	480	65	60	40	45	60	45	55
Ideal Flow (vphpl)	1750	1750	1750	1750	1750	1750	1750	1750	1750	1750	1750	1750
Total Lost time (s)	5.0	5.0		5.0	5.0			5.0	5.0		5.0	5.0
Lane Util. Factor	1.00	1.00		1.00	1.00			1.00	1.00		1.00	1.00
Frbp, ped/bikes	1.00	1.00		1.00	1.00			1.00	1.00		1.00	1.00
Flpb, ped/bikes	1.00	1.00		1.00	1.00			1.00	1.00		1.00	1.00
Frt	1.00	1.00		1.00	0.98			1.00	0.85		1.00	0.85
Flt Protected	0.95	1.00		0.95	1.00			0.97	1.00		0.97	1.00
Satd. Flow (prot)	1599	1692		1662	1655			1699	1488		1701	1488
Flt Permitted	0.95	1.00		0.95	1.00			0.75	1.00		0.76	1.00
Satd. Flow (perm)	1599	1692		1662	1655			1309	1488		1332	1488
Peak-hour factor, PHF	0.90	0.90	0.90	0.90	0.90	0.90	0.90	0.90	0.90	0.90	0.90	0.90
Adj. Flow (vph)	50	767	22	33	533	72	67	44	50	67	50	61
RTOR Reduction (vph)	0	1	0	0	5	0	0	0	43	0	0	52
Lane Group Flow (vph)	50	788	0	33	600	0	0	111	7	0	117	9
Confl. Peds. (#/hr)	4		8	8		4						
Heavy Vehicles (%)	4%	3%	0%	0%	4%	0%	0%	0%	0%	0%	0%	0%
Turn Type	Prot			Prot			Perm		Perm	Perm		Perm
Protected Phases	5	2		1	6			8			4	
Permitted Phases							8		8	4		4
Actuated Green, G (s)	4.1	40.3		2.4	38.6			10.0	10.0		10.0	10.0
Effective Green, g (s)	4.1	40.3		2.4	38.6			10.0	10.0		10.0	10.0
Actuated g/C Ratio	0.06	0.60		0.04	0.57			0.15	0.15		0.15	0.15
Clearance Time (s)	5.0	5.0		5.0	5.0			5.0	5.0		5.0	5.0
Vehicle Extension (s)	2.5	3.5		2.5	3.5			2.5	2.5		2.5	2.5
Lane Grp Cap (vph)	97	1007		59	944			193	220		197	220
v/s Ratio Prot	c0.03	c0.47		0.02	0.36							
v/s Ratio Perm								0.08	0.00		c0.09	0.01
v/c Ratio	0.52	0.78		0.56	0.64			0.58	0.03		0.59	0.04
Uniform Delay, d1	30.8	10.4		32.1	9.8			26.9	24.7		27.0	24.7
Progression Factor	1.00	1.00		1.00	1.00			1.00	1.00		1.00	1.00
Incremental Delay, d2	3.4	4.1		8.9	1.5			3.4	0.0		4.0	0.1
Delay (s)	34.3	14.5		41.0	11.3			30.2	24.8		30.9	24.8
Level of Service	C	B		D	B			C	C		C	C
Approach Delay (s)		15.7			12.8			28.5			28.8	
Approach LOS		B			B			C			C	

Intersection Summary		
HCM Average Control Delay	17.1	HCM Level of Service B
HCM Volume to Capacity ratio	0.69	
Actuated Cycle Length (s)	67.7	Sum of lost time (s) 10.0
Intersection Capacity Utilization	64.4%	ICU Level of Service C
Analysis Period (min)	15	
c Critical Lane Group		

Queues

11: US 26 & NW Deer St

2/14/2013

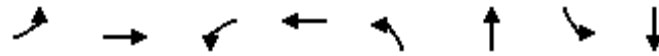

Lane Group	EBL	EBT	WBL	WBT	NBL	NBT	SBL	SBT
Lane Group Flow (vph)	28	861	22	577	83	106	22	94
v/c Ratio	0.06	0.73	0.08	0.49	0.38	0.33	0.10	0.28
Control Delay	5.0	12.4	5.5	7.4	29.6	18.7	25.4	16.1
Queue Delay	0.0	0.0	0.0	0.0	0.0	0.0	0.0	0.0
Total Delay	5.0	12.4	5.5	7.4	29.6	18.7	25.4	16.1
Queue Length 50th (ft)	3	161	2	78	22	16	5	11
Queue Length 95th (ft)	15	493	14	235	89	78	32	65
Internal Link Dist (ft)		993		885		233		1851
Turn Bay Length (ft)	100		100		50		50	
Base Capacity (vph)	624	1575	377	1570	431	597	439	615
Starvation Cap Reductn	0	0	0	0	0	0	0	0
Spillback Cap Reductn	0	0	0	0	0	0	0	0
Storage Cap Reductn	0	0	0	0	0	0	0	0
Reduced v/c Ratio	0.04	0.55	0.06	0.37	0.19	0.18	0.05	0.15

Intersection Summary

HCM Signalized Intersection Capacity Analysis

11: US 26 & NW Deer St

2/14/2013



Movement	EBL	EBT	EBR	WBL	WBT	WBR	NBL	NBT	NBR	SBL	SBT	SBR
Lane Configurations												
Volume (vph)	25	745	30	20	480	40	75	50	45	20	40	45
Ideal Flow (vphpl)	1750	1750	1750	1750	1750	1750	1750	1750	1750	1750	1750	1750
Total Lost time (s)	5.0	5.0		5.0	5.0		5.0	5.0		5.0	5.0	
Lane Util. Factor	1.00	1.00		1.00	1.00		1.00	1.00		1.00	1.00	
Frpb, ped/bikes	1.00	1.00		1.00	1.00		1.00	0.99		1.00	0.99	
Flpb, ped/bikes	1.00	1.00		1.00	1.00		0.99	1.00		0.99	1.00	
Fr _t	1.00	0.99		1.00	0.99		1.00	0.93		1.00	0.92	
Fl _t Protected	0.95	1.00		0.95	1.00		0.95	1.00		0.95	1.00	
Satd. Flow (prot)	1577	1687		1655	1680		1603	1548		1649	1587	
Fl _t Permitted	0.40	1.00		0.23	1.00		0.70	1.00		0.69	1.00	
Satd. Flow (perm)	669	1687		405	1680		1175	1548		1196	1587	
Peak-hour factor, PHF	0.90	0.90	0.90	0.90	0.90	0.90	0.90	0.90	0.90	0.90	0.90	0.90
Adj. Flow (vph)	28	828	33	22	533	44	83	56	50	22	44	50
RTOR Reduction (vph)	0	2	0	0	4	0	0	37	0	0	42	0
Lane Group Flow (vph)	28	859	0	22	573	0	83	69	0	22	52	0
Confl. Peds. (#/hr)	7		15	15		7	6		7	7		6
Heavy Vehicles (%)	5%	3%	3%	0%	3%	0%	3%	5%	2%	0%	0%	0%
Turn Type	Perm		Perm		Perm		Perm		Perm		Perm	
Protected Phases	2		6		6		8		8		4	
Permitted Phases	2		6		6		8		8		4	
Actuated Green, G (s)	36.5	36.5		36.5	36.5		8.3	8.3		8.3	8.3	
Effective Green, g (s)	36.5	36.5		36.5	36.5		8.3	8.3		8.3	8.3	
Actuated g/C Ratio	0.67	0.67		0.67	0.67		0.15	0.15		0.15	0.15	
Clearance Time (s)	5.0	5.0		5.0	5.0		5.0	5.0		5.0	5.0	
Vehicle Extension (s)	3.0	3.0		3.0	3.0		2.5	2.5		2.5	2.5	
Lane Grp Cap (vph)	446	1124		270	1119		178	234		181	240	
v/s Ratio Prot		c0.51			0.34			0.04			0.03	
v/s Ratio Perm	0.04			0.05			c0.07			0.02		
v/c Ratio	0.06	0.76		0.08	0.51		0.47	0.29		0.12	0.21	
Uniform Delay, d ₁	3.2	6.2		3.2	4.6		21.2	20.6		20.1	20.4	
Progression Factor	1.00	1.00		1.00	1.00		1.00	1.00		1.00	1.00	
Incremental Delay, d ₂	0.1	3.2		0.1	0.4		1.4	0.5		0.2	0.3	
Delay (s)	3.2	9.4		3.4	5.0		22.6	21.2		20.3	20.7	
Level of Service	A	A		A	A		C	C		C	C	
Approach Delay (s)		9.2			5.0			21.8			20.6	
Approach LOS		A			A			C			C	

Intersection Summary

HCM Average Control Delay	9.8	HCM Level of Service	A
HCM Volume to Capacity ratio	0.71		
Actuated Cycle Length (s)	54.8	Sum of lost time (s)	10.0
Intersection Capacity Utilization	65.4%	ICU Level of Service	C
Analysis Period (min)	15		
c Critical Lane Group			

Queues

12: US 26 & Main St

2/14/2013



Lane Group	EBL	EBT	WBL	WBT	NBL	NBT	SBL	SBT
Lane Group Flow (vph)	204	682	108	500	151	306	102	366
v/c Ratio	0.61	0.95	0.47	0.78	0.88	0.76	0.45	0.99
Control Delay	18.2	48.3	16.8	32.1	73.0	45.9	30.1	80.0
Queue Delay	0.0	0.0	0.0	0.0	0.0	0.0	0.0	0.0
Total Delay	18.2	48.3	16.8	32.1	73.0	45.9	30.1	80.0
Queue Length 50th (ft)	52	349	26	227	65	168	43	~226
Queue Length 95th (ft)	102	#676	56	386	#167	#315	85	#393
Internal Link Dist (ft)		885		1205		239		251
Turn Bay Length (ft)	100		100		75		75	
Base Capacity (vph)	354	755	287	757	172	405	228	369
Starvation Cap Reductn	0	0	0	0	0	0	0	0
Spillback Cap Reductn	0	0	0	0	0	0	0	0
Storage Cap Reductn	0	0	0	0	0	0	0	0
Reduced v/c Ratio	0.58	0.90	0.38	0.66	0.88	0.76	0.45	0.99

Intersection Summary

~ Volume exceeds capacity, queue is theoretically infinite.
 Queue shown is maximum after two cycles.

95th percentile volume exceeds capacity, queue may be longer.
 Queue shown is maximum after two cycles.

HCM Signalized Intersection Capacity Analysis

12: US 26 & Main St

2/14/2013



Movement	EBL	EBT	EBR	WBL	WBT	WBR	NBL	NBT	NBR	SBL	SBT	SBR
Lane Configurations												
Volume (vph)	190	470	165	100	360	105	140	240	45	95	240	100
Ideal Flow (vphpl)	1750	1750	1750	1750	1750	1750	1750	1750	1750	1750	1750	1750
Total Lost time (s)	5.0	5.0		5.0	5.0		5.0	5.0		5.0	5.0	
Lane Util. Factor	1.00	1.00		1.00	1.00		1.00	1.00		1.00	1.00	
Frpb, ped/bikes	1.00	0.99		1.00	0.99		1.00	0.99		1.00	0.99	
Flpb, ped/bikes	1.00	1.00		1.00	1.00		1.00	1.00		1.00	1.00	
Fr t	1.00	0.96		1.00	0.97		1.00	0.98		1.00	0.96	
Fl t Protected	0.95	1.00		0.95	1.00		0.95	1.00		0.95	1.00	
Satd. Flow (prot)	1613	1631		1662	1641		1614	1637		1626	1646	
Fl t Permitted	0.24	1.00		0.13	1.00		0.19	1.00		0.36	1.00	
Satd. Flow (perm)	400	1631		231	1641		330	1637		612	1646	
Peak-hour factor, PHF	0.93	0.93	0.93	0.93	0.93	0.93	0.93	0.93	0.93	0.93	0.93	0.93
Adj. Flow (vph)	204	505	177	108	387	113	151	258	48	102	258	108
RTOR Reduction (vph)	0	14	0	0	12	0	0	7	0	0	16	0
Lane Group Flow (vph)	204	668	0	108	488	0	151	299	0	102	350	0
Confl. Peds. (#/hr)	6		2	2		6	2		7	7		2
Confl. Bikes (#/hr)						2						
Heavy Vehicles (%)	3%	3%	1%	0%	2%	3%	3%	4%	3%	2%	0%	3%
Turn Type	pm+pt			pm+pt			pm+pt			pm+pt		
Protected Phases	5	2		1	6		3	8		7	4	
Permitted Phases	2			6			8			4		
Actuated Green, G (s)	45.6	36.6		39.4	33.5		25.7	20.6		23.1	19.3	
Effective Green, g (s)	45.6	36.6		39.4	33.5		25.7	20.6		23.1	19.3	
Actuated g/C Ratio	0.52	0.42		0.45	0.39		0.30	0.24		0.27	0.22	
Clearance Time (s)	5.0	5.0		5.0	5.0		5.0	5.0		5.0	5.0	
Vehicle Extension (s)	2.0	3.0		2.0	4.0		2.0	2.0		2.0	2.0	
Lane Grp Cap (vph)	336	687		202	633		173	388		207	366	
v/s Ratio Prot	c0.06	c0.41		0.04	0.30		c0.05	0.18		0.02	c0.21	
v/s Ratio Perm	0.26			0.21			0.21			0.11		
v/c Ratio	0.61	0.97		0.53	0.77		0.87	0.77		0.49	0.96	
Uniform Delay, d1	13.9	24.7		17.3	23.3		27.3	30.9		26.0	33.4	
Progression Factor	1.00	1.00		1.00	1.00		1.00	1.00		1.00	1.00	
Incremental Delay, d2	2.1	27.4		1.4	6.1		34.2	8.4		0.7	35.0	
Delay (s)	16.0	52.1		18.7	29.4		61.5	39.3		26.7	68.3	
Level of Service	B	D		B	C		E	D		C	E	
Approach Delay (s)		43.8			27.5			46.7			59.3	
Approach LOS		D			C			D			E	

Intersection Summary

HCM Average Control Delay	43.2	HCM Level of Service	D
HCM Volume to Capacity ratio	0.95		
Actuated Cycle Length (s)	86.9	Sum of lost time (s)	20.0
Intersection Capacity Utilization	89.3%	ICU Level of Service	E
Analysis Period (min)	15		

c Critical Lane Group

Queues

13: US 26 & N Elm St

2/14/2013

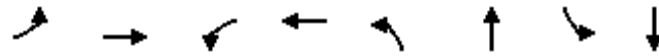

Lane Group	EBL	EBT	WBL	WBT	NBL	NBT	SBL	SBT
Lane Group Flow (vph)	11	645	11	555	33	78	94	45
v/c Ratio	0.03	0.60	0.03	0.51	0.13	0.21	0.35	0.12
Control Delay	6.0	10.5	6.1	9.1	17.4	10.1	20.5	12.7
Queue Delay	0.0	0.0	0.0	0.0	0.0	0.0	0.0	0.0
Total Delay	6.0	10.5	6.1	9.1	17.4	10.1	20.5	12.7
Queue Length 50th (ft)	1	90	1	71	6	5	18	5
Queue Length 95th (ft)	9	303	9	239	31	39	70	32
Internal Link Dist (ft)		1205		1506		316		433
Turn Bay Length (ft)	75		75		50		50	
Base Capacity (vph)	597	1656	574	1661	551	750	575	783
Starvation Cap Reductn	0	0	0	0	0	0	0	0
Spillback Cap Reductn	0	0	0	0	0	0	0	0
Storage Cap Reductn	0	0	0	0	0	0	0	0
Reduced v/c Ratio	0.02	0.39	0.02	0.33	0.06	0.10	0.16	0.06

Intersection Summary

HCM Signalized Intersection Capacity Analysis

13: US 26 & N Elm St

2/14/2013



Movement	EBL	EBT	EBR	WBL	WBT	WBR	NBL	NBT	NBR	SBL	SBT	SBR
Lane Configurations	↖	↗		↖	↗		↖	↗		↖	↗	
Volume (vph)	10	565	15	10	490	10	30	25	45	85	25	15
Ideal Flow (vphpl)	1750	1750	1750	1750	1750	1750	1750	1750	1750	1750	1750	1750
Total Lost time (s)	5.0	5.0		5.0	5.0		5.0	5.0		5.0	5.0	
Lane Util. Factor	1.00	1.00		1.00	1.00		1.00	1.00		1.00	1.00	
Frbp, ped/bikes	1.00	1.00		1.00	1.00		1.00	0.98		1.00	0.99	
Flpb, ped/bikes	1.00	1.00		1.00	1.00		0.99	1.00		0.99	1.00	
Frt	1.00	1.00		1.00	1.00		1.00	0.90		1.00	0.94	
Flt Protected	0.95	1.00		0.95	1.00		0.95	1.00		0.95	1.00	
Satd. Flow (prot)	1452	1705		1659	1710		1524	1527		1635	1631	
Flt Permitted	0.40	1.00		0.34	1.00		0.73	1.00		0.71	1.00	
Satd. Flow (perm)	617	1705		592	1710		1167	1527		1216	1631	
Peak-hour factor, PHF	0.90	0.90	0.90	0.90	0.90	0.90	0.90	0.90	0.90	0.90	0.90	0.90
Adj. Flow (vph)	11	628	17	11	544	11	33	28	50	94	28	17
RTOR Reduction (vph)	0	1	0	0	1	0	0	41	0	0	14	0
Lane Group Flow (vph)	11	644	0	11	554	0	33	37	0	94	31	0
Confl. Peds. (#/hr)	10		5	5		10	10		7	7		10
Confl. Bikes (#/hr)												1
Heavy Vehicles (%)	14%	2%	8%	0%	2%	0%	8%	5%	0%	1%	0%	0%
Turn Type	Perm			Perm			Perm			Perm		
Protected Phases		2			6			8			4	
Permitted Phases	2			6			8			4		
Actuated Green, G (s)	26.5	26.5		26.5	26.5		8.1	8.1		8.1	8.1	
Effective Green, g (s)	26.5	26.5		26.5	26.5		8.1	8.1		8.1	8.1	
Actuated g/C Ratio	0.59	0.59		0.59	0.59		0.18	0.18		0.18	0.18	
Clearance Time (s)	5.0	5.0		5.0	5.0		5.0	5.0		5.0	5.0	
Vehicle Extension (s)	3.5	3.5		3.5	3.5		2.5	2.5		2.5	2.5	
Lane Grp Cap (vph)	367	1013		352	1016		212	277		221	296	
v/s Ratio Prot		c0.38			0.32			0.02			0.02	
v/s Ratio Perm	0.02			0.02			0.03			c0.08		
v/c Ratio	0.03	0.64		0.03	0.55		0.16	0.13		0.43	0.11	
Uniform Delay, d1	3.7	5.9		3.7	5.4		15.4	15.3		16.2	15.2	
Progression Factor	1.00	1.00		1.00	1.00		1.00	1.00		1.00	1.00	
Incremental Delay, d2	0.0	1.4		0.0	0.7		0.3	0.2		1.0	0.1	
Delay (s)	3.8	7.3		3.8	6.1		15.6	15.5		17.1	15.3	
Level of Service	A	A		A	A		B	B		B	B	
Approach Delay (s)		7.2			6.1			15.5			16.6	
Approach LOS		A			A			B			B	

Intersection Summary

HCM Average Control Delay	8.3	HCM Level of Service	A
HCM Volume to Capacity ratio	0.59		
Actuated Cycle Length (s)	44.6	Sum of lost time (s)	10.0
Intersection Capacity Utilization	55.0%	ICU Level of Service	B
Analysis Period (min)	15		

c Critical Lane Group

HCM Unsignalized Intersection Capacity Analysis
 14: US 26 & NE Juniper St

2/14/2013



Movement	EBL	EBT	EBR	WBL	WBT	WBR	NBL	NBT	NBR	SBL	SBT	SBR
Lane Configurations												
Volume (veh/h)	65	680	5	5	495	25	5	5	5	35	5	40
Sign Control		Free			Free			Stop			Stop	
Grade		0%			0%			0%			0%	
Peak Hour Factor	0.90	0.90	0.90	0.90	0.90	0.90	0.90	0.90	0.90	0.90	0.90	0.90
Hourly flow rate (vph)	72	756	6	6	550	28	6	6	6	39	6	44
Pedestrians		1			9			11			6	
Lane Width (ft)		12.0			12.0			12.0			12.0	
Walking Speed (ft/s)		4.0			4.0			4.0			4.0	
Percent Blockage		0			1			1			1	
Right turn flare (veh)												
Median type		TWLTL			TWLTL							
Median storage (veh)		2			2							
Upstream signal (ft)												
pX, platoon unblocked												
vC, conflicting volume	584			772			1523	1509	778	1498	1498	571
vC1, stage 1 conf vol							914	914		581	581	
vC2, stage 2 conf vol							609	595		917	917	
vCu, unblocked vol	584			772			1523	1509	778	1498	1498	571
tC, single (s)	4.1			4.3			7.1	6.5	6.2	7.3	7.0	6.2
tC, 2 stage (s)							6.1	5.5		6.3	6.0	
tF (s)	2.2			2.4			3.5	4.0	3.3	3.7	4.5	3.3
p0 queue free %	93			99			98	98	99	84	98	91
cM capacity (veh/h)	976			773			240	271	393	237	231	521

Direction, Lane #	EB 1	EB 2	WB 1	WB 2	NB 1	SB 1
Volume Total	72	761	6	578	17	89
Volume Left	72	0	6	0	6	39
Volume Right	0	6	0	28	6	44
cSH	976	1700	773	1700	288	325
Volume to Capacity	0.07	0.45	0.01	0.34	0.06	0.27
Queue Length 95th (ft)	6	0	1	0	5	28
Control Delay (s)	9.0	0.0	9.7	0.0	18.3	20.2
Lane LOS	A		A		C	C
Approach Delay (s)	0.8		0.1		18.3	20.2
Approach LOS					C	C

Intersection Summary		
Average Delay		1.8
Intersection Capacity Utilization	60.2%	ICU Level of Service
Analysis Period (min)		15
		B

HCM Unsignalized Intersection Capacity Analysis
 15: US 26 & NE Knowledge St

2/14/2013



Movement	EBT	EBR	WBL	WBT	NBL	NBR
Lane Configurations	↩		↩	↩	↩	↩
Volume (veh/h)	535	5	5	640	5	5
Sign Control	Free			Free	Stop	
Grade	0%			0%	0%	
Peak Hour Factor	0.91	0.91	0.91	0.91	0.91	0.91
Hourly flow rate (vph)	588	5	5	703	5	5
Pedestrians					6	
Lane Width (ft)					12.0	
Walking Speed (ft/s)					4.0	
Percent Blockage					1	
Right turn flare (veh)						
Median type	TWLTL			TWLTL		
Median storage veh	2			2		
Upstream signal (ft)						
pX, platoon unblocked						
vC, conflicting volume			599		1311	597
vC1, stage 1 conf vol					597	
vC2, stage 2 conf vol					714	
vCu, unblocked vol			599		1311	597
tC, single (s)			4.1		6.4	6.2
tC, 2 stage (s)					5.4	
tF (s)			2.2		3.5	3.3
p0 queue free %			99		99	99
cM capacity (veh/h)			983		392	504

Direction, Lane #	EB 1	WB 1	WB 2	NB 1
Volume Total	593	5	703	11
Volume Left	0	5	0	5
Volume Right	5	0	0	5
cSH	1700	983	1700	441
Volume to Capacity	0.35	0.01	0.41	0.02
Queue Length 95th (ft)	0	0	0	2
Control Delay (s)	0.0	8.7	0.0	13.4
Lane LOS		A		B
Approach Delay (s)	0.0	0.1		13.4
Approach LOS				B

Intersection Summary			
Average Delay		0.1	
Intersection Capacity Utilization	46.6%		ICU Level of Service A
Analysis Period (min)	15		

Queues

16: US 26 & S Combs Flat Rd

2/14/2013



Lane Group	EBL	EBT	WBL	WBT	NBT	SBT
Lane Group Flow (vph)	76	532	87	429	386	277
v/c Ratio	0.47	0.82	0.51	0.64	0.83	0.53
Control Delay	49.3	32.0	50.2	23.6	46.6	30.1
Queue Delay	0.0	0.0	0.0	0.0	0.0	0.0
Total Delay	49.3	32.0	50.2	23.6	46.6	30.1
Queue Length 50th (ft)	40	245	46	178	196	122
Queue Length 95th (ft)	98	376	#111	281	#474	259
Internal Link Dist (ft)		1816		4182	3042	696
Turn Bay Length (ft)	100		150			
Base Capacity (vph)	213	1176	205	1213	463	523
Starvation Cap Reductn	0	0	0	0	0	0
Spillback Cap Reductn	0	0	0	0	0	0
Storage Cap Reductn	0	0	0	0	0	0
Reduced v/c Ratio	0.36	0.45	0.42	0.35	0.83	0.53

Intersection Summary

95th percentile volume exceeds capacity, queue may be longer.
Queue shown is maximum after two cycles.

HCM Signalized Intersection Capacity Analysis

16: US 26 & S Combs Flat Rd

2/14/2013



Movement	EBL	EBT	EBR	WBL	WBT	WBR	NBL	NBT	NBR	SBL	SBT	SBR
Lane Configurations												
Volume (vph)	70	335	155	80	325	70	85	205	65	40	180	35
Ideal Flow (vphpl)	1750	1750	1750	1750	1750	1750	1750	1750	1750	1750	1750	1750
Total Lost time (s)	5.0	5.0		5.0	5.0			5.0			5.0	
Lane Util. Factor	1.00	1.00		1.00	1.00			1.00			1.00	
Frbp, ped/bikes	1.00	0.99		1.00	1.00			1.00			1.00	
Flpb, ped/bikes	1.00	1.00		1.00	1.00			1.00			1.00	
Frt	1.00	0.95		1.00	0.97			0.98			0.98	
Flt Protected	0.95	1.00		0.95	1.00			0.99			0.99	
Satd. Flow (prot)	1662	1597		1599	1655			1576			1658	
Flt Permitted	0.95	1.00		0.95	1.00			0.83			0.90	
Satd. Flow (perm)	1662	1597		1599	1655			1319			1498	
Peak-hour factor, PHF	0.92	0.92	0.92	0.92	0.92	0.92	0.92	0.92	0.92	0.92	0.92	0.92
Adj. Flow (vph)	76	364	168	87	353	76	92	223	71	43	196	38
RTOR Reduction (vph)	0	19	0	0	9	0	0	7	0	0	5	0
Lane Group Flow (vph)	76	513	0	87	420	0	0	379	0	0	272	0
Confl. Peds. (#/hr)	2		1	1		2	4					4
Confl. Bikes (#/hr)			1			2			1			
Heavy Vehicles (%)	0%	3%	5%	4%	3%	0%	11%	6%	2%	3%	2%	4%
Turn Type	Prot			Prot			Perm			Perm		
Protected Phases	5	2		1	6			8			4	
Permitted Phases							8			4		
Actuated Green, G (s)	6.4	32.2		6.9	32.7			28.2			28.2	
Effective Green, g (s)	6.4	32.2		6.9	32.7			28.2			28.2	
Actuated g/C Ratio	0.08	0.39		0.08	0.40			0.34			0.34	
Clearance Time (s)	5.0	5.0		5.0	5.0			5.0			5.0	
Vehicle Extension (s)	2.0	4.5		2.5	4.5			2.8			2.8	
Lane Grp Cap (vph)	129	625		134	658			452			513	
v/s Ratio Prot	0.05	c0.32		c0.05	0.25							
v/s Ratio Perm								c0.29			0.18	
v/c Ratio	0.59	0.82		0.65	0.64			0.84			0.53	
Uniform Delay, d1	36.7	22.5		36.5	20.0			25.0			21.7	
Progression Factor	1.00	1.00		1.00	1.00			1.00			1.00	
Incremental Delay, d2	4.4	9.2		9.2	2.5			12.8			1.0	
Delay (s)	41.1	31.7		45.7	22.6			37.7			22.7	
Level of Service	D	C		D	C			D			C	
Approach Delay (s)		32.9			26.5			37.7			22.7	
Approach LOS		C			C			D			C	

Intersection Summary

HCM Average Control Delay	30.5	HCM Level of Service	C
HCM Volume to Capacity ratio	0.81		
Actuated Cycle Length (s)	82.3	Sum of lost time (s)	15.0
Intersection Capacity Utilization	80.0%	ICU Level of Service	D
Analysis Period (min)	15		

c Critical Lane Group

HCM Unsignalized Intersection Capacity Analysis
 17: US 26 & NE Laughlin Rd

2/14/2013



Movement	EBL	EBT	EBR	WBL	WBT	WBR	NBL	NBT	NBR	SBL	SBT	SBR
Lane Configurations	↗	↘		↗	↘			↕			↕	
Volume (veh/h)	5	210	25	5	170	30	25	10	5	30	5	10
Sign Control		Free			Free			Stop			Stop	
Grade		0%			0%			0%			0%	
Peak Hour Factor	0.90	0.90	0.90	0.90	0.90	0.90	0.90	0.90	0.90	0.90	0.90	0.90
Hourly flow rate (vph)	6	233	28	6	189	33	28	11	6	33	6	11
Pedestrians								1			1	
Lane Width (ft)								12.0			12.0	
Walking Speed (ft/s)								4.0			4.0	
Percent Blockage								0			0	
Right turn flare (veh)												
Median type		TWLTL			None							
Median storage (veh)		2										
Upstream signal (ft)												
pX, platoon unblocked												
vC, conflicting volume	190			262			473	460	248	473	491	207
vC1, stage 1 conf vol							259	259		218	218	
vC2, stage 2 conf vol							214	201		256	273	
vCu, unblocked vol	190			262			473	460	248	473	491	207
tC, single (s)	4.1			4.1			7.1	6.5	6.2	7.2	6.5	6.2
tC, 2 stage (s)							6.1	5.5		6.2	5.5	
tF (s)	2.2			2.2			3.5	4.0	3.3	3.6	4.0	3.3
p0 queue free %	100			100			96	98	99	95	99	99
cM capacity (veh/h)	1395			1313			652	623	795	637	609	838

Direction, Lane #	EB 1	EB 2	WB 1	WB 2	NB 1	SB 1
Volume Total	6	261	6	222	44	50
Volume Left	6	0	6	0	28	33
Volume Right	0	28	0	33	6	11
cSH	1395	1700	1313	1700	659	670
Volume to Capacity	0.00	0.15	0.00	0.13	0.07	0.07
Queue Length 95th (ft)	0	0	0	0	6	6
Control Delay (s)	7.6	0.0	7.8	0.0	10.9	10.8
Lane LOS	A		A		B	B
Approach Delay (s)	0.2		0.2		10.9	10.8
Approach LOS					B	B

Intersection Summary		
Average Delay		1.9
Intersection Capacity Utilization	23.7%	ICU Level of Service
Analysis Period (min)		15
		A

HCM Unsignalized Intersection Capacity Analysis
 18: 2nd St & Meadowlakes Dr

2/14/2013



Movement	EBL	EBT	EBR	WBL	WBT	WBR	NBL	NBT	NBR	SBL	SBT	SBR
Lane Configurations		↕			↕			↕			↕	
Volume (veh/h)	10	255	25	35	20	15	5	25	40	15	20	15
Sign Control		Free			Free			Stop			Stop	
Grade		0%			0%			0%			0%	
Peak Hour Factor	0.85	0.85	0.85	0.85	0.85	0.85	0.85	0.85	0.85	0.85	0.85	0.85
Hourly flow rate (vph)	12	300	29	41	24	18	6	29	47	18	24	18
Pedestrians		10			2			4			7	
Lane Width (ft)		12.0			12.0			12.0			12.0	
Walking Speed (ft/s)		4.0			4.0			4.0			4.0	
Percent Blockage		1			0			0			1	
Right turn flare (veh)												
Median type		None			None							
Median storage (veh)												
Upstream signal (ft)		919										
pX, platoon unblocked												
vC, conflicting volume	48			333			496	473	321	524	479	49
vC1, stage 1 conf vol												
vC2, stage 2 conf vol												
vCu, unblocked vol	48			333			496	473	321	524	479	49
tC, single (s)	4.1			4.1			7.1	6.5	6.2	7.2	6.5	6.3
tC, 2 stage (s)												
tF (s)	2.2			2.2			3.5	4.0	3.3	3.6	4.0	3.4
p0 queue free %	99			97			99	94	93	95	95	98
cM capacity (veh/h)	1563			1211			437	468	714	386	465	977

Direction, Lane #	EB 1	WB 1	NB 1	SB 1
Volume Total	341	82	82	59
Volume Left	12	41	6	18
Volume Right	29	18	47	18
cSH	1563	1211	579	514
Volume to Capacity	0.01	0.03	0.14	0.11
Queue Length 95th (ft)	1	3	13	10
Control Delay (s)	0.3	4.2	12.2	12.9
Lane LOS	A	A	B	B
Approach Delay (s)	0.3	4.2	12.2	12.9
Approach LOS			B	B

Intersection Summary			
Average Delay		3.9	
Intersection Capacity Utilization		39.2%	ICU Level of Service
Analysis Period (min)		15	A

HCM Unsignalized Intersection Capacity Analysis

19: 2nd St & NW Deer St

2/14/2013



Movement	EBL	EBT	EBR	WBL	WBT	WBR	NBL	NBT	NBR	SBL	SBT	SBR
Lane Configurations		↔			↔		↗	↘		↗	↘	
Volume (veh/h)	35	135	90	10	65	55	35	70	10	20	60	15
Sign Control		Stop			Stop			Free			Free	
Grade		0%			0%			0%			0%	
Peak Hour Factor	0.85	0.85	0.85	0.85	0.85	0.85	0.85	0.85	0.85	0.85	0.85	0.85
Hourly flow rate (vph)	41	159	106	12	76	65	41	82	12	24	71	18
Pedestrians		8			7			2			5	
Lane Width (ft)		12.0			12.0			12.0			12.0	
Walking Speed (ft/s)		4.0			4.0			4.0			4.0	
Percent Blockage		1			1			0			0	
Right turn flare (veh)												
Median type								None			None	
Median storage (veh)												
Upstream signal (ft)												313
pX, platoon unblocked												
vC, conflicting volume	407	318	89	483	321	100	96			101		
vC1, stage 1 conf vol												
vC2, stage 2 conf vol												
vCu, unblocked vol	407	318	89	483	321	100	96			101		
tC, single (s)	7.1	6.5	6.2	7.1	6.5	6.2	4.1			4.2		
tC, 2 stage (s)												
tF (s)	3.5	4.0	3.3	3.5	4.0	3.3	2.2			2.3		
p0 queue free %	91	72	89	96	86	93	97			98		
cM capacity (veh/h)	436	562	966	330	563	946	1475			1458		

Direction, Lane #	EB 1	WB 1	NB 1	NB 2	SB 1	SB 2
Volume Total	306	153	41	94	24	88
Volume Left	41	12	41	0	24	0
Volume Right	106	65	0	12	0	18
cSH	629	638	1475	1700	1458	1700
Volume to Capacity	0.49	0.24	0.03	0.06	0.02	0.05
Queue Length 95th (ft)	69	24	2	0	1	0
Control Delay (s)	16.0	12.4	7.5	0.0	7.5	0.0
Lane LOS	C	B	A		A	
Approach Delay (s)	16.0	12.4	2.3		1.6	
Approach LOS	C	B				

Intersection Summary		
Average Delay		10.3
Intersection Capacity Utilization	38.9%	ICU Level of Service
Analysis Period (min)		15
		A

HCM Unsignalized Intersection Capacity Analysis

20: 2nd St & Main St

2/14/2013



Movement	EBL	EBT	EBR	WBL	WBT	WBR	NBL	NBT	NBR	SBL	SBT	SBR
Lane Configurations		↕			↕		↗	↘		↗	↘	
Volume (veh/h)	45	25	100	5	20	55	75	320	10	30	380	60
Sign Control		Stop			Stop			Free			Free	
Grade		0%			0%			0%			0%	
Peak Hour Factor	0.89	0.89	0.89	0.89	0.89	0.89	0.89	0.89	0.89	0.89	0.89	0.89
Hourly flow rate (vph)	51	28	112	6	22	62	84	360	11	34	427	67
Pedestrians		9			8			2			11	
Lane Width (ft)		12.0			12.0			12.0			12.0	
Walking Speed (ft/s)		4.0			4.0			4.0			4.0	
Percent Blockage		1			1			0			1	
Right turn flare (veh)												
Median type								None			None	
Median storage (veh)												
Upstream signal (ft)												319
pX, platoon unblocked	0.87	0.87	0.87	0.87	0.87		0.87					
vC, conflicting volume	1149	1084	472	1164	1113	384	503			379		
vC1, stage 1 conf vol												
vC2, stage 2 conf vol												
vCu, unblocked vol	1095	1021	314	1113	1053	384	350			379		
tC, single (s)	7.1	6.5	6.2	7.1	6.6	6.2	4.1			4.1		
tC, 2 stage (s)												
tF (s)	3.5	4.0	3.3	3.5	4.1	3.3	2.2			2.2		
p0 queue free %	58	85	82	95	87	91	92			97		
cM capacity (veh/h)	122	182	620	106	167	657	1049			1183		

Direction, Lane #	EB 1	WB 1	NB 1	NB 2	SB 1	SB 2
Volume Total	191	90	84	371	34	494
Volume Left	51	6	84	0	34	0
Volume Right	112	62	0	11	0	67
cSH	254	319	1049	1700	1183	1700
Volume to Capacity	0.75	0.28	0.08	0.22	0.03	0.29
Queue Length 95th (ft)	140	29	7	0	2	0
Control Delay (s)	52.2	20.7	8.7	0.0	8.1	0.0
Lane LOS	F	C	A		A	
Approach Delay (s)	52.2	20.7	1.6		0.5	
Approach LOS	F	C				

Intersection Summary

Average Delay	10.2
Intersection Capacity Utilization	57.9%
ICU Level of Service	B
Analysis Period (min)	15

HCM Unsignalized Intersection Capacity Analysis

21: S 5th St & Main St

2/14/2013



Movement	WBL	WBR	NBT	NBR	SBL	SBT
Lane Configurations						
Volume (veh/h)	5	40	220	5	45	420
Sign Control	Stop		Free			Free
Grade	0%		0%			0%
Peak Hour Factor	0.89	0.89	0.89	0.89	0.89	0.89
Hourly flow rate (vph)	6	45	247	6	51	472
Pedestrians	3					
Lane Width (ft)	12.0					
Walking Speed (ft/s)	4.0					
Percent Blockage	0					
Right turn flare (veh)						
Median type			None			None
Median storage (veh)						
Upstream signal (ft)						
pX, platoon unblocked						
vC, conflicting volume	826	253			256	
vC1, stage 1 conf vol						
vC2, stage 2 conf vol						
vCu, unblocked vol	826	253			256	
tC, single (s)	6.4	6.2			4.2	
tC, 2 stage (s)						
tF (s)	3.5	3.3			2.3	
p0 queue free %	98	94			96	
cM capacity (veh/h)	330	781			1277	

Direction, Lane #	WB 1	NB 1	SB 1
Volume Total	51	253	522
Volume Left	6	0	51
Volume Right	45	6	0
cSH	678	1700	1277
Volume to Capacity	0.07	0.15	0.04
Queue Length 95th (ft)	6	0	3
Control Delay (s)	10.7	0.0	1.2
Lane LOS	B		A
Approach Delay (s)	10.7	0.0	1.2
Approach LOS	B		

Intersection Summary			
Average Delay		1.4	
Intersection Capacity Utilization		53.0%	ICU Level of Service A
Analysis Period (min)		15	

HCM Unsignalized Intersection Capacity Analysis

22: SE Lynn Blvd & Main St

2/14/2013



Movement	EBL	EBT	EBR	WBL	WBT	WBR	NBL	NBT	NBR	SBL	SBT	SBR
Lane Configurations		↔			↔			↔		↔	↔	
Volume (veh/h)	35	15	20	60	5	250	5	50	30	270	115	5
Sign Control		Stop			Stop			Free			Free	
Grade		0%			0%			0%			0%	
Peak Hour Factor	0.87	0.87	0.87	0.87	0.87	0.87	0.87	0.87	0.87	0.87	0.87	0.87
Hourly flow rate (vph)	40	17	23	69	6	287	6	57	34	310	132	6
Pedestrians												
Lane Width (ft)												
Walking Speed (ft/s)												
Percent Blockage												
Right turn flare (veh)												
Median type								None			None	
Median storage (veh)												
Upstream signal (ft)												
pX, platoon unblocked												
vC, conflicting volume	1132	859	135	871	845	75	138			92		
vC1, stage 1 conf vol												
vC2, stage 2 conf vol												
vCu, unblocked vol	1132	859	135	871	845	75	138			92		
tC, single (s)	7.1	6.5	6.2	7.2	6.5	6.2	4.1			4.1		
tC, 2 stage (s)												
tF (s)	3.5	4.0	3.3	3.6	4.0	3.3	2.2			2.2		
p0 queue free %	62	93	97	67	98	71	100			79		
cM capacity (veh/h)	106	234	919	206	239	990	1458			1509		

Direction, Lane #	EB 1	WB 1	NB 1	SB 1	SB 2
Volume Total	80	362	98	310	138
Volume Left	40	69	6	310	0
Volume Right	23	287	34	0	6
cSH	169	558	1458	1509	1700
Volume to Capacity	0.48	0.65	0.00	0.21	0.08
Queue Length 95th (ft)	59	121	0	20	0
Control Delay (s)	44.4	22.6	0.5	8.0	0.0
Lane LOS	E	C	A	A	
Approach Delay (s)	44.4	22.6	0.5	5.5	
Approach LOS	E	C			

Intersection Summary

Average Delay	14.5
Intersection Capacity Utilization	50.9%
ICU Level of Service	A
Analysis Period (min)	15

HCM Unsignalized Intersection Capacity Analysis
 23: SE Lynn Blvd & S Fairview St

2/14/2013



Movement	EBL	EBT	WBT	WBR	SBL	SBR
Lane Configurations		↖	↗		↘	
Volume (veh/h)	20	315	250	20	50	25
Sign Control		Free	Free		Stop	
Grade		0%	0%		0%	
Peak Hour Factor	0.95	0.95	0.95	0.95	0.95	0.95
Hourly flow rate (vph)	21	332	263	21	53	26
Pedestrians						
Lane Width (ft)						
Walking Speed (ft/s)						
Percent Blockage						
Right turn flare (veh)						
Median type		None	None			
Median storage (veh)						
Upstream signal (ft)						
pX, platoon unblocked						
vC, conflicting volume	284				647	274
vC1, stage 1 conf vol						
vC2, stage 2 conf vol						
vCu, unblocked vol	284				647	274
tC, single (s)	4.2				6.5	6.2
tC, 2 stage (s)						
tF (s)	2.3				3.6	3.3
p0 queue free %	98				87	97
cM capacity (veh/h)	1239				420	770

Direction, Lane #	EB 1	WB 1	SB 1
Volume Total	353	284	79
Volume Left	21	0	53
Volume Right	0	21	26
cSH	1239	1700	495
Volume to Capacity	0.02	0.17	0.16
Queue Length 95th (ft)	1	0	15
Control Delay (s)	0.6	0.0	13.6
Lane LOS	A		B
Approach Delay (s)	0.6	0.0	13.6
Approach LOS			B

Intersection Summary			
Average Delay		1.8	
Intersection Capacity Utilization		47.1%	ICU Level of Service A
Analysis Period (min)		15	

HCM Unsignalized Intersection Capacity Analysis
 24: SE Lynn Blvd & S Combs Flat Rd

2/14/2013



Movement	EBL	EBR	NBL	NBT	SBT	SBR
Lane Configurations						
Volume (veh/h)	90	260	140	110	225	95
Sign Control	Stop			Free	Free	
Grade	0%			0%	0%	
Peak Hour Factor	0.83	0.83	0.83	0.83	0.83	0.83
Hourly flow rate (vph)	108	313	169	133	271	114
Pedestrians				6		
Lane Width (ft)				12.0		
Walking Speed (ft/s)				4.0		
Percent Blockage				1		
Right turn flare (veh)						
Median type				None	None	
Median storage (veh)						
Upstream signal (ft)						
pX, platoon unblocked						
vC, conflicting volume	798	334	386			
vC1, stage 1 conf vol						
vC2, stage 2 conf vol						
vCu, unblocked vol	798	334	386			
tC, single (s)	6.4	6.3	4.1			
tC, 2 stage (s)						
tF (s)	3.5	3.4	2.2			
p0 queue free %	64	55	86			
cM capacity (veh/h)	304	695	1173			
Direction, Lane #	EB 1	NB 1	SB 1			
Volume Total	422	301	386			
Volume Left	108	169	0			
Volume Right	313	0	114			
cSH	522	1173	1700			
Volume to Capacity	0.81	0.14	0.23			
Queue Length 95th (ft)	202	13	0			
Control Delay (s)	34.8	5.4	0.0			
Lane LOS	D	A				
Approach Delay (s)	34.8	5.4	0.0			
Approach LOS	D					
Intersection Summary						
Average Delay			14.7			
Intersection Capacity Utilization			67.1%		ICU Level of Service	C
Analysis Period (min)			15			

HCM Unsignalized Intersection Capacity Analysis

25: US 26 & OR126 (WB)

2/14/2013

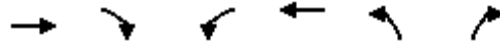

Movement	EBT	EBR	WBL	WBT	NBL	NBR
Lane Configurations				↑	↗	
Volume (veh/h)	0	0	0	810	160	0
Sign Control	Free			Free	Stop	
Grade	0%			0%	0%	
Peak Hour Factor	0.95	0.95	0.95	0.95	0.95	0.95
Hourly flow rate (vph)	0	0	0	853	168	0
Pedestrians						
Lane Width (ft)						
Walking Speed (ft/s)						
Percent Blockage						
Right turn flare (veh)						
Median type	None		TWLTL			
Median storage (veh)	2					
Upstream signal (ft)						
pX, platoon unblocked						
vC, conflicting volume			0	853	0	
vC1, stage 1 conf vol	0					
vC2, stage 2 conf vol	853					
vCu, unblocked vol			0	853	0	
tC, single (s)			4.1	6.5	6.2	
tC, 2 stage (s)	5.5					
tF (s)			2.2	3.6	3.3	
p0 queue free %			100	56	100	
cM capacity (veh/h)			1604	386	1091	

Direction, Lane #	WB 1	NB 1
Volume Total	853	168
Volume Left	0	168
Volume Right	0	0
cSH	1700	386
Volume to Capacity	0.50	0.44
Queue Length 95th (ft)	0	56
Control Delay (s)	0.0	21.3
Lane LOS		C
Approach Delay (s)	0.0	21.3
Approach LOS		C

Intersection Summary			
Average Delay		3.5	
Intersection Capacity Utilization	97.6%	ICU Level of Service	F
Analysis Period (min)		15	

HCM Unsignalized Intersection Capacity Analysis
 26: OR 126 (EB) & US 26 (EB)

2/14/2013



Movement	EBL	EBT	WBT	WBR	SBL	SBR
Lane Configurations		↑			↘	
Volume (veh/h)	0	760	0	0	125	0
Sign Control		Free	Free		Yield	
Grade		0%	0%		0%	
Peak Hour Factor	0.95	0.95	0.95	0.95	0.95	0.95
Hourly flow rate (vph)	0	800	0	0	132	0
Pedestrians						
Lane Width (ft)						
Walking Speed (ft/s)						
Percent Blockage						
Right turn flare (veh)						
Median type		None	None			
Median storage (veh)						
Upstream signal (ft)		475				
pX, platoon unblocked						
vC, conflicting volume	0				800	0
vC1, stage 1 conf vol						
vC2, stage 2 conf vol						
vCu, unblocked vol	0				800	0
tC, single (s)	4.1				6.4	6.2
tC, 2 stage (s)						
tF (s)	2.2				3.5	3.3
p0 queue free %	100				63	100
cM capacity (veh/h)	1636				351	1091

Direction, Lane #	EB 1	SB 1
Volume Total	800	132
Volume Left	0	132
Volume Right	0	0
cSH	1700	351
Volume to Capacity	0.47	0.37
Queue Length 95th (ft)	0	44
Control Delay (s)	0.0	21.3
Lane LOS		C
Approach Delay (s)	0.0	21.3
Approach LOS		C

Intersection Summary			
Average Delay		3.0	
Intersection Capacity Utilization		53.6%	ICU Level of Service A
Analysis Period (min)		15	

HCM Unsignalized Intersection Capacity Analysis
 27: OR 126 & US 26 (EB)

2/14/2013



Movement	EBL	EBT	EBR	WBL	WBT	WBR	NBL	NBT	NBR	SBL	SBT	SBR
Lane Configurations					↑						↑	
Volume (veh/h)	0	0	0	0	675	0	0	0	0	0	125	0
Sign Control		Free			Free			Stop			Stop	
Grade		0%			0%			0%			0%	
Peak Hour Factor	0.95	0.95	0.95	0.95	0.95	0.95	0.95	0.95	0.95	0.95	0.95	0.95
Hourly flow rate (vph)	0	0	0	0	711	0	0	0	0	0	132	0
Pedestrians												
Lane Width (ft)												
Walking Speed (ft/s)												
Percent Blockage												
Right turn flare (veh)												
Median type	None				None							
Median storage (veh)												
Upstream signal (ft)												
pX, platoon unblocked												
vC, conflicting volume	711	0			776			711	0	711	711	711
vC1, stage 1 conf vol												
vC2, stage 2 conf vol												
vCu, unblocked vol	711	0			776			711	0	711	711	711
tC, single (s)	4.1	4.1			7.1			6.5	6.2	7.1	6.5	6.2
tC, 2 stage (s)												
tF (s)	2.2	2.2			3.5			4.0	3.3	3.5	4.0	3.3
p0 queue free %	100	100			100			100	100	100	63	100
cM capacity (veh/h)	898	1636			226			361	1091	351	356	437

Direction, Lane #	WB 1	SB 1
Volume Total	711	132
Volume Left	0	0
Volume Right	0	0
cSH	1700	356
Volume to Capacity	0.42	0.37
Queue Length 95th (ft)	0	43
Control Delay (s)	0.0	20.9
Lane LOS		C
Approach Delay (s)	0.0	20.9
Approach LOS		C

Intersection Summary		
Average Delay		3.3
Intersection Capacity Utilization	48.8%	ICU Level of Service
Analysis Period (min)		15
		A

HCM Unsignalized Intersection Capacity Analysis

28: OR 126 & O'Neil Hwy

2/14/2013



Movement	EBL	EBT	WBT	WBR	SBL	SBR
Lane Configurations						
Volume (veh/h)	20	895	645	140	90	10
Sign Control		Free	Free		Stop	
Grade		0%	0%		0%	
Peak Hour Factor	0.90	0.90	0.90	0.90	0.90	0.90
Hourly flow rate (vph)	22	994	717	156	100	11
Pedestrians						
Lane Width (ft)						
Walking Speed (ft/s)						
Percent Blockage						
Right turn flare (veh)						
Median type		TWLTL	None			
Median storage veh		2				
Upstream signal (ft)			778			
pX, platoon unblocked						
vC, conflicting volume	872				1833	436
vC1, stage 1 conf vol					794	
vC2, stage 2 conf vol					1039	
vCu, unblocked vol	872				1833	436
tC, single (s)	4.2				6.8	7.0
tC, 2 stage (s)					5.8	
tF (s)	2.2				3.5	3.3
p0 queue free %	97				59	98
cM capacity (veh/h)	750				243	563
Direction, Lane #	EB 1	EB 2	WB 1	WB 2	SB 1	
Volume Total	22	994	478	394	111	
Volume Left	22	0	0	0	100	
Volume Right	0	0	0	156	11	
cSH	750	1700	1700	1700	257	
Volume to Capacity	0.03	0.58	0.28	0.23	0.43	
Queue Length 95th (ft)	2	0	0	0	53	
Control Delay (s)	9.9	0.0	0.0	0.0	29.2	
Lane LOS	A				D	
Approach Delay (s)	0.2		0.0		29.2	
Approach LOS					D	
Intersection Summary						
Average Delay			1.7			
Intersection Capacity Utilization			59.4%		ICU Level of Service	B
Analysis Period (min)			15			

HCM Unsignalized Intersection Capacity Analysis

29: Rimrock Rd & OR 126

2/14/2013



Movement	WBL	WBR	NBT	NBR	SBL	SBT
Lane Configurations	↔		↑	↗	↘	↕
Volume (veh/h)	5	35	880	10	50	605
Sign Control	Stop		Free			Free
Grade	0%		0%			0%
Peak Hour Factor	0.90	0.90	0.90	0.90	0.90	0.90
Hourly flow rate (vph)	6	39	978	11	56	672
Pedestrians						
Lane Width (ft)						
Walking Speed (ft/s)						
Percent Blockage						
Right turn flare (veh)						
Median type			None			TWLTL
Median storage (veh)						2
Upstream signal (ft)						1130
pX, platoon unblocked						
vC, conflicting volume	1425	978			989	
vC1, stage 1 conf vol	978					
vC2, stage 2 conf vol	447					
vCu, unblocked vol	1425	978			989	
tC, single (s)	6.8	7.0			4.2	
tC, 2 stage (s)	5.8					
tF (s)	3.5	3.3			2.2	
p0 queue free %	98	84			92	
cM capacity (veh/h)	295	248			683	

Direction, Lane #	WB 1	NB 1	NB 2	SB 1	SB 2	SB 3
Volume Total	44	978	11	56	336	336
Volume Left	6	0	0	56	0	0
Volume Right	39	0	11	0	0	0
cSH	253	1700	1700	683	1700	1700
Volume to Capacity	0.18	0.58	0.01	0.08	0.20	0.20
Queue Length 95th (ft)	16	0	0	7	0	0
Control Delay (s)	22.2	0.0	0.0	10.7	0.0	0.0
Lane LOS	C			B		
Approach Delay (s)	22.2	0.0		0.8		
Approach LOS	C					

Intersection Summary						
Average Delay			0.9			
Intersection Capacity Utilization			60.3%		ICU Level of Service	B
Analysis Period (min)			15			

HCM Unsignalized Intersection Capacity Analysis

30: Tom McCall Rd & OR 126

2/14/2013



Movement	EBL	EBT	EBR	WBL	WBT	WBR	NBL	NBT	NBR	SBL	SBT	SBR	
Lane Configurations		↔			↔			↑	↑		↑	↑	
Volume (veh/h)	125	10	75	25	5	60	30	705	10	30	510	70	
Sign Control		Stop			Stop			Free			Free		
Grade		0%			0%			0%			0%		
Peak Hour Factor	0.90	0.90	0.90	0.90	0.90	0.90	0.90	0.90	0.90	0.90	0.90	0.90	
Hourly flow rate (vph)	139	11	83	28	6	67	33	783	11	33	567	78	
Pedestrians													
Lane Width (ft)													
Walking Speed (ft/s)													
Percent Blockage													
Right turn flare (veh)													
Median type							None						
Median storage (veh)													
Upstream signal (ft)													
pX, platoon unblocked													
vC, conflicting volume	1553	1494	567	1572	1561	783	644					794	
vC1, stage 1 conf vol													
vC2, stage 2 conf vol													
vCu, unblocked vol	1553	1494	567	1572	1561	783	644					794	
tC, single (s)	7.1	6.5	6.2	7.3	6.6	6.3	4.4					4.1	
tC, 2 stage (s)													
tF (s)	3.5	4.0	3.3	3.7	4.1	3.4	2.4					2.2	
p0 queue free %	0	90	84	54	94	83	96					96	
cM capacity (veh/h)	69	113	527	60	100	381	832					827	

Direction, Lane #	EB 1	WB 1	NB 1	NB 2	SB 1	SB 2
Volume Total	233	100	817	11	600	78
Volume Left	139	28	33	0	33	0
Volume Right	83	67	0	11	0	78
cSH	103	145	832	1700	827	1700
Volume to Capacity	2.26	0.69	0.04	0.01	0.04	0.05
Queue Length 95th (ft)	534	102	3	0	3	0
Control Delay (s)	664.8	72.5	1.1	0.0	1.1	0.0
Lane LOS	F	F	A		A	
Approach Delay (s)	664.8	72.5	1.1		1.0	
Approach LOS	F	F				

Intersection Summary		
Average Delay		89.1
Intersection Capacity Utilization	93.1%	ICU Level of Service
Analysis Period (min)		15
		F

HCM Unsignalized Intersection Capacity Analysis

31: Airport Way & OR 126

2/14/2013



Movement	EBL	EBT	EBR	WBL	WBT	WBR	NBL	NBT	NBR	SBL	SBT	SBR
Lane Configurations		↔			↔		↗	↖	↗	↖	↖	↗
Volume (veh/h)	10	5	10	20	5	75	5	660	15	40	565	10
Sign Control		Stop			Stop			Free			Free	
Grade		0%			0%			0%			0%	
Peak Hour Factor	0.92	0.92	0.92	0.92	0.92	0.92	0.92	0.92	0.92	0.92	0.92	0.92
Hourly flow rate (vph)	11	5	11	22	5	82	5	717	16	43	614	11
Pedestrians												
Lane Width (ft)												
Walking Speed (ft/s)												
Percent Blockage												
Right turn flare (veh)												
Median type								None			None	
Median storage (veh)												
Upstream signal (ft)												
pX, platoon unblocked												
vC, conflicting volume	1514	1446	614	1443	1440	717	625			734		
vC1, stage 1 conf vol												
vC2, stage 2 conf vol												
vCu, unblocked vol	1514	1446	614	1443	1440	717	625			734		
tC, single (s)	7.2	6.5	6.3	7.3	6.5	6.4	5.1			4.1		
tC, 2 stage (s)												
tF (s)	3.6	4.0	3.4	3.7	4.0	3.5	3.1			2.2		
p0 queue free %	84	96	98	76	96	80	99			95		
cM capacity (veh/h)	68	123	476	91	123	405	620			880		













Direction, Lane #	EB 1	WB 1	NB 1	NB 2	NB 3	SB 1	SB 2	SB 3
Volume Total	27	109	5	717	16	43	614	11
Volume Left	11	22	5	0	0	43	0	0
Volume Right	11	82	0	0	16	0	0	11
cSH	120	225	620	1700	1700	880	1700	1700
Volume to Capacity	0.23	0.48	0.01	0.42	0.01	0.05	0.36	0.01
Queue Length 95th (ft)	21	63	1	0	0	4	0	0
Control Delay (s)	43.6	35.2	10.9	0.0	0.0	9.3	0.0	0.0
Lane LOS	E	E	B			A		
Approach Delay (s)	43.6	35.2	0.1			0.6		
Approach LOS	E	E						

Intersection Summary

Average Delay		3.5						
Intersection Capacity Utilization		51.5%		ICU Level of Service			A	
Analysis Period (min)		15						

HCM Unsignalized Intersection Capacity Analysis
 40: Peters Rd & Main St

2/14/2013

						
Movement	WBL	WBR	NBT	NBR	SBL	SBT
Lane Configurations						
Sign Control	Stop		Stop			Stop
Volume (vph)	115	10	270	165	5	145
Peak Hour Factor	0.88	0.88	0.88	0.88	0.88	0.88
Hourly flow rate (vph)	131	11	307	188	6	165
Direction, Lane #	WB 1	WB 2	NB 1	NB 2	SB 1	SB 2
Volume Total (vph)	131	11	307	188	6	165
Volume Left (vph)	131	0	0	0	6	0
Volume Right (vph)	0	11	0	188	0	0
Hadj (s)	0.50	-0.70	0.03	-0.58	0.50	0.08
Departure Headway (s)	6.2	5.0	5.0	3.2	5.8	5.3
Degree Utilization, x	0.23	0.02	0.43	0.17	0.01	0.24
Capacity (veh/h)	541	662	698	1121	599	647
Control Delay (s)	9.8	6.9	11.7	6.8	7.6	8.9
Approach Delay (s)	9.6		9.9		8.8	
Approach LOS	A		A		A	
Intersection Summary						
Delay			9.6			
HCM Level of Service			A			
Intersection Capacity Utilization			29.0%		ICU Level of Service	A
Analysis Period (min)			15			

Attachment F
Intersection Performance Summary Table

Intersection Name	Overall Intersection		
	v/c	Delay (sec)	LOS
Lamonta Rd & Harwood St	0.11	11.7	B
Lamonta Rd & NW Deer St	0.08	12.5	B
10th St & Main St	0.54	9.6	A
9th St & Main St	0.37	16.3	C
7th St & Main St	0.57	23.8	C
NE Laughlin Rd & NE Juniper St	0.17	12.5	B
NE Laughlin Rd & S Combs Flat Rd	0.29	13.4	B
4th St & Main St	0.35	16.7	C
NW 9th St & US 26	0.23	13.2	B
US 26 & Harwood Ave	0.69	17.1	B
US 26 & Deer St	0.71	9.8	A
US 26 & Main St	0.95	43.2	D
US 26 & N Elm St	0.59	8.3	A
US 26 & NE Juniper St	0.27	20.2	C
US 26 & NE Knowledge St	0.02	13.4	B
US 26 & S Combs Flat Rd	0.81	30.5	C
US 26 & NE Laughlin Rd	0.07	10.9	B
2nd St & Meadowlakes Dr	0.14	12.2	B
2nd St & Deer St	0.49	16	C
2nd St & Main St	0.75	52.2	F
S 5th St & Main St	0.07	10.7	B
SE Lynn Blvd & Main St	0.65	22.6	C
SE Lynn Blvd & S Fairview St	0.16	13.6	B
SE Lynn Blvd & S Combs Flat Rd	0.81	34.8	D
US 26 & OR 126 (WB)	0.44	21.3	C
OR 126 (EB) & US 26 (EB)	0.37	21.3	C
OR 126 & US 26 (EB)	0.37	20.9	C
OR 126 & O'Neil Hwy	0.43	29.2	D
Rimrock Rd & OR 126	0.18	22.2	C
Tom McCall Rd & OR 126	2.26	664.8	F
Airport Way & OR 126	0.48	35.2	E
Peters Rd & Main St		11.7	A

Section 6
Technical Memorandum 6: Alternatives Analysis





CITY OF PRINEVILLE TRANSPORTATION SYSTEM PLAN



TECHNICAL MEMORANDUM #6: DEVELOPMENT AND ANALYSIS OF ALTERNATIVES

This memorandum presents transportation alternatives for addressing the multimodal transportation system needs that were identified through analysis of existing and future (2035) traffic conditions. These alternatives are compared to the goals, policies, and criteria that were previously developed to help guide the development of the City's Transportation System Plan.

The improvement alternatives presented herein are not intended to be an all-inclusive list, but represent the range of suggestions identified by the City, stakeholders, and general public. Objective comparisons of the alternatives identifies trade-offs between various concepts that will inform the development of the City's 20-year multi-modal Transportation System Plan.

Alternatives are evaluated independently, by mode, to allow for comparison of projects. The recommendations in this memorandum will be provided to the Technical Advisory Committee (TAC) and Project Advisory Committee (PAC) members for input and guidance on a final project set.

TRANSPORTATION NEEDS

Technical Memorandum #5 identified multimodal transportation system needs related to safety, operations, and connectivity through the year 2035. These needs, and subsequent comments and input from the advisory teams, are addressed within this memorandum. This document addresses system-wide issues, corridor needs, pathway, trail, and sidewalk needs, and individual intersection improvements.

RECOMMENDED ROADWAY FUNCTIONAL CLASSIFICATION

The City's Roadway Functional Classification system identifies where collector and arterial roadways will be located and how they will be connected to serve growth within the Prineville urban growth boundary. The purpose of this classification system is as follows:

- Identify City connectivity and general alignment needs to serve urban development.
- Inform right-of-way preservation and roadway construction needs as part of property development or redevelopment.
- Provide guidance on priorities.
- Identify a process for exceptions or deviations from the standards based on area-specific context or other considerations.

Figure 6-1 illustrates the recommended roadway functional classification system within Prineville. This recommended functional classification system categorizes the City's primary

roadways as *Major* and *Minor Arterials* and *Major* and *Minor Collectors*. All other roadways are classified as *Local Streets*.

Generally, priority issues this classification scheme addresses are:

- Continued identification of a northern extension of Combs Flat Road to connect through the Iron Horse property to Peters Road. This connection forms a parallel route to Main Street for east Prineville, and connects north Prineville with shopping and recreation routes.
- Relocation of the O'Neil Highway connection to OR 126. A specific location for the highway is not identified, and would need to be further reviewed in the current land use and infrastructure context.
- An extension of Peters Road from its intersection with Main Street west to Lamonta Road, connecting near Lon Smith Road or Gardner Road. This roadway would serve adjacent industrial lands and provide a collector roadway function to reduce traffic on Main Street.
- Alignment of Tom McCall and Millican Road within the City's industrial lands. The consolidation of these intersections would allow intersection improvements at OR 126 to benefit connectivity to the north and south sides of the highway.
- Extension of S 2nd Street east to connect to Combs Flat Road. This connection will provide a parallel route to Lynn Boulevard and 3rd Street, improving the grid network in the southern portion of the City.
- Extension of S 5th Street east to connect to SE Willowdale Drive/Ochoco Logging Road. This connection will provide a parallel route to Lynn Boulevard and 3rd Street, improving the grid network in the southern portion of the City.
- Connect the missing segment of Elm Street between S 5th Street and S 6th Street. This will improve north-south connectivity between downtown Prineville and the schools.
- Classifications were modified to follow standard naming conventions. These naming conventions clarify the distinction between local streets and higher-order roadways.

The need to construct, extend, or improve specific corridors may only occur with development, or could be provided as land sales occur to minimize impact to existing owners. The overall functional classification system is intended to serve as a blueprint that provides an orderly plan for growth, so that with development of the UGB right-of-way and connectivity will be preserved, regardless of where that development occurs.

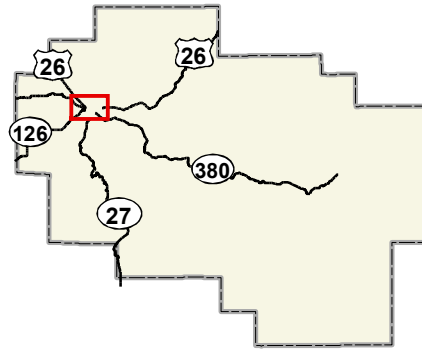

Functional Roadway Classifications

Major Arterial

Minor Arterial

Existing

Future

Major Collector

Existing

Future

Vision

Minor Collector

Existing

Future

Vision

City Boundary

Study Area/Urban Growth Boundary (UGB)

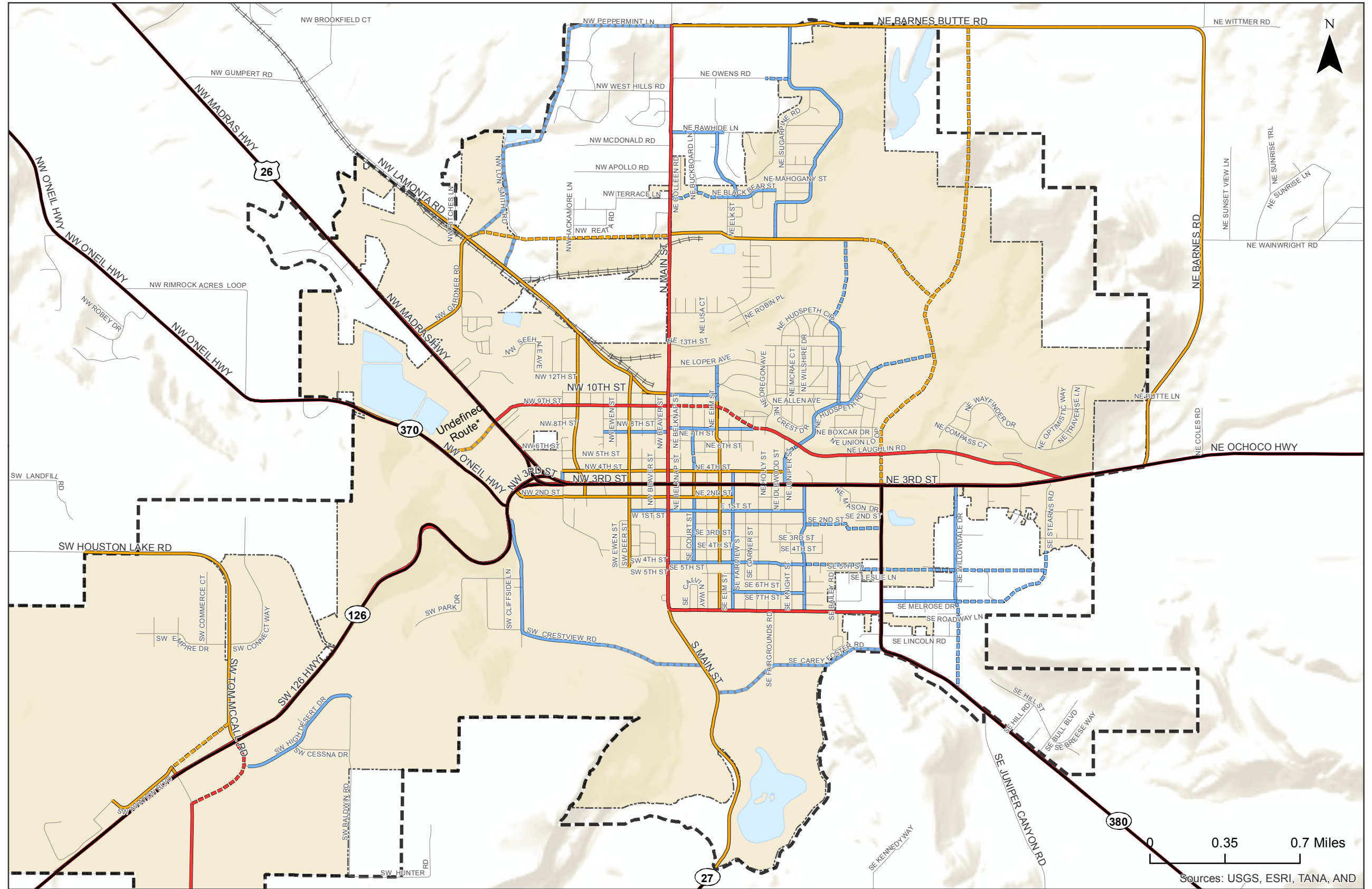

* OR 370 should be rerouted to connect with US 26, but is not needed within the 20-year planning horizon. Route is yet to be determined.

Proposed Functional Classification City of Prineville, Oregon

Figure 6-1

H:\projects\12221 - Prineville TSP\figs\Memo6-1 Proposed Functional Classification.mxd - cbergh - 4:45 PM 5/6/2013



Local Street Policies

In addition to the functional classification for major roadways, it is also recommended that the City adopt local roadway policies to support and preserve major roadways. These policies should accomplish the following:

- Enable direct trips to and from nearby compatible uses with shorter block lengths; this can be provided with pathways, roadways, or other types of connections designed primarily for non-motorized users.
- Ensure local streets are interconnected to form a grid network, providing redundancy and reducing reliance on higher-order roadways.
- Driveway policies to promote access from the lowest-order (or lowest volume where classifications are the same) roadway adjacent to a parcel.
- Discourage cul-de-sacs while providing other options for traffic calming.

While the Transportation System Plan generally focuses only on the higher-order collector and arterial roadway network, the following local street connections were identified as needed improvements as they can help offload the major roadway system both from a safety and capacity perspective.

- Extend SE 4th Street to connect into a southerly extension of Idlewood Street. Similar to extension of SE 5th Street, this connection will complete missing grid connections.
- Realign the 10th Street connection with Lamonta Road as a perpendicular "T" intersection.

Roadway Cross-Sections

Roadway cross-sections, together with access spacing standards, identify the function of a road and its balance between mobility and accessibility. Establishment of these standardized sections are intended to provide consistent performance along a roadway for a given mode, and to help establish consistent guidance and an understanding of costs as new development occurs. However, the sections presented are not intended to be a rigid standard, but to allow flexibility for a roadway to fit within its surrounding context, whether that context is a location within an industrial complex, in a new or built-out neighborhood, along a sensitive environmental area, or adjacent to a school. The standards are also intended to convey the priority or service provided to a given travel mode.

The critical elements that comprise the roadway cross-sections are listed below, along with their intended function.

- Median: The median can serve a variety of purposes and take a variety of forms. Raised medians for access control may only be appropriate on the highest order City or State facilities where throughput is a priority. Painted medians may be appropriate for designated turn lanes or continuous two-way left-turn lanes. Medians may also be used to provide landscaping, water/snow storage or treatment, or pedestrian refuge areas. There are a variety of functions a median can provide. There are safety aspects as they can be used to reduce conflict points, physically separate opposing motorists, remove stopping or

decelerating vehicles from the higher-speed through lanes, allow pedestrians improved opportunities to cross a roadway. The design and dimensions of medians can vary significantly depending on the desired landscape/hardscape treatment, intended purpose, and type of facility.

- **Travel lanes:** Travel lanes purpose is to convey automobile and freight traffic, and in lower speed environments serve as a shared area for bicyclists. Travel lanes should provide a minimum width of 11 feet and a maximum width of 14 feet along straight roadway sections, and may require a larger minimum width along curves. The travel lane width should consider the posted speed, type of user (trucks, cars, bicyclists), location and design of storm grates, adjacent vegetation, and presence of on-street parking to allow these widths to serve as a clear and unimpeded travel way.
- **Bicycle lanes:** Bicycle lanes provide a separate designated travel lane for bicyclists to travel in, allowing them to operate independently from auto traffic. Bicycle lanes also serve a buffering purpose for pedestrians by designating the limits of a travel lane to motorists. Design guidance of bicycle lanes (to include minimum effective widths, height, grades, and obstructions) should be based on information contained in the current edition of the Oregon Pedestrian and Bicycle Design Guide.
- **Curb:** Curbing provides a physical barrier between parked or moving cars, bicyclists, and pedestrians. It also serves a function in channelizing storm runoff.
- **Planter Strip/Swale:** Planter strips can serve several purposes from containing above or underground utilities, luminaires, and signs, providing runoff pre-treatment or storage, beautification, shade/comfort to pedestrians, and buffering between vehicles and pedestrians.
- **Sidewalks:** Dimensions for sidewalks should follow the Oregon Pedestrian and Bicycle Design Guide, and consider both horizontal and vertical clearance. Of particular importance along sidewalks is the clear space around poles, utilities, and other obstructions. The design of sidewalks should also consider the needs of users in wheelchairs or pushing strollers, accounting for slopes and vertical displacement.
- **Right-of-way:** The right-of-way contains all of the elements described above for public use, and typically provides additional space either for future improvements or utilities.

Existing City of Prineville roadway cross-sections and recommended changes are summarized below.

Minor Arterial

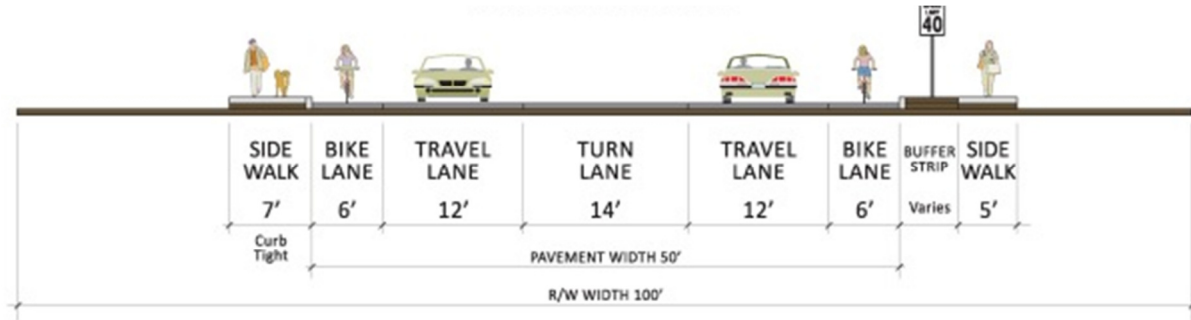

Recommended changes:

- Provide a minimum detached sidewalk width of 6 feet.
- Remove landscape strips, but allow as an option. If provided ensure adequate width is available for landscaping.
- Ensure City design specifications require flush storm grates compatible with bicyclists.
- Ensure City design specifications provide adequate clearance around signs, utilities, and other obstructions on curb-tight sidewalks.
- Travel lanes along freight routes should include 14-foot travel lanes.

Major Collector

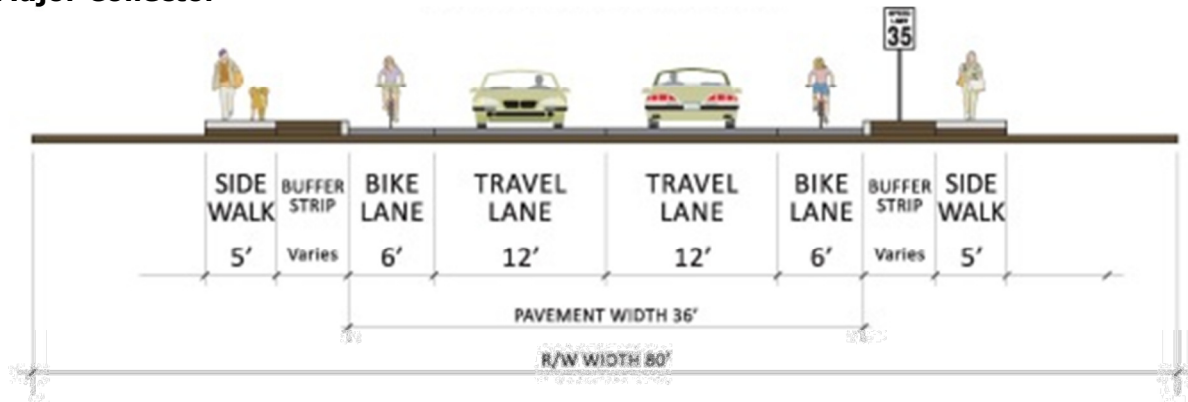

Recommended changes:

- Provide a minimum detached sidewalk width of 6 feet.
- Remove landscape strips, but allow as an option. If provided ensure adequate width is available for landscaping.
- Ensure City design specifications require flush storm grates compatible with bicyclists.
- Ensure City design specifications provide adequate clearance around signs, utilities, and other obstructions on curb-tight sidewalks.
- Include widening for turn lanes (with a minimum width of 12 feet) at major intersections with other collector and arterial facilities.
- Freight routes on major collectors should include 14-foot travel lanes.

Minor Collector

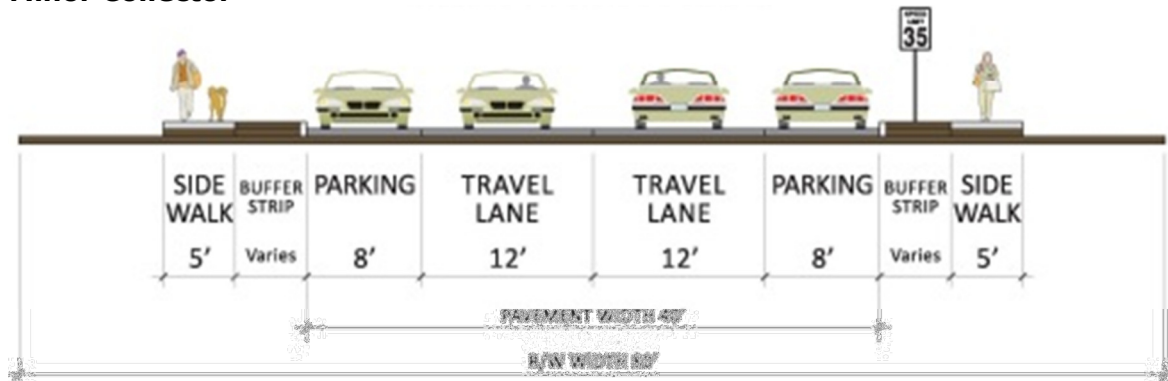

Recommended changes:

- Provide a minimum detached sidewalk width of 6 feet, and ensure City design specifications provide adequate clearance around signs, utilities, and other obstructions on curb-tight sidewalks.
- Consider curb bulb-outs at intersection corners to define parking areas, improve pedestrian visibility, and reduce roadway crossing widths.
- Remove landscape strips, but allow as an option. If provided ensure adequate width is available for landscaping.
- Include widening for turn lanes (with a minimum width of 12 feet) at major intersections with other collector and arterial facilities as deemed appropriate.

Industrial Collector

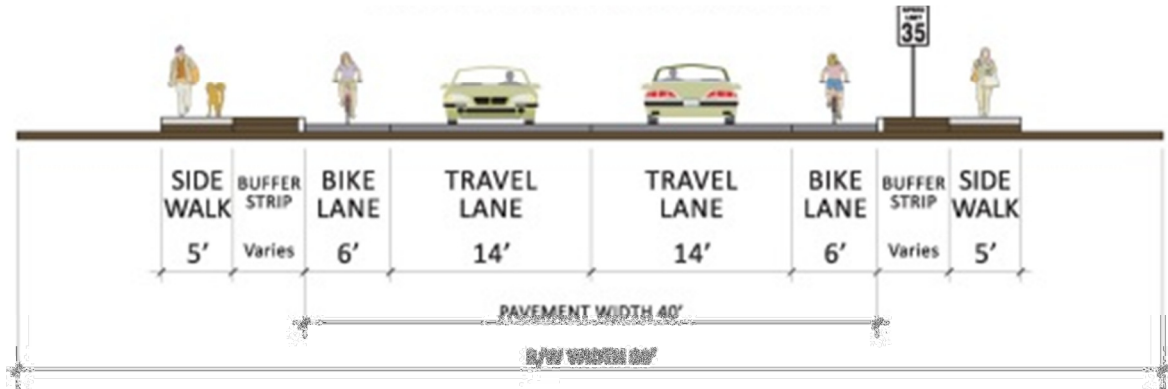

Recommended changes:

- It is recommended that this cross-section be removed and provisions for wider lanes be included in the Collector classifications for roadways serving industrial lands or freight uses.

Industrial



Recommended changes:

- It is recommended that this cross-section be removed and provisions for wider lanes be included in the Collector classifications for roadways serving industrial lands or freight uses.
- Allowance of on-street parking in lieu of designated bicycle lanes within the collector standard should include review of travel speeds to ensure that shared use of the travel lanes is appropriate.

Local Residential

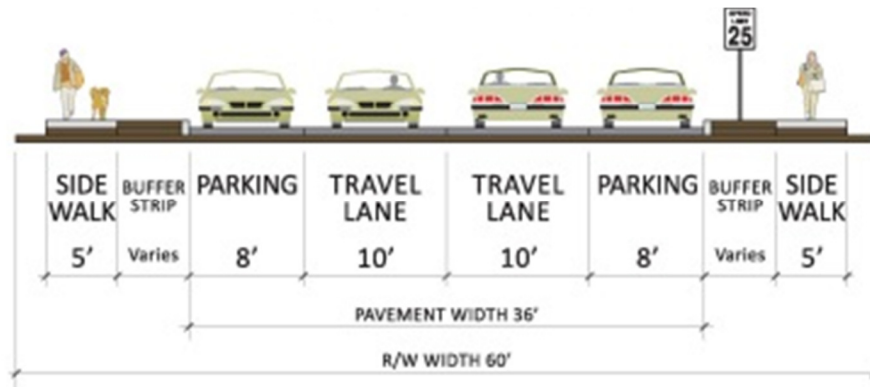

Recommended changes:

- Provide a minimum detached sidewalk width of 6 feet, and ensure City design specifications provide adequate clearance around signs, utilities, and other obstructions on curb-tight sidewalks.
- Remove landscape strips, but allow as an option. If provided ensure adequate width is available for landscaping.
- Require illumination at intersections.
- Increase travel lane widths along sharp roadway bends.
- Restrict rolled-curbs in residential areas.
- Consider curb bulb-outs at intersection corners to define parking areas, improve pedestrian visibility, and reduce roadway crossing widths.

Deviation Process

A deviation request process is recommended that will allow the City to provide guidance while still allowing flexibility. This system is intended to adapt to the surrounding context, and allow the City to consider deviations based on adjacent land use, topographical, environmental (natural and man-made), historical, or other contextual opportunities and constraints. A deviation process should include flexibility within the standards while addressing the intent. Deviations should not be allowed for self-imposed hardships, but to provide alternative ways to meet the functional purpose. The deviation process should specifically address the original standard, the proposed change, and how the functional intent will continue to be met or why it would be unreasonable to do so. The deviation applied to a cross-section should include the longitudinal considerations, such as how pedestrian crossings would be provided if, for example, an eight-foot wide buffered trail system were proposed on one side of the roadway.

ALTERNATIVES DEVELOPMENT

Several alternatives are evaluated to address the transportation system needs as identified in Technical Memorandum #5. The highest levels of congestion within the City occur along the 3rd Street corridor. In order to address this key issue, the primary alternatives focus methods of

alleviating the congestion on 3rd Street. In addition, other corridor and intersection improvements will be suggested to address specific needs identified for the City.

A range of transportation improvements were identified and presented to the advisory committees on February 19, 2013. Based on their feedback, some alternatives were revised and additional options were developed. Advisory committee comments are provided along with the meeting handouts in Appendix D.

The key improvement options identified through discussions with the advisory committees include:

- Developing alternative local routes within the City to alleviate congestion;
- Constructing a new southerly “Brummer Road” alignment to more directly connect Juniper Canyon to OR 126;
- Widening 3rd Street to provide a five-lane facility through the City; and,
- Creating a couplet with 3rd Street and either 2nd or 4th Street.

Travel demand models prepared by ODOT’s Transportation Planning and Analysis Unit (TPAU) were used to assess the change that would occur with each of these strategies. The no-build model output was post processed using existing counts at study intersections. Model output for future scenarios showing potential alternative routes was used to determine how each route would influence the surrounding transportation network.

CORRIDOR ALTERNATIVES

This section summarizes the alternatives developed along critical City of Prineville corridors to meet needs identified within Technical Memorandum #5.

3rd Street Corridor Alternatives

The 3rd Street corridor serves as the main east-west connection for intercity and regional travel. As such, the alternatives and improvements identified for 3rd Street influence travel patterns throughout the northern, eastern, and southern areas of the city. Therefore, alternatives for 3rd Street were identified and evaluated first.

Three alternatives were identified to address the capacity and delay constraints on 3rd Street. The alternatives include parallel routes, corridor widening, and/or conversion to a couplet system.

Alternative 1: Parallel Routes

To alleviate congestion on 3rd Street this alternative proposes constructing and connecting parallel east-west and north-south routes to provide alternative options for traffic traveling through town. Parallel routes were evaluated to develop an understanding of their cost relative to the effectiveness of each route in alleviating congestion on 3rd Street. As identified through the TAC and PAC feedback, parallel routes include the NE 9th Street extension, Combs Flat Road extension and connection with Peters Road, Peters Road extension to Lamonta Street, and the Crestview

Road connection to Main Street. Figure 6-2 shows the approximate locations of the evaluated parallel routes.

The approach to evaluating the parallel route options was as follows:

1. Estimate the amount of traffic from 3rd Street that would divert to the parallel routes, if constructed.
2. Consider whether parallel routes are a feasible alternative based on cost, right-of-way, and other impacts.
3. If parallel routes are feasible alternatives, evaluate forecast traffic operations based on volume scenarios established in Step 1.
4. If parallel routes alleviate congestion on 3rd Street, estimate the impacts by reviewing intersection operations along 3rd Street and key intersections of parallel routes.
5. Calculate an estimated benefit and planning level estimate of cost associated with each parallel route. The benefit was estimated by determining the number of trips diverted from 3rd Street, and the cost was estimated based on the length of the proposed route.

Crestview Road Connection to Main Street



Feedback concerning the Crestview Road connection at the February meeting varied among respondents. Although it was noted that a secondary access would be beneficial, others felt the benefit the connection will have does not warrant the high cost of the project. The travel demand model showing this potential future connection revealed the number of trips that are expected to utilize the proposed connection during the PM peak hour in the year 2035. Based on this model, only 29 eastbound trips and 29 westbound trips are predicted for the connection during the peak hour. While the facility would serve a limited public benefit (primarily as an alternative access to the Rimrock neighborhood), the development of adjoining properties, such as the River Steppes development, would significantly increase dependence on this route. Accordingly, it is recommended that this route be retained in the City's Transportation System Plan, but the construction of this connection would be driven by development and not tied to relief of 3rd Street congestion.

Brummer Road

The potential Brummer Road connection would provide connectivity between Juniper Canyon and Millican Road, as shown in Figure 6-2. Comments received from the advisory committees noted the emergency access benefits, but identified concern that the cost to construct the Brummer Road connection would be too high relative to the benefit derived, particularly given the Crooked River and Rimrock crossings.

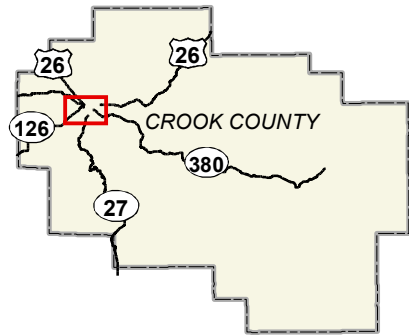
As this connection would be located outside of City limits, the Crook County plans were reviewed to identify potential alignments for this route. While no alignment was identified in the County plans between Main Street and Millican Road, the Davis Road alignment showed a potential connection to the Juniper Canyon area. This information was provided to ODOT TPAU, along with a potential extension of this route further west to Millican Road. The model results showed that due to the travel speed and indirectness of this route its use would be very limited,



-  Parallel Segments
-  City Boundary
-  Study Area/Urban Growth Boundary (UGB)

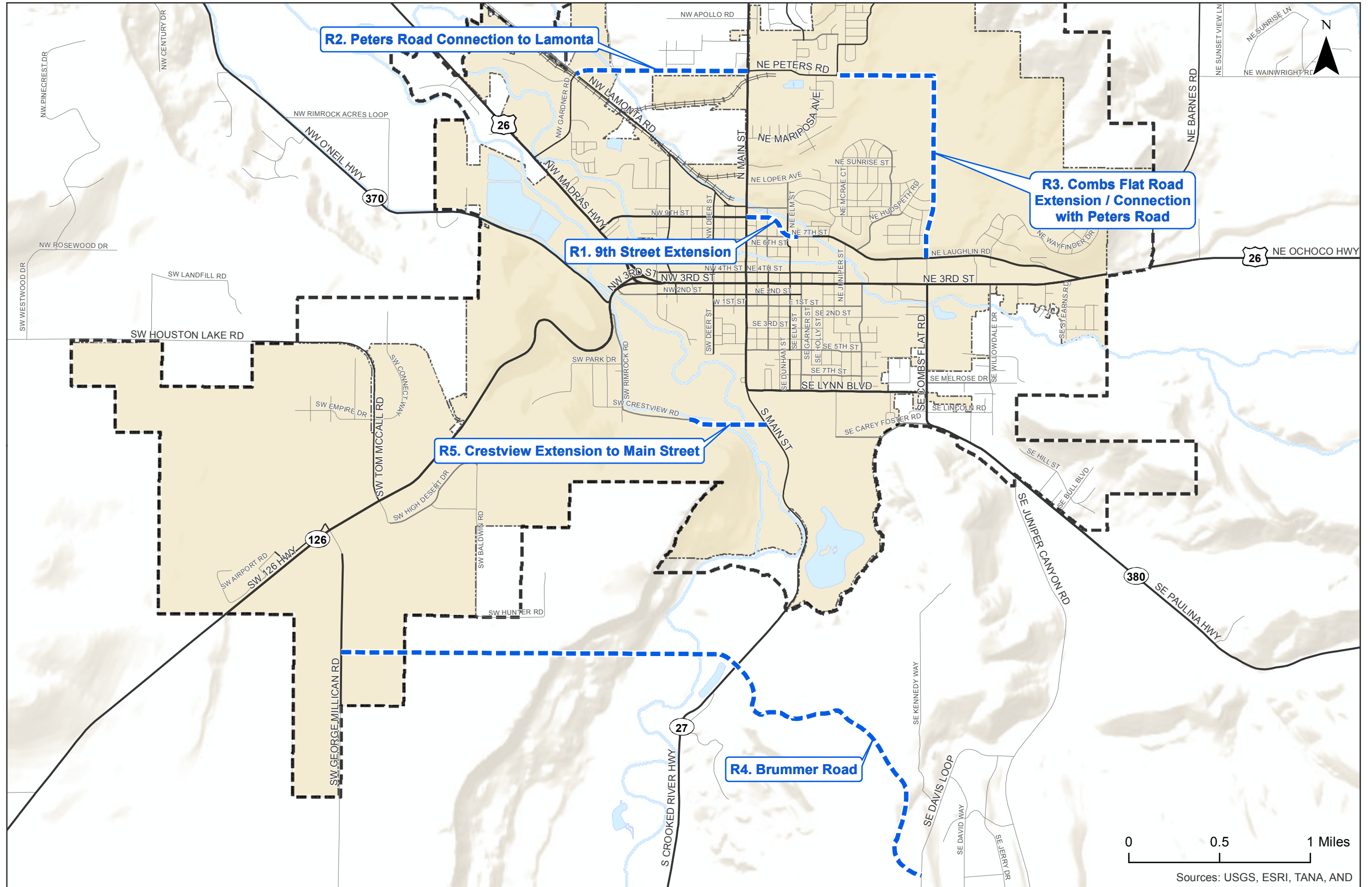

Sources: USGS, ESRI, TANA, AND

**Parallel Routes
City of Prineville, Oregon**

**Figure
6-2**

H:\proj\12221 - Prineville TSP\gis\Memo 616-1 Parallel Routes.mxd - bommerville - 12:10 PM 5/3/2013

providing a very low cost/benefit ratio. Accordingly, while the connection has merit for emergency access, it is recommended that for typical commute purposes this alternative does not adequately serve the City of Prineville needs. Benefits of this connection would primarily be limited to areas outside of City limits, and should therefore be considered only as part of future County transportation plans.

Peters Road Connection to Lamonta Road

The proposed Peters Road connection would link Peters Road west past Main Street to intersect with Lamonta Road at its intersection with Gardner Road, as shown in Figure 6-2. This connection would provide a direct route between US 26 and Main Street as part of a northern arterial. The advisory committee was favorable of this alignment as it helps to address both the Main Street and 3rd Street congestion and provides an alternate route for northern Prineville residents.

Travel demand models showed that this connection would be expected to carry about 150 trips in each direction during the 2035 weekday commute hour, alleviating some congestion throughout the City's network and improving access to industrially-zoned properties. As this project would directly address critical City needs, improve connectivity, provide redundancy, and have economic benefits it is recommended that this connection be carried forward.

9th Street Extension

The proposed 9th Street Extension, shown in Figure 6-2, completes the continuous connection along US 26 from west of the "Y" to east of Combs Flat Road. The western section of this connection has been completed, and NE 7th Street and Laughlin Road currently provide the eastern connection. Completion of the 9th Street extension would eliminate the disconnect along Main Street and reroute this traffic further from adjoining residential areas.

Completing the eastern portion of the 9th Street extension would largely reroute traffic currently on NE 7th Street, but would provide a better grid network and avoid the jog in this route that occurs along Main Street. This alignment would be better suited to the surrounding context and better serve as an alternative to 3rd Street.

Combs Flat Road Extension

Combs Flat Road currently terminates at Laughlin, with access to the Iron Horse property obtained from Hudspeth. An extension of Combs Flat Road (as a City facility) would more directly provide access between Iron Horse and the commercial services near 3rd Street, and form an eastern parallel route to Main Street. While the specific alignment will need to be coordinated with topographic and infrastructure needs, the alignment of this connection would extend north to connect with Peters Road, as shown in Figure 6-2. Comments received from the advisory committee indicate that this is a high priority route given the expected development on the east side of the City, and would complete a northern arterial route around the City. It is recommended that this route be included as part of a parallel routes alternative.

Preferred Parallel Routes Analysis

Based on the feedback received from the TAC and PAC and the TPAU 2035 model output, three primary connections were selected to further assess how parallel routes could relieve the congestion along 3rd Street: the 9th Street Extension, Combs Flat Road Extension, and the Peters Road Connection.

Based on the estimated traffic that would utilize alternative routes along these connections, the performance of each study intersection was reviewed and compared to the adopted performance standards, as shown in Figure 6-3. This analysis shows that completion of these parallel routes can provide adequate mitigation throughout the 3rd Street corridor to meet the horizon year 2035 mobility targets. *Appendix E contains technical worksheets and materials for this alternative.*

Alternative 2: 3rd Street Widening

Widening N 3rd Street to five-lanes provides an additional travel lane in both directions and increases vehicular capacity along 3rd Street. A conceptual illustration of a 5-lane cross-section over the existing N 3rd Street cross-section is shown in Figure 6-4. The additional travel lanes would provide additional throughput and reduce congestion, as indicated by the operational analysis results shown in Figure 6-5.

The widening associated with this alternative would eliminate all on-street parking, reduce existing sidewalks, impact driveways, and impact business frontage. The impacts to local businesses on the 3rd Street corridor have not been quantified, although any impact to local businesses in Prineville is expected to be significant.

Despite any operational benefits derived, due to the impacts to the City's downtown, costs to reconstruct 3rd Street and the transition points, and conflicts with the Special Transportation Area designation along 3rd Street, it is recommended that this alternative not be further considered.

Alternative 3: Couplet Options

A couplet is a pairing of two one-way roads to provide two-way travel. A couplet option for Prineville could include use of 2nd Street, 4th Street, and 3rd Street in some combination. The benefit of a couplet is that it simplifies and improves signal timing, improves management of travel speeds, and provides breaks in traffic for side-street approaches. A couplet will increase capacity as it provides two lanes of travel in each direction through downtown Prineville.

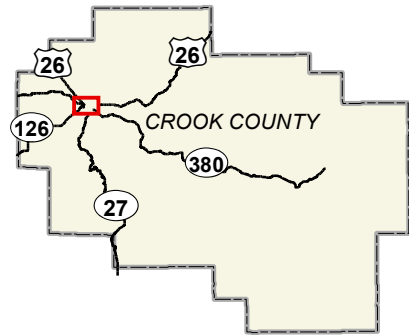

- Study Intersection Level-of-Service**
- "C" or Better
 - "D" or "E"
 - "F"
 - City Boundary
 - Study Area/Urban Growth Boundary (UGB)

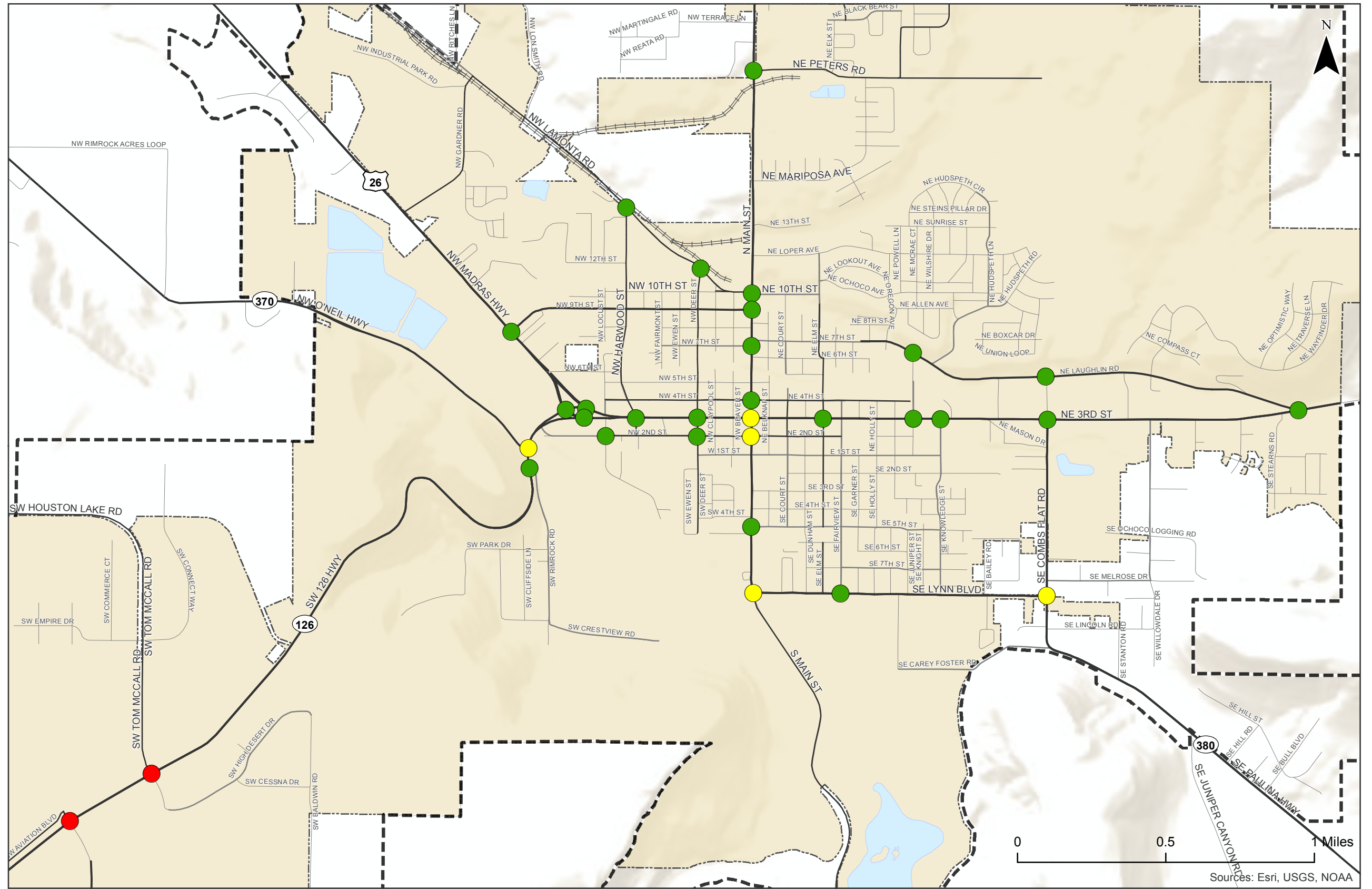

Sources: Esri, USGS, NOAA

**Parallel Route Alternative - Study Intersections Operations
City of Prineville, Oregon**

**Figure
6-3**

K:\H_Portland\proj\12221 - Prineville TSP\GIS\Memo 616-2 Parallel Route Alternative - Study Intersections Operations.mxd - agriffin - 6:44 PM 5/3/2013

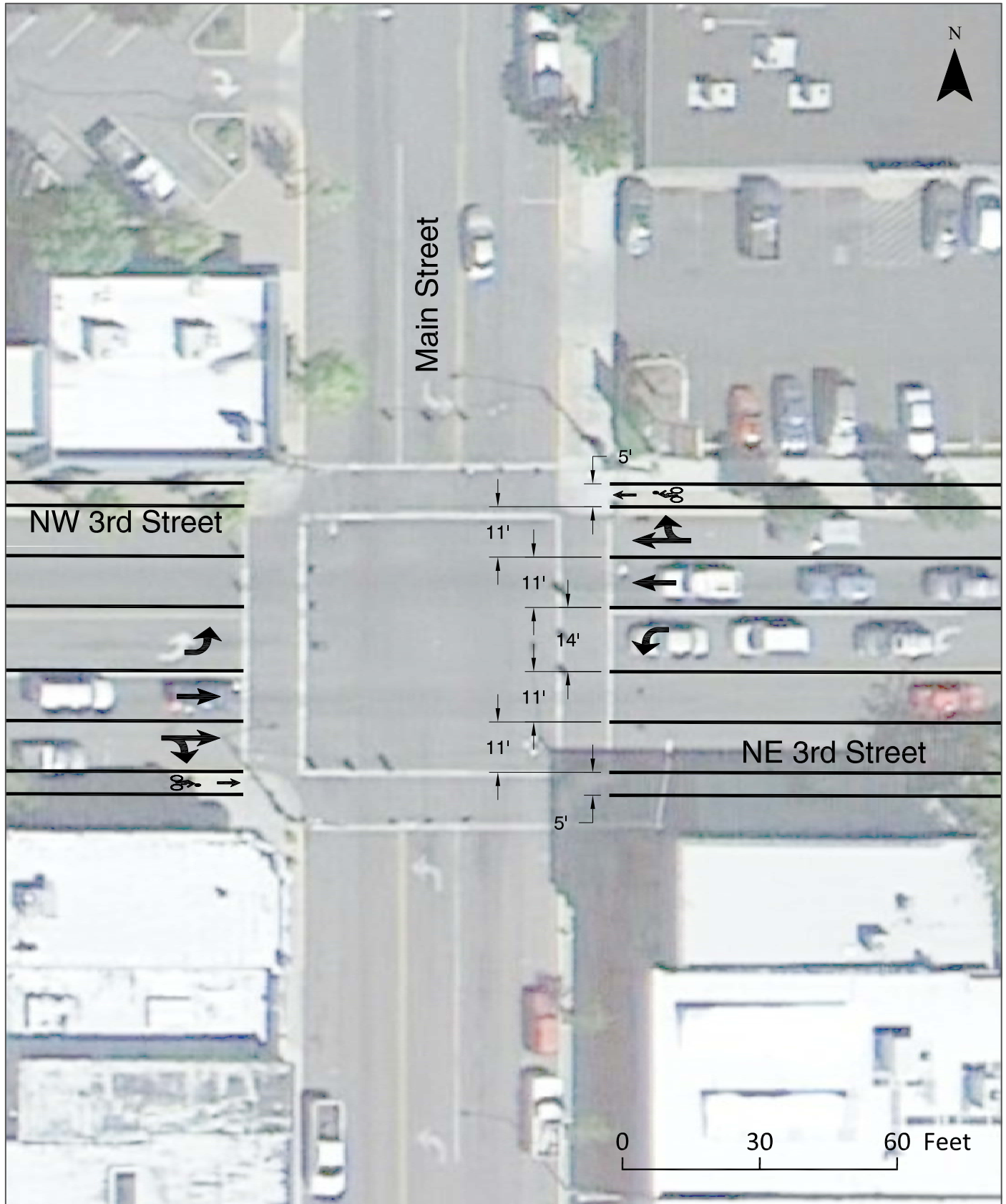

**Street Widening Impacts
City of Prineville, Oregon**

**Figure
6-4**

H:\proj\file12221 - Prineville TSP\dwg\figs\Memo6\Memo6_Fig01.dwg May 03, 2013 - 1:38pm - jsommerville Layout Tab: 6-3

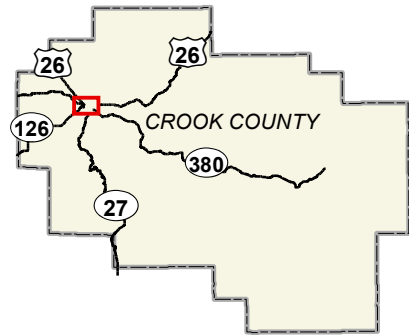

Study Intersection Level-of-Service

- "C" or Better
- "D" or "E"
- "F"

- City Boundary
- Study Area/Urban Growth Boundary (UGB)

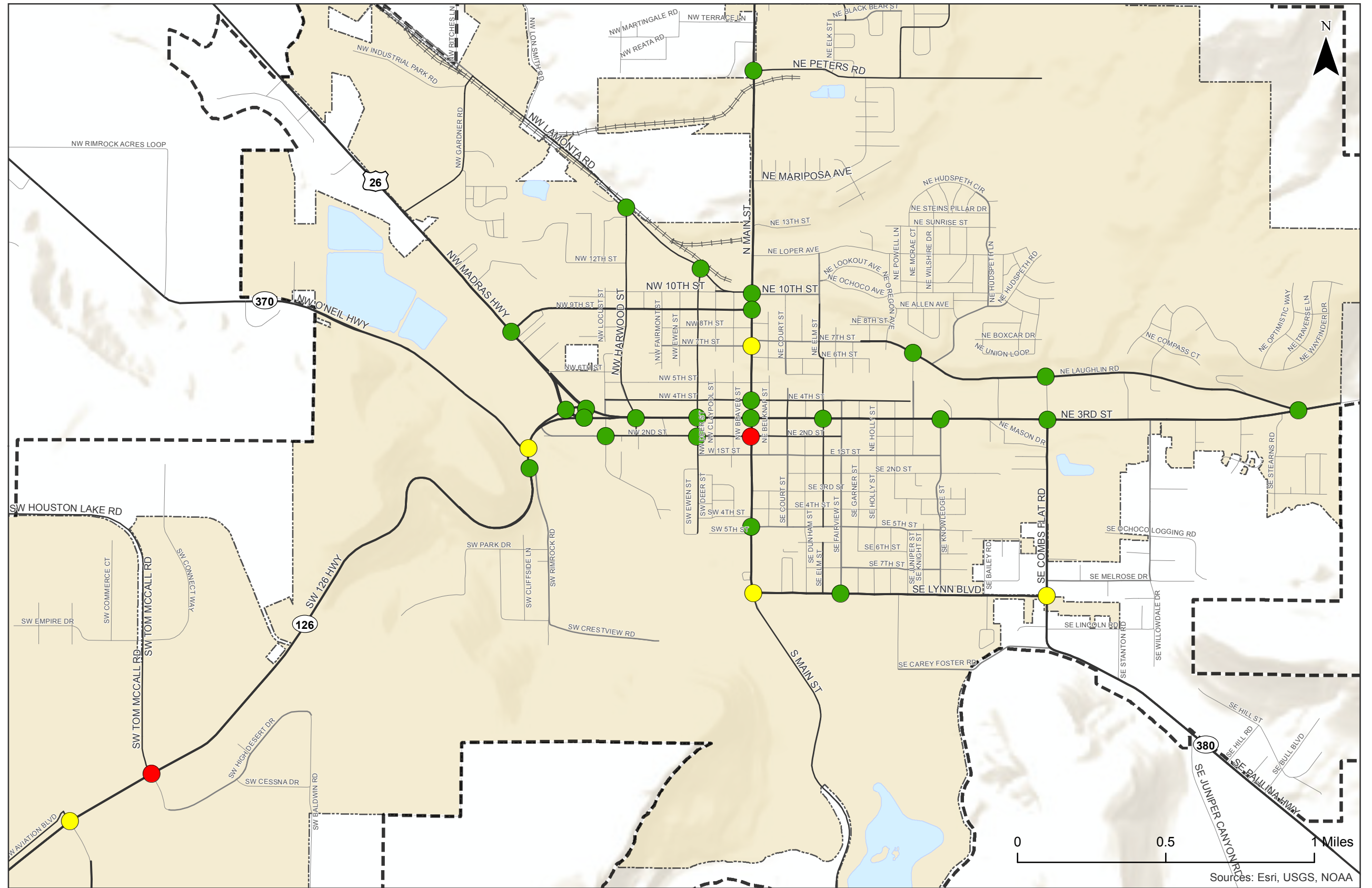

**Widened 3rd Street Alternative - Study Intersections Operations
City of Prineville, Oregon**

**Figure
6-5**

K:\H_Perland\proj\12221 - Prineville TSP\GIS\Memo 616-5-Widened 3rd Street Alternative - Study Intersections Operations.mxd - agriffin - 6:03 PM 5/3/2013

For this analysis, two couplet alternatives were considered:

- A 2nd Street/3rd Street couplet, as shown in Figure 6-6, and
- A 3rd Street/4th Street couplet, as shown in Figure 6-7.

A 2nd Street and 4th Street couplet system was not considered as it would require the reconstruction of two roadways, it would increase the impacted areas, and would further impact the businesses along 3rd Street.

This alternative would be costly, as it would require fully reconstructing either 2nd Street or 4th Street to accommodate the weight and volume of highway traffic. It would also require reconstruction of traffic signals, a transition area to bring the roadways to and from one-way operations, and would have land use impacts.

The advisory committee identified significant concerns related to using either 4th Street or 2nd Street as a couplet. By using the northern route (4th Street), there would be significant impacts to the Ochoco Creek Park, and less economic opportunities to expand the downtown. Alternatively, use of 2nd Street would conflict with the existing neighborhoods and zoning, but could provide increased redevelopment opportunities. Concerns were also raised regarding any couplet, and the impacts it could bring to the businesses located along 3rd Street.



Operationally, either alignment could provide acceptable traffic operations. Operations for the 2nd and 3rd Street couplet alternative are shown in Figure 6-8.

3rd Street Corridor Alternative Evaluation

In order to compare the 3rd Street Alternatives, five criteria were selected to qualitatively evaluate the alternatives. Each alternative was given a star rating of high (full star), medium (half star), or low (no star) based on relative performance of each alternative for each category summarized below. The more stars, the better the alternative is expected to perform relative to other alternatives.

- Construction Cost: The construction cost of each alternative was estimated based on proposed length, cross-section, and location. The construction cost estimate does not include additional costs such as design, steep grades, and right-of-way acquisition. Each alternative was given either a high, low, or medium cost as follows:
 - Low Cost (full star): Indicates the estimated construction cost for the alternative is less than \$5 million.
 - Medium Cost (half star): Indicates the estimated construction cost for the alternative is between \$5 million and \$10 million.
 - High Cost (empty star): Indicates the estimated construction cost for the alternative exceeds \$10 million.



-  Couplet
-  City Boundary
-  Study Area/Urban Growth Boundary (UGB)

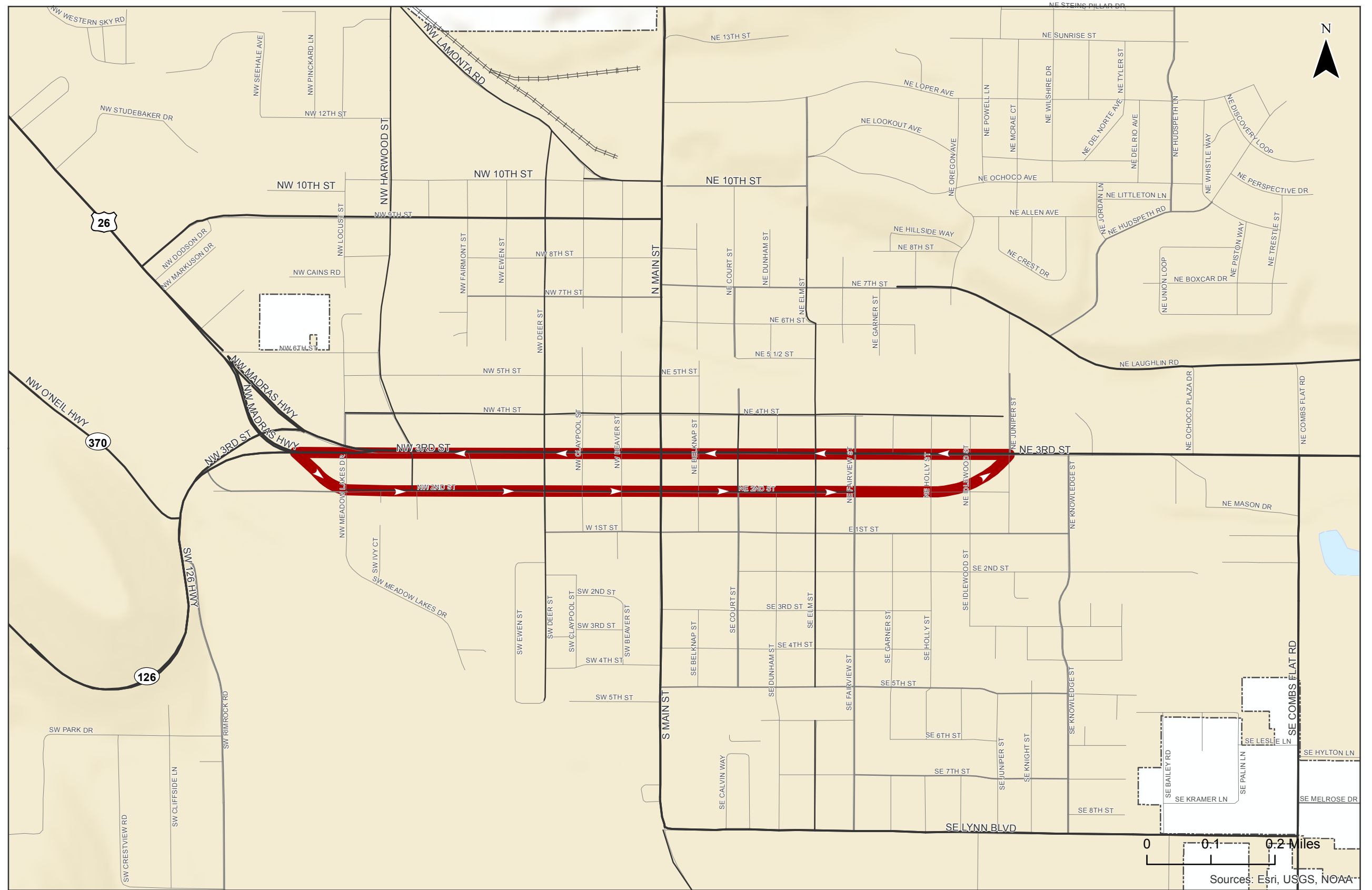



**2nd and 3rd Street Couplet
City of Prineville, Oregon**

**Figure
6-6**

K:\H_Perland\proj\12221 - Prineville TSP\gis\Memo 616-4-2nd & 3rd Street Couplet.mxd - agiffin - 5:31 PM 5/3/2013



-  Couplet
-  City Boundary
-  Study Area/Urban Growth Boundary (UGB)

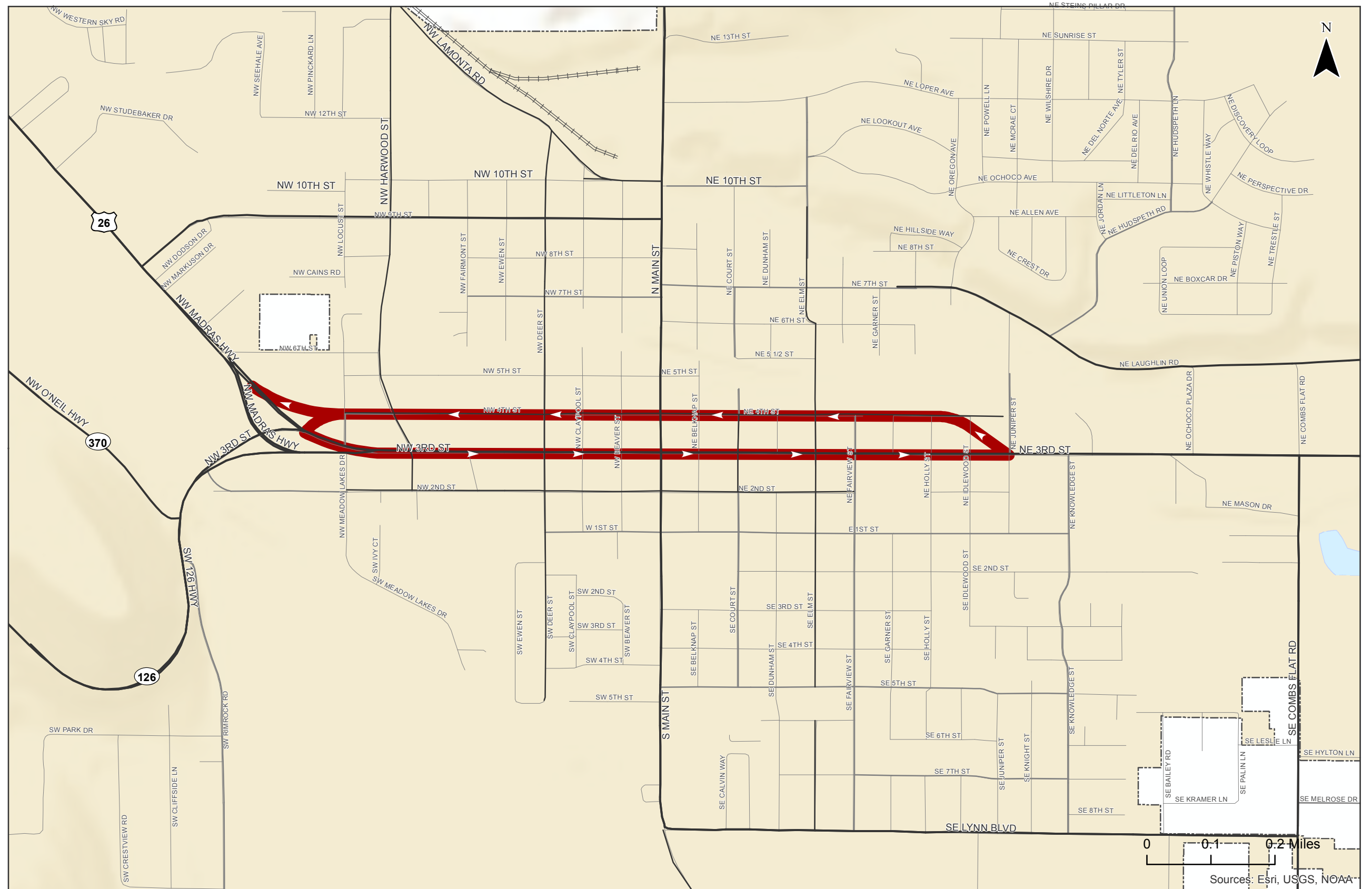

3rd & 4th Street Couplet
City of Prineville, Oregon

Figure
6-7

K:\H_Perland\proj\12221 - Prineville TSP\gis\Memo 616-5-3rd & 4th Street Couplet.mxd - agiffin - 5:44 PM 5/3/2013

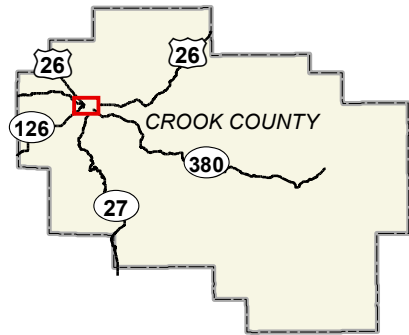

- Study Intersection Level-of-Service**
- "C" or Better
 - "D" or "E"
 - "F"
 - City Boundary
 - Study Area/Urban Growth Boundary (UGB)

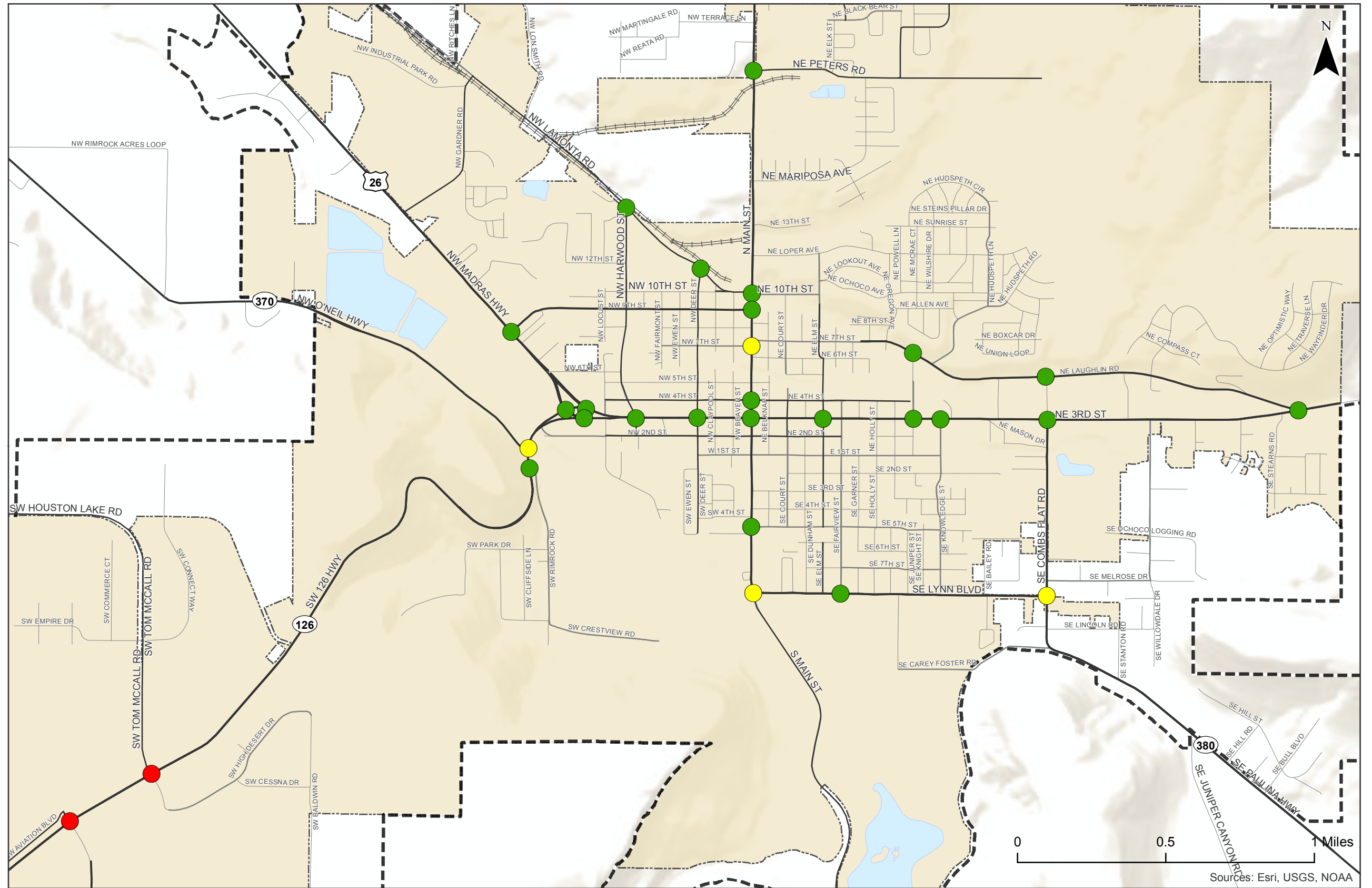

**Study Intersections Operations for 2nd and 3rd Street Couplet
City of Prineville, Oregon**

**Figure
6-8**

K:\H_Portland\profile12221 - Prineville TSP\GIS\Memo 618-6 Study Intersections Operations for 2nd and 3rd Street Couplet.mxd - openbrd - 6:39 PM 5/3/2013

- **Economic Impact:** Each alternative was evaluated by considering how businesses would be impacted by construction or right-of-way acquisition, parking availability, and pass-by traffic volume. Widening 3rd Street was given a low score (no star) based on the right-of-way impacts to businesses in the 3rd Street corridor. The couplet alternatives were also given low scores due to the rerouting of traffic onto adjacent streets. Parallel routes were given half stars to reflect a moderate impact on businesses due to diverting a portion of existing traffic away from 3rd Street. Brummer Road was given a lower score due to its potential to reroute trips around the City entirely.
- **Social Impact:** Alternatives were evaluated to determine their social impact on the community, as measured primarily by the amount of right-of-way impacts on businesses and residential properties. An empty star indicates significant social impacts while a full star indicates little to no impacts.
- **Environmental Impact:** Alternatives were evaluated for their environmental impact, which includes impacts to parks, creeks, and natural terrain. An empty star indicates significant impacts while a full star indicates little to no impacts.
- **Operational Impact:** Alternatives were evaluated for their ability to mitigate congestion on 3rd Street. Each alternative was given a low, medium, or high score based on the delay mitigated at the intersection of 3rd Street and Main Street as follows:
 - Low Operational Impact (empty star): No decrease in control delay.
 - Medium Operational Impact (half star): Less than five seconds decrease in control delay.
 - High Operational Impact (full star): More than five seconds of decrease in control delay.

An average star value was calculated for each alternative that was used to establish an overall score for each alternative. The alternatives with the highest average number of stars were assigned a full star. The alternatives with the lowest average star values were assigned an empty star.

Table 6-1 summarizes the relative ranking of each alternative for the five criteria. As shown in the table, the Peters Road Extension is expected to have the greatest operational benefit relative to its various impacts to the City.

Table 6-1 3rd Street Corridor Alternatives Summary

	Evaluation Criteria					Total Score
	Construction Cost	Business Impact	Social Impact	Environmental Impact	Operational Impact	
Parallel Routes						
<i>9th Street Extension</i>	★	★	★	★	★	★
<i>Peters Road Extension</i>	★	★	★	★	★	★
<i>Combs Flat Road Extension</i>	★	★	★	★	★	★
<i>Brummer Road</i>	★	★	★	★	★	★
<i>Crestview Connection</i>	★	★	★	★	★	★
2nd/3rd St Couplet	★	★	★	★	★	★
3rd/4th St Couplet	★	★	★	★	★	★
Corridor Widening	★	★	★	★	★	★

Based on review of the three options, we recommend that the City focus its investments on a system of parallel routes to meet travel needs through 2035. We provide this recommendation for the following reasons:

- The improvements to the City roadway network would be required under any scenario as they serve developable lands, provide travel options, and better enable multimodal travel.
- The parallel roadways meet the 20-year needs for the lowest overall cost of the alternatives reviewed, and will be the most likely alternative to be achieved given the current City and State funding.
- This alternative does not preclude development of other alternatives that may be needed to serve growth beyond the 20-year horizon; these options will remain viable if growth outpaces the 20-year projections.

Main Street Corridor

As previously identified, the Main Street corridor serves a critical north-south travel function in Prineville and has limited alternative routes. The existing four-lane cross-section between 9th Street and Peters Road transitions to a three-lane section in the downtown area, and continues south with a three-lane section to 1st Street.

The City is currently pursuing design and construction plans that will convert the four-lane section of this road to provide a single travel lane in both directions and a continuous center median. This narrowed section will allow space for bicycle lanes to better accommodate non-motorized travel. The project will also improve the traffic signal at 10th Street and install a new traffic signal at 9th Street, pending adequate funding.

While these improvements help to improve multi-modal travel, the critical issue with Main Street is the reliance on this route for all north-south travel. New connections, such as a northerly extension of Combs Flat Road to Peters Road, and a western extension of Peters Road to Lamonta Road, will help reduce this reliance and lessen congestion on this route. The completion of these

parallel routes, as identified in the functional classification section, are shown to adequately mitigate this overall corridor.

Project Needs:

- Completion of signalization/improvement plans at the Main Street/9th Street and Main Street/10th Street intersections
- Completion of the three-lane section north of 9th Street

Combs Flat Corridor

The Combs Flat Road corridor south of 3rd Street (OR 380) provides access to recreational and residential areas to the south. Within City limits Combs Flat Road transitions from a rural State facility into a City roadway connecting the commercial areas along 3rd Street and into residential lands in the Iron Horse development.

The designated highway portion of this route is generally rural throughout its length south of 3rd Street, with no designated pedestrian amenities but striped bicycle lanes along the shoulders. The corridor borders or provides access to several schools and residences, and is located adjacent to the Ochoco Lumber site that is planned for mixed-use development. While there are specific intersection improvement needs, the general need is for Combs Flat to include turn lanes at major intersections, and pedestrian and bicyclist facilities throughout its length. The desire to develop the Ochoco Lumber site as a vibrant, mixed-use area will require that the barrier effects of Combs Flat Road be reduced, to integrate this portion of the City with the downtown.

The extension of Combs Flat Road north will also require additional improvements to the built section of the facility. The two-lane section that connects through the commercial area will likely require widening to three lanes along with modal accommodations, and new turn lanes will be required at the 3rd Street/Combs Flat Road intersection and at the intersection with Laughlin Road. Depending on the growth within Iron Horse, signalization of the Laughlin Road intersection with Combs Flat may also be required.

Project Needs:

- Left-turn lanes at major intersections, such as Laughlin Road, 3rd Street, a future extension of 5th Street, and Lynn Boulevard.
- Pedestrian crossing considerations, particularly at the Ochoco Creek Trail, the future 5th Street extension, and at Lynn Boulevard.
- Pedestrian and bicyclist facilities throughout the length of the corridor.
- Potential capacity improvements at 3rd Street and at Laughlin Road.

OR 126 (west of US 26)

The OR 126 Corridor Facility Plan identifies the need to widen OR 126 to provide a four-lane section from Tom McCall Road to the Prineville “Y” junction. East of Millican Road, the additional traffic demand from the development of the adjacent industrial lands was projected to require two travel lanes in each direction into Prineville. With the revised volume forecasts, the existing cross-section is expected to provide adequate capacity through 2035.

Therefore, previously identified widening needs are no longer required from a capacity perspective.

Alternative Mobility

A component of any improvement options should include consideration of alternative mobility. These policies allow higher levels of congestion to delay or avoid major capital costs. Generally, State facilities that serve a regional function in addition to their local role are the facilities most likely to experience congestion. Within Prineville, US 26 (Madras-Prineville Highway and 3rd Street) and OR 126 (Ochoco Highway) carry the highest traffic volumes and experience the highest levels of congestion. State facilities are generally required to provide high levels of reserve capacity in a 20-year horizon. Options to modify this requirement include the following:

- Designation of the highway as Urban Business Area (UBA) or Special Transportation Area (STA). Currently, sections of 3rd Street in the downtown area have the STA designation.
- Removal of the Expressway Classification. A portion of OR 126 near the airport contains the expressway designation, providing a higher mobility goal.
- Identification of other analysis periods, seasons, or hours. By default, analysis of ODOT facilities is focused on the peak fifteen minute period of the 30th highest annual hour 20 years into the future. Options are available to consider other periods if this standard cannot be met.

While there are different options to change the mobility requirements, on ODOT facilities this can only be accomplished as part of a legislative effort, and cannot occur as part of a private development application.

INTERSECTION ALTERNATIVES

Intersection Improvements

This section summarizes specific “point” improvements at intersections and junctions throughout the City, based on operational, safety, or geometric needs.

OR 126/Tom McCall Road/Millican Road

The OR 126 Corridor Facility Plan identified the need for an interchange at the OR 126/Tom McCall Road intersection and realignment of Millican Road to connect as a new southern intersection leg in the 2035 horizon year. The analysis showed that with the projected growth,

which was considered conservative, an at-grade stop controlled intersection would continue to operate below capacity but beyond ODOT mobility targets.

Using the revised travel demand forecasts for 2035, growth projections were significantly reduced relative to the forecasts used in the OR 126 Corridor Facility Plan. These reduced projections show that while an interchange may remain a long-term need, an at-grade intersection will meet mobility targets in the horizon year. Table 8-3 of the OR 126 Corridor Facility Plan identifies phased improvements at the OR 126/Tom McCall Road intersection that include:

- Install left-turn lanes on OR Highway 126
- Extend the westbound right-turn lane
- Add a southbound right-turn lane on Tom McCall Road
- Add a new traffic signal at the intersection, along with approach treatments to account for the high speeds and rural environment
- Install frontage road connections to the airport

A second option identified in the OR 126 Corridor Facility Plan was to realign Tom McCall Road with Millican Road and install a multi-lane roundabout. The corridor plan noted that this was a more challenging project to phase and would require much of the cost up-front. In addition, when the OR 126 Corridor Facility Plan was being developed, the roundabout conflicted with ODOT policies. The relative safety benefits of a roundabout relative to a signal warranted keeping a roundabout in the corridor plan as an alternate treatment should the funding for the roundabout become available and ODOT policy changes occur.

Since adoption of the OR 126 plan, ODOT policy was revised to allow roundabouts on state highways, with the requirement that appropriate stakeholder outreach was provided with the freight community to ensure that the roundabout sizing was adequate to accommodate the dimensional needs of trucks.

The City and ODOT have been in discussions and ODOT is working to conduct a detailed evaluation of traffic control options at the intersection.

Project Needs:

- Coordinate with ODOT to conduct a traffic control evaluation.
- Construct either a signal or roundabout to improve minor-street capacity and delay.

West "Y"

The OR 126 Corridor Facility Plan identified the need to extend queue storage on the stop-controlled approach for eastbound OR Highway 126 to westbound US 26 traffic. The plan also included long-term identification of either a traffic signal or multilane roundabout; either could provide acceptable operations.

With the revised growth forecasts for OR 126 the existing traffic control will be adequate to accommodate the 20-year growth projections. Some improvements may continue to be required

(such as the interim queue storage enhancements), but the overall demands can be lessened with other planned connections as previously described.

O'Neil Hwy/OR 126

The OR 126 Corridor Facility Plan identified the need to restripe the Crooked River bridge and channelize the eastbound through lane at the O'Neil Highway/OR 126 intersection as an interim treatment, with the likely relocation of the O'Neil Highway connection. A concept of the channelization was prepared for the Corridor Plan project and is provided in Technical Memorandum #6, Appendix F.

This improvement will be needed initially to reduce delay for minor-street vehicles. By 2035, volume is expected to exceed capacity unless this improvement is constructed. For plan purposes, an alternate alignment of the O'Neil Highway is recommended to be retained. The current location of the intersection along the grade provides high-speed conflicts on an inclined pavement section, and highway curvature limits the ability for motorists to adequately judge the speed and presence of oncoming vehicles.

As discussed within the pedestrian section, the more critical component of this intersection is the need to provide pedestrian crossings, as the location of the jersey barriers currently prevents legal crossings and connections to the trail system.

Project Needs:

- Channelize eastbound through movement and restripe Crooked River Bridge to four lanes to provide a two-stage gap for minor-street left-turn vehicles.
- Pedestrian crossings to the adjacent view point trails.

Peters Road/Main Street

A spur line serving the Woodgrain Millwork site crosses Main Street immediately south of its connection with Peters Road. While the at-grade crossing does not include active gates or lights and currently requires flaggers on Main Street for traffic control, future improvements at the intersection of Main Street and Peters Road should accommodate this crossing and its potential for higher use.

Combs Flat Road/Lynn Boulevard

A significant amount of growth is projected to occur outside of the City, and with the completion of the 2nd Street extension a higher volume of traffic is utilizing Main Street and Lynn Boulevard to provide this connection. Growth along Combs Flat Road is also influenced by the nearby schools, and experiences high peaking characteristics.

It is recommended that this intersection be signalized when warranted. The need and timing of this improvement will be driven by growth, and should be monitored as part of development applications that would create an impact.

Main Street/Lynn Boulevard

Similar to the intersection of Combs Flat Road and Lynn Boulevard, the need to signalize the intersection of Main Street and Lynn Boulevard will be driven by growth in southern Prineville, particularly within the Anglers' Canyon development or any other development that connects to the south. This intersection should be planned for future signalization, with a traffic signal installed only when warranted.

Harwood Avenue/Lamonta Road

The intersection of Harwood and Lamonta Road provides an unconventional geometry, as shown within the inset. The intersection contains only single turn lanes, but dual receiving lanes for southbound traffic along with a very short merge area. Restriping to provide a single southbound travel lane and better delineation of the radius would address the intersection needs.



OR 126/US 26 - 3rd Street/Laughlin Road

The connection of Laughlin Road with US 26/OR 126 – 3rd Street forms a skewed intersection with a separate westbound “slip lane” treatment. Regardless of whether the City completes the 9th Street extension, it is recommended that this intersection be reconfigured as a more conventional perpendicular “T” intersection. This design will provide lower and consistent turning speeds, and provide a single and more defined connection to the highway, and reduce pedestrian and bicyclist conflicts.

Intersection Realignment

There are several locations in Prineville where roadways are poorly aligned, or segments of roadway are missing. Intersection alignment helps improve safety, simplifies driver decisions, and provides more continuous routes. A complete grid network provides travelers with options and better accommodates pedestrian and bicycle trips by making them more direct. The locations noted are as follows:

- 10th Street and Lamonta Road: These two roadways intersect at a sharp angle, making visibility more difficult. It is recommended that 10th Street be curved north to intersect with Lamonta Road at a perpendicular, stop-controlled approach. This would preserve Lamonta Road as the through route.

- The Lamonta Road/10th Street intersection with Main Street is offset by approximately 10 feet. This alignment will be addressed through the City's current design project.

SAFETY ALTERNATIVES

The existing conditions analysis documented in Technical Memorandum #3 noted that ODOT has designated 3rd Street (US 26/OR 126) as a safety priority area based on the high incidence of crashes in comparison with other similar facilities. Other locations identified for further safety review include the intersections of Main Street and 9th Street, Main Street and 4th Street, and Deer Street and 2nd Street.

Based on the analysis of crash history from 2007 through 2011, as summarized in Memo #5, one segment and several intersections were identified for diagnosis and countermeasure selection. Key factors estimated to contribute to crashes are summarized in 0, based on review of crash history, intersection geometry, and traffic control.

A range of low-cost countermeasures were considered to address the crash patterns and trends observed over the study period. Detailed summaries of crash patterns and suggested countermeasures for each location are provided below.

Table 6-2 Crash Countermeasure Alternatives

Location	Crash Contributing Factors	Potential Crash Countermeasures
N 3 rd Street: Maple to Claypool	Frequent driveways resulting in conflicts.	Reduce density to XX driveways/mile by consolidating or restricting turning movements. Install raised median to restrict turn movements.
N 3 rd Street/ Harwood Street	11 of 14 crashes were rear-end crashes.	Reduce congestion and minimize driveways on N 3 rd Street.
N 3 rd Street/ Combs Flat Road	7 of 18 crashes involved turning vehicles. 7 crashes resulted in injury.	Change left-turn signal timing from protected-permitted to protected-only on east-west approaches.
Main Street/ N 4 th Street	9 rear-end crashes reported. Congestion at the N 3 rd Street/Main Street intersection	Reduce congestion at N 3 rd Street/Main Street intersection that queues through N 4 th Street. Pedestrian crossing treatments (crosswalk visibility, curb bulb-outs, etc.) Consider southbound advanced intersection warning sign that indicates "congestion ahead" or similar.
N 2 nd Street/ Deer Street	4 angle crashes resulted when the driver "did not yield right-of-way" and 4 other angle crashes resulted when the driver "passed stop sign or red flasher."	Increase sign visibility through one or more of the following: replace the stop sign with a larger size sign, install retroreflective tape on the sign post, or add LED lights to the sign border. Convert traffic control to all-way stop

N 3rd Street

There are eight private driveways within a 900 foot section of N 3rd Street from Maple Street to Claypool Street. Studies indicate that reducing access density can reduce crash frequency. The majority of crashes within the 3rd Street corridor were rear-end crashes, which indicates that access management could be the most effective treatment. Increasing capacity at signalized intersection may also reduce the number of rear-end crashes.

Main Street at 9th Street

Project planning is underway to improve the Main Street intersections with 9th Street and 10th Street. The project is considering ways to improve the new 9th Street connection between US 26 and Main Street and how this connection can tie in with the nearby signalized connection of 10th Street – Lamonta Road. This project will be addressing the poor truck accommodations along this route, pedestrian connectivity and accessibility needs, and safety along the overall Main Street corridor between 9th Street and Peters Road.

The first phase of the project will include identification of the long-term needs and costs, with implementation in the second phase. It is unknown if the current funding will allow all the needed improvements to be constructed, or if additional funding will be required.

Main Street at 4th Street

Over the 5-year study period from 2007 through 2011, 12 crashes were reported at the Main Street and 4th Street intersection. Relative to the number of vehicles entering the intersection, the crash rate exceeds the statewide performance threshold (90th percentile). The majority of crashes are rear-end crashes (9 total). Congestion at the N 3rd Street/Main Street intersection, pedestrian

activity, and on-street parking are likely contributing factors to the five reported southbound rear-end crashes that occurred on the north leg of the intersection. No geometric or traffic control changes are expected to address rear-end crashes on Main Street, but the City could consider advanced warning or indications to drivers. Implementation of improvements to signal timing and other alternatives to manage traffic on 3rd Street are expected to reduce congestion at this intersection.

Mitigation options could include the following:

- Curb bulb-outs on the corners to define the intersection, reduce speeds, delineate on-street parking areas, and increase visibility of pedestrians waiting to cross the road.
- Improve visibility crosswalk treatments (such as piano striping on the north-south approaches to replace the parallel lines)
- Tinted/colored crosswalks to improve intersection visibility.

N 2nd Street at Deer Street

The crash rate (1.17 crashes per million entering vehicles) at the N 2nd Street/Deer Street intersection is the highest of all study intersections reviewed and exceeds the statewide performance threshold. The ten reported crashes include eight angle crashes, one rear-end, and one other/unknown crash type. Crash reports indicate one or more persons were injured in eight of the crashes. No other intersection has a higher proportion of injury crashes than this intersection.

Based on limited information provided within the crash data, four angle crashes resulted when the driver “did not yield right-of-way” and the other four angle crashes resulted when the driver “passed stop sign or red flasher.” These contributing factors suggest drivers are not stopping at the stop sign, are not yielding to major-street traffic, or cannot adequately see oncoming cars when entering the intersection. With the recent completion of the 2nd Street connection to OR 126 the east-west volume has increased along this route, and Deer Street is one of a limited number of signalized intersections with 3rd Street.

Mitigation options include the following:

- Replacing the stop sign with a larger size sign.
- Installing retroreflective tape on the sign post, or adding LED lights to the sign border to increase sign visibility.
- Providing curb bulb-outs to better highlight the intersection area and define the on-street parking areas.
- Striping higher visibility crosswalks (such as piano striping)
- Adding “STOP” striping on the east-west approaches.
- Converting the intersection to an all-way stop.

ACTIVE TRANSPORTATION ALTERNATIVES

Active transportation options, including walking and bicycling, are transportation alternatives that not only provide physical benefits to people but also reduce traffic and congestion on

roadways. In order for people to choose walking and bicycling as viable modes of transportation, adequate facilities are needed to provide separation from motor vehicles and connectivity throughout the City.

Pedestrian Facilities Plan

Pedestrian facilities serve a variety of needs, including:

- Relatively short trips (generally considered to be under a mile) to major pedestrian attractors, such as schools, parks, and public facilities;
- Recreational trips (e.g., jogging or hiking) and circulation within parks;
- Access to transit (generally trips under 1/2 –mile to bus stops); and,
- Commute trips, where mixed-use development is provided and/or people have chosen to live near where they work.

Pedestrian facilities should provide continuous connections among neighborhoods, schools, employment areas, and nearby pedestrian attractors. Pedestrian facilities usually refer to sidewalks or paths, but also include pedestrian crossing treatments for high volume roadways.







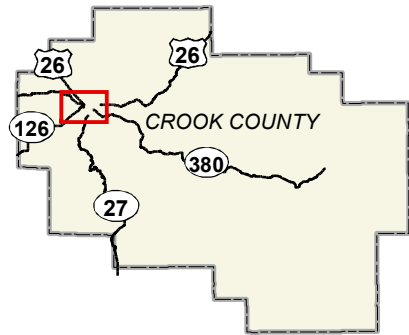





Within Prineville, sidewalks are provided on one or both sides of some of the major roadways. Noticeable gaps in the sidewalk exist along Main Street and within the vicinity of local schools, as summarized in Technical Memorandum #3. Existing pedestrian facilities within the City are shown in Figure 6-9.

Future plans for improvements to the pedestrian system are focused on strategic improvements to improve east-west and north-south connectivity throughout the City, improvements to connectivity between residential areas and schools as identified in the Safe Routes to School Action Plans for local schools, and trail improvements and connectivity identified within the Crook County Parks and Recreation District Master Plan. Multi-use trail improvements will be discussed in the multi-use trails section.

The Safe Routes to School Action Plans for Cecil Sly Elementary, Crooked River Elementary, and Crook County Middle School identified several locations needing improved pedestrian and bicycle connectivity in the southeast area of the City. Specifically, the plans called for connectivity to residential areas north of Laughlin Road by adding sidewalks along Juniper Street, Laughlin Road, Hudspeth Lane, and Oregon Street. Marked pedestrian crossings of Laughlin Road and 3rd Street are also needed to facilitate safe crossings in these locations. Additional signage and lighting should be considered to increase visibility of pedestrians to approaching drivers at crosswalks.



Destinations

-  Airport
-  Fairgrounds
-  Golf Course
-  Hospital
-  Library
-  Pool
-  School
-  Skatepark
-  Park
-  Proposed Crosswalk
-  Proposed Sidewalks
-  City Boundary
-  Study Area/Urban Growth Boundary (UGB)

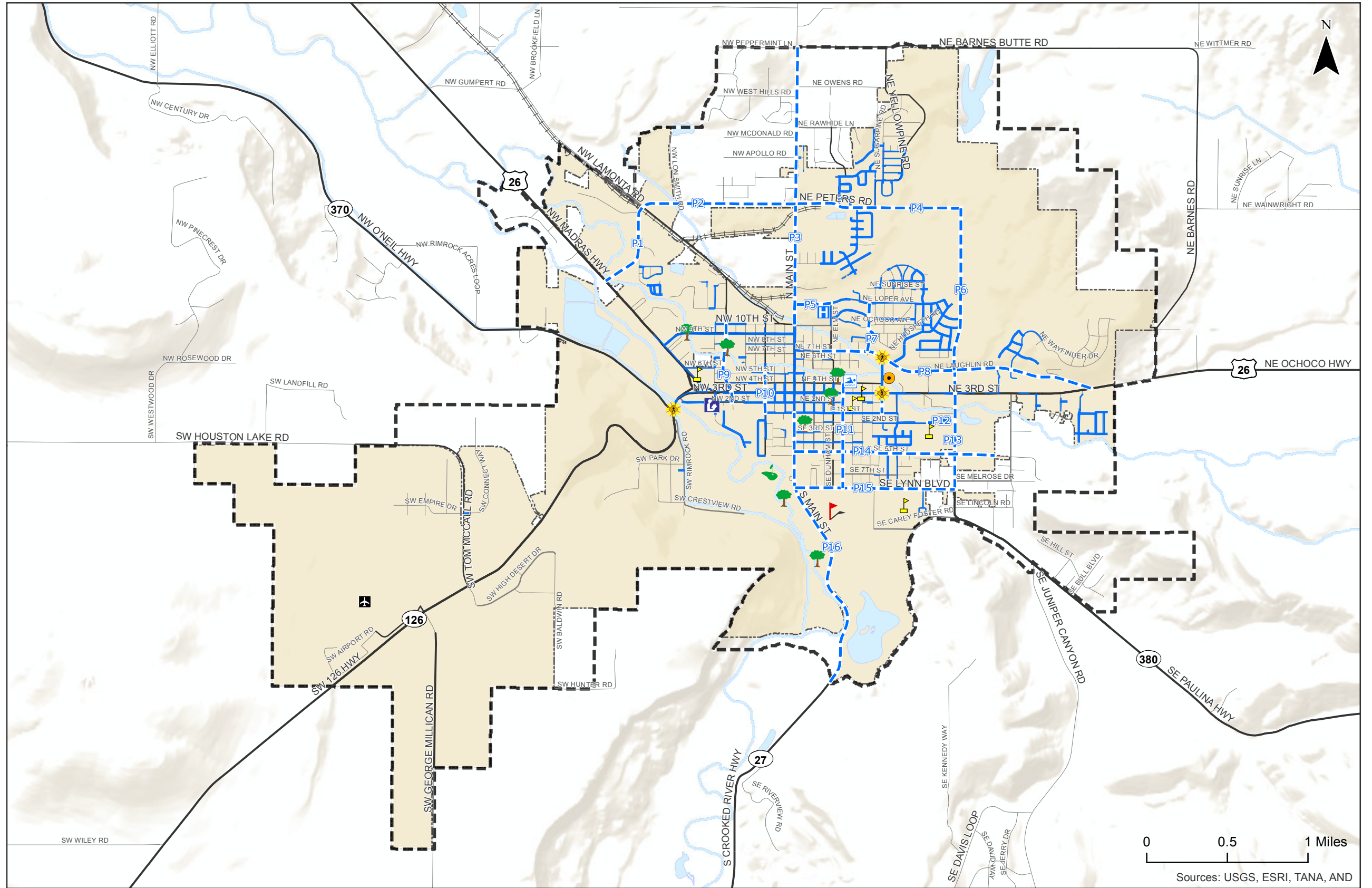

**Proposed Pedestrian Facilities
City of Prineville, Oregon**

**Figure
6-9**

H:\projects\12221 - Prineville TSP\GIS\Memo 616-9 Proposed Pedestrian Facilities.mxd - jsommerville - 2:55 PM 5/3/2013

Figure 6-9 shows the location and extent of the planned pedestrian improvements relative to the existing pedestrian facilities within Prineville. Based on current lack of east-west and north-south connectivity as well as connections between residential areas and schools, the priority segments for pedestrian improvements include:

- Combs Flat Road: Add sidewalk on both sides of the street to provide facilities for students using Combs Flat Road to walk to school.
- Lynn Boulevard: Add sidewalk on both sides of the street.
- Juniper Street: Add sidewalk on Juniper Street between 3rd Street and E 1st Street.
- Main Street: Provide sidewalk on both sides of the street from Lynn Boulevard north to Peters Road to provide a continuous north-south connection.
- SE 5th Street: Add continuous sidewalk on both sides of the street, extending east to Ochoco Logging Road.
- 3rd Street/Juniper Street: Add a pedestrian crossing in this area to connect residential areas from the north to the schools south of 3rd Street. Consider a high visibility crosswalk, signage, and/or pedestrian signals to raise visibility of pedestrians.
- Juniper Street/Laughlin Road: Add a pedestrian crossing to provide a safe crossing to residential neighborhoods north of Laughlin Road.
- Provide a pedestrian crossing or underpass near the intersection of O'Neil Highway and OR 126.

Bicycle

Similar to pedestrian facilities, bicycle facilities (including dedicated bicycle lanes in the paved roadway, multi-use paths shared with pedestrians, etc.) serve a variety of trips. These include:







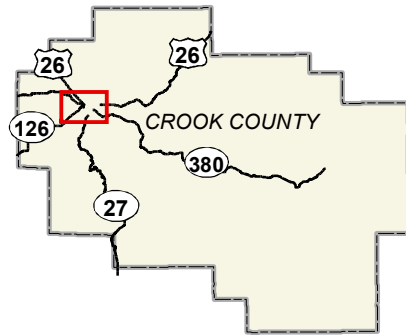







- Trips to major attractors, such as schools, parks and open spaces, retail centers, and public facilities;
- Commute trips;
- Recreational trips; and,
- Access to transit, where bicycle storage facilities are available at the stop, or where space is available on bus-mounted bicycle racks.

Bike lanes and shared bicycle shoulders are currently provided in relatively limited areas scattered throughout the City. Existing bicycle facilities within Prineville are located on portions of 3rd Street, Main Street, Combs Flat Road, OR 126, and 9th Street. Other bicycle travel within the urban area occurs on facilities where bicycles can safely be accommodated with vehicular traffic or on existing multi-use pathways. Future plans for multi-use paths are summarized in the following section. Technical Memorandum #3 describes the existing bicycle network.

The City's map of planned bicycle projects displays future opportunities for creating a connected bicycle network. Bicycle facilities should be constructed on new collectors and arterials built within the City. In addition, bicycle facilities should be added on existing roadways when feasible to provide added connectivity throughout the City. Figure 6-10 shows existing bicycle facilities relative to planned bicycle facilities and how these routes will create a connected network.



Destinations

-  Airport
-  Fairgrounds
-  Golf Course
-  Hospital
-  Library
-  Pool
-  School
-  Skatepark
-  Park
-  Proposed Bike Lanes
-  Existing Bike Lane
-  Existing Bike Route
-  City Boundary
-  Study Area/Urban Growth Boundary (UGB)

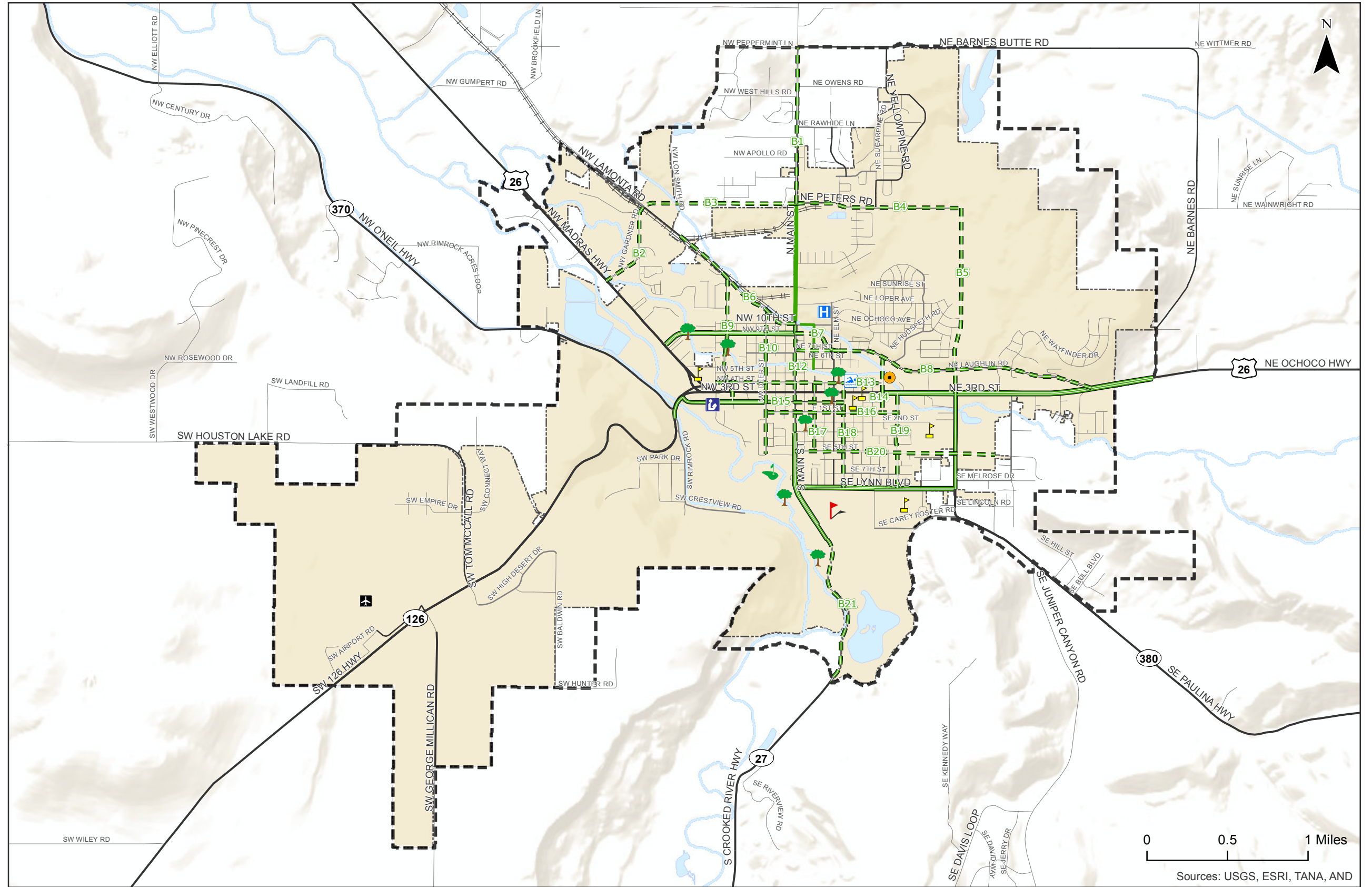

**Proposed Bicycle Facilities
City of Prineville, Oregon**

**Figure
6-10**

H:\proj\12221 - Prineville TSP\GIS\Memo 6/6-10 Proposed Bicycle Facilities.mxd - 4:21 PM 5/9/2013

The proposed bicycle facilities were developed by determining where existing gaps in bicycle facilities were located, where additional east-west or north-south connectivity was needed, and where connectivity to local schools was requested in the Safe Routes to School Action Plans.

Several projects were identified as high priority projects based on their ability to provide increased connectivity within the City and between residential areas and schools. These routes include many of the future connections shown on the east side of the urban area. The priority routes for constructing bike lanes include:

- Knowledge Street: Add a bicycle lane to provide connectivity with local schools.
- Juniper Street: Add a bicycle lane to provide connectivity between residential neighborhoods and schools.
- Laughlin Road: Add a bicycle lane to provide alternative east-west connectivity and connectivity to residential areas of the City.
- Main Street: Construct continuous bicycle lanes within the UGB to provide a north-south route for bicyclists.
- 2nd Street or 4th Street: Provide continuous bicycle lanes to provide an east-west route parallel to 3rd Street.

Multi-Use Paths







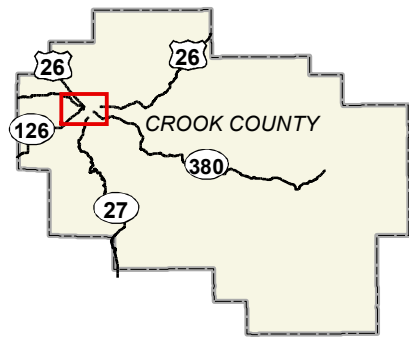







Multi-use trails provide pedestrians and bicyclists with a path separated from motor vehicles. The City currently has a multi-use path that runs along the Ochoco Creek between Harwood Avenue and Juniper Street. In addition, there is a multi-use path that runs along US 26, as shown in Figure 6-11. As discussed in the Crook County Parks and Recreation District Master Plan, the City hopes to provide a connected network of trails and greenways along the Ochoco Creek, McKay Creek, and the Crooked River. The Master Plan calls for an additional 7 miles of pathways and 7 miles of trails. In addition, the plan encourages the City to look for opportunities to provide trails in existing developments or new development.

Figure 6-11 shows existing multi-use trails within the City as well as key multi-use trail connections shown in the Master Plan. In order to achieve the City's goal of providing a continuous trail network, the following have been identified as priorities for the trail system:

- Add a crossing or underpass of OR 126 near the intersection of O'Neil Highway where trail M1 begins.
- Add a crossing of 3rd Street near the intersection of Knowledge Street where the existing multi-use trail crosses 3rd Street to increase the safety of pedestrians and bicyclists using the trail. Features such as high visibility crossings, signals, and signage should be considered to raise visibility.
- Add a crossing of Combs Flat Road and continue the trail east through the former Ochoco Lumber site.



Destinations

-  Airport
-  Fairgrounds
-  Golf Course
-  Hospital
-  Library
-  Pool
-  School
-  Skatepark
-  Park
-  Proposed Crosswalk
-  Existing Multi-Use Path
-  Proposed Multi-Use Path
-  City Boundary
-  Study Area/Urban Growth Boundary (UGB)

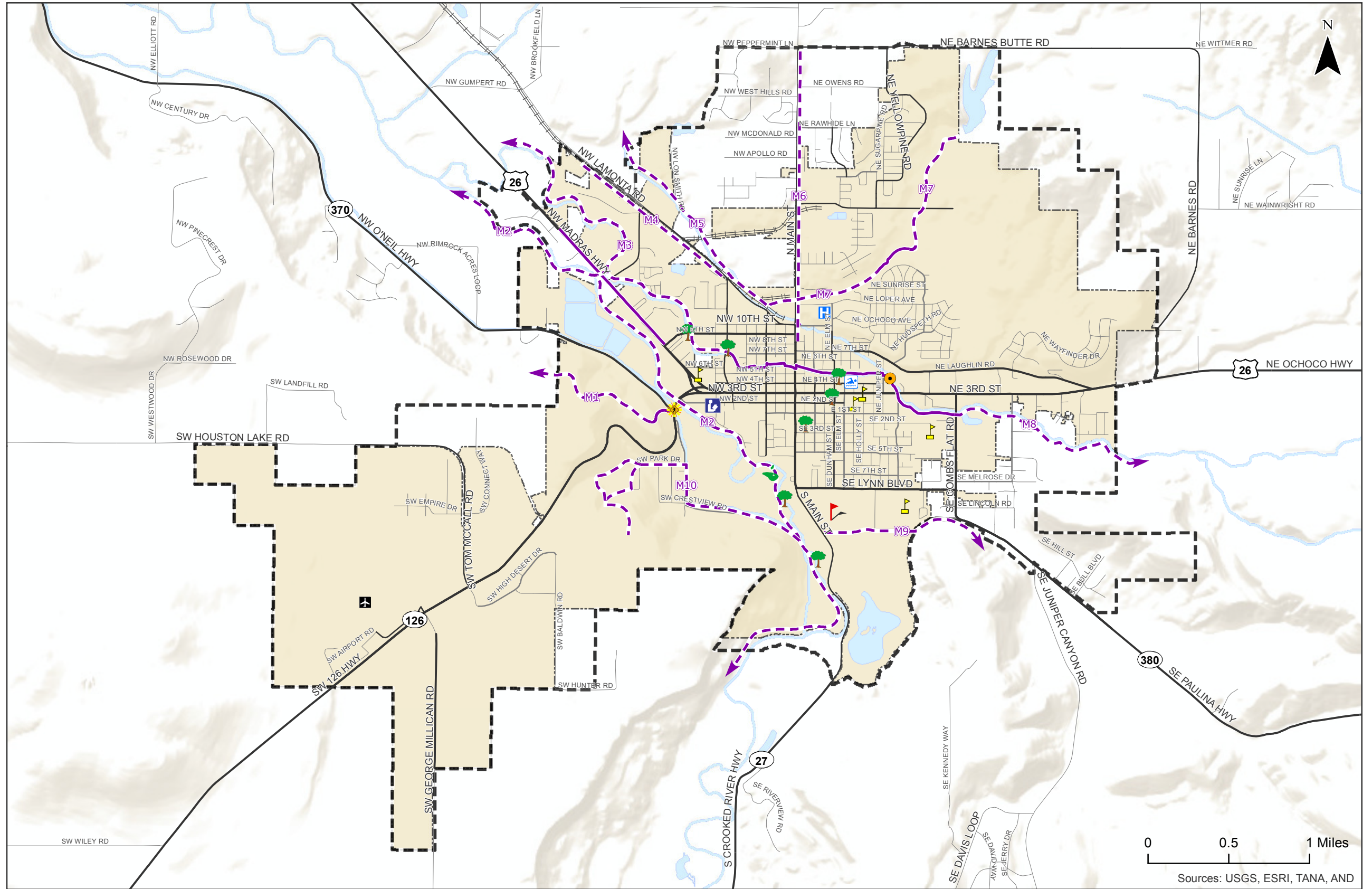

Sources: USGS, ESRI, TANA, AND

**Proposed Multi-Use Trails
City of Prineville, Oregon**

**Figure
6-11**

H:\proj\12221 - Prineville TSP\GIS\Memo 616-11 Proposed Multi-Use Trails.mxd - jsomerville - 4:31 PM 5/3/2013

FREIGHT

Freight connections to the City of Prineville includes the highway system (OR 126 and US 26 are designated freight routes) and the City of Prineville Railway (COPR). The COPR system provides a 18-mile shortline service between the City and the Class 1 BNSF mainline in Redmond, with daily switching operations at the Prineville Junction located just north of Redmond along the US 97 corridor.

Roadway Freight

US 26 and OR 126 are designated as freight routes west of the Prineville “Y”, but where the highways join the freight route designation is removed. Despite removal of this designation, truck volumes are a considerable component of the highway traffic in Prineville:

- US 26 west of Prineville: 30% trucks (14% single unit trucks)
- OR 126 west of Prineville: 23% trucks (15% single unit trucks)
- 3rd Street (US 26/OR 126): 23% trucks (14% single unit trucks)
- Combs Flat Road (OR 380): 17% trucks (13% single unit trucks)
- O’Neil Highway (OR 370): 23% trucks (14% single unit trucks)
- US 26 east of Prineville: 30% trucks (15% single unit trucks)
- OR 27 south of Prineville: 11% trucks (5% single unit trucks)

Based on the volume of freight traffic, it is recommended that design features of the highways account for the dimensional and maneuvering needs of truck traffic despite the lack of designated freight or truck routes within the City. It is recommended that a City of Prineville Truck Route designation is provided along all of the highways.

In addition, the following local streets should also be designated as City freight routes based on the land uses served and connections provided:

- Main Street between Peters Road and the southern City boundary
- Lamonta Road
- 9th Street from US 26 to Main Street

Rail Freight

With the closure of the Ochoco Mill, the City of Prineville recently abandoned a City-operated spur rail line between Main Street and Combs Flat Road, converting the right-of-way into a trail. The abandonment of this rail line removed eight at-grade rail crossings within the City, including a crossing of US 26, Combs Flat Road (OR 380), and Main Street.

Despite the abandonment of the spur line, the City has increased its investment in the COPR shortline service to the Prineville Junction. With assistance from Connect Oregon grants, the City has recently completed construction of a freight depot, which provides significant warehousing space, equipment ramps, freight to rail intermodal service, and bulk product storage. The site is located along Bus Evans Road between Lamonta Road and US 26, approximately two miles west of the City.

The location of this site further justifies the City freight route designation of Lamonta Road, and will also require coordination with Crook County for the portion of Lamonta Road located outside of City limits.



AIRPORT

Proposed connections between Tom McCall Road and Airport Road will provide off-highway connectivity to improve integration of the business park with the airport. Additionally, airport traffic will have improved access to OR 126 with traffic control improvements proposed at the Tom McCall Road intersection. The City and Crook County are preparing to update the airport masterplan, which will identify additional improvement needs over the planning horizon.

FUNDING PROGRAMS

Funding for the implementation of the projects identified in the Transportation System Plan will be shared between the City of Prineville, Crook County, ODOT, private development, and potentially through volunteers and other interests. The proportional contributions are to be determined at the time that development occurs or some land use change triggers the need for implementation. Contributions of each agency, if any, should reflect facility users' residence and the project's function. Facilities that are wholly located within the City, but utilized by County residents during daily commutes or to access necessary city amenities should include County contributions.

To assist with the future implementation efforts, this section outlines the existing revenue stream for transportation funding in the City of Prineville and potential funding sources.

Estimated Revenue

The City of Prineville has two primary sources for allocating funding for transportation projects: the Transportation SDC Fund and the Transportation Fund. The Transportation SDC Fund accounts for the receipt and expenditures of revenues to construct collector and arterial street improvements and is funded by SDC fees assessed on new development.

The primary sources of revenue for the Transportation Fund have been the State of Oregon gas tax and, to a lesser extent, state revenue sharing and the STP fund exchange program. Recognizing the impact that the installation of public utilities have on the need for street repairs, the City of Prineville recently established two new revenue sources for the Transportation Fund: franchise fees from the City's water and wastewater funds. The Transportation Fund covers the City's street, bike lane, right-of-way, and storm water maintenance.

Table 6-3 summarizes transportation-related resources and expenditures for the past three fiscal years as well as projections for the most recent fiscal year, which ended June 2013.

Table 6-3 Transportation Revenue

	FY 09-10	FY 10-11	FY 11-12	FY 12-13
Transportation SDC Fund Resources	\$67,621	\$199,206	\$90,400	\$150,800
Transportation SDC Fund Expenditures	\$167,256	\$532,302	\$114,200	\$167,500
Transportation Fund Resources	\$888,715	\$922,794	\$903,661	\$939,000
Transportation Fund Expenditures	\$972,131	\$888,917	\$1,155,300	\$1,161,900

Based on the information provided in Table 6-3, the city has collected an average of \$1.04 million per year in revenues (SDC and Transportation Fund) and expended approximately \$1.3 million on average per year. Based on the past few years, the city may expect to collect approximately \$25 million in transportation revenue over the next twenty years.

Local Funding Mechanisms

At the local level, the City can draw on a number of potential funding mechanisms to help finance the TSP improvements.

As properties with road frontage develop, developers are currently required to build the road frontage along their property consistent with City standards. This allows the transportation system to be developed incrementally at the same time as land develops. Property owners are only required to pay for improvements in proportion to the development’s impact on the transportation system.

Table 6-4 outlines other potential funding sources at the local level that could be implemented in the future in the City of Prineville. In general, local funding sources are more flexible than funding obtained from state or federal grant sources.

Table 6-4 Potential Local Funding Mechanisms

Funding Source	Description	Potential Application in Prineville
User Fee	Fees tacked on to a monthly utility bill or tied to the annual registration of a vehicle to pay for improvements, expansion, and maintenance on the street system.	Preliminary street improvements
Street Utility Fees/Road Maintenance Fee	The fee is based on the number of trips a particular land use generates and is usually collected through a regular utility bill.	System-wide transportation facilities including streets, sidewalks, bike lanes, and trails
Stormwater SDCs, Grants, and Loans	Systems Development Charges, Grants, and Loans obtained for the purposes of making improvements to stormwater management facilities.	Primarily street improvements
Local Gas Tax	A local tax assessed on the purchase of gas within the City. This tax is added to the cost of gasoline at the pump, along with the state and federal gas taxes.	System-wide transportation facilities including streets, sidewalks, bike lanes, and trails
Optional Tax	A tax that can be used to fund improvements, and gives the taxpayer the option to pay. Generally paid at the same time other taxes are collected, optional taxes are usually less controversial and easily collected since they give the taxpayer a choice whether or not to pay the additional tax.	System-wide transportation facilities including streets, sidewalks, bike lanes, trails, and transit
Public/Private Partnerships	Public/private partnerships have been used in several places around the country to provide public transportation amenities within the public right-of-way in exchange for operational revenue from the facilities. These partnerships could be used to provide services such as charging stations, public parking lots, bicycle lockers, or carshare facilities.	System-wide transportation facilities including streets, sidewalks, bike lanes, trails, and transit
Tax Increment Financing (TIF)	A tool cities use to create special districts (tax increment areas) where public improvements are made in order to generate private-sector development. During a defined period, the tax base is frozen at the pre-development	System-wide transportation facilities including streets, sidewalks, bike lanes,

Funding Source	Description	Potential Application in Prineville
	level. Property taxes for that period can be waived or paid, but taxes derived from increases in assessed values (the tax increment) resulting from new development can go into a special fund created to retire bonds issued to originate the development or leverage future improvements. A number of small-to-medium sized communities in Oregon have implemented, or are considering implementing, urban renewal districts that will result in a TIF revenue stream.	trails, and transit
Local Improvement Districts (LID)	A local improvement district is a geographic area where local property owners are assessed a fee to cover the cost of a public improvement in that area.	Improvements to the transportation system in a local area where local property owners will benefit from the improvement.

State and Federal Grants

In addition to local funding sources, the City of Prineville can seek to leverage opportunities for funding from grants at the State and Federal levels for specific projects. The current Federal transportation bill, MAP-21, expires in September 2014, and funding opportunities may change after that date. Table 6-5 outlines those sources and their potential applications.

Table 6-5 Potential State and Federal Grants

Funding Source	Description	Potential Application in Prineville
Statewide Transportation Improvement Program (STIP)	<p>STIP is the State of Oregon’s four-year transportation capital improvement program. Local agencies apply in advance for projects to be funded in each four-year cycle.</p> <p>Capital projects are prioritized based on benefit categories, including (in the 2015-2018 STIP) benefits to state-owned facilities, mobility, accessibility, economic vitality, environmental stewardship, land use and growth management, livability, safety and security, equity, and funding and finance.</p>	Projects on any facility that meet the benefit categories of the STIP.
Transportation and Growth Management Grants (TGM)	<p>TGM Grants are administered by ODOT and awarded on an annual basis. The TGM grants are generally awarded to projects that will lead to more livable, economically vital, transportation efficient, sustainable, pedestrian-friendly communities. The grants are awarded in two categories: transportation system planning and integrated land use & transportation planning.</p>	Multi-use trails, sidewalk, and bicycle facilities.
Transportation Alternatives Program (TAP)	<p>TAP is a federal program that provides funding for pedestrian and bicycle facilities, projects for improving public transit access, safe routes to schools, and recreational trails. Local governments, regional transportation authorities, transit agencies, school districts or schools, natural resource or public land agencies, and tribal governments are all eligible to receive TAP funds.</p>	Bicycle and pedestrian facilities, multi-use trails.
Highway Safety Improvement Program (HSIP)	<p>HSIP is a federal program that provides funding to infrastructure and non-infrastructure projects that improve safety on all public roads. HSIP requires a data-driven approach and prioritizes projects in demonstrated problem areas.</p>	Areas of safety concerns within the city, consistent with Oregon’s Transportation Safety Action Plan.
Congestion Mitigation and Air Quality (CMAQ)	<p>CMAQ is a federal program, administered through the state, and funds projects that help reduce emissions and meet national air quality standards, such as transportation demand management programs, bicycle and pedestrian improvements, transit projects, diesel retrofits, and vehicle emissions reductions programs.</p>	Projects that demonstrate the potential to reduce emissions: bicycle and pedestrian facilities, transportation demand management.

APPENDICES:

Appendix A: Travel Demand Model Process

Appendix B: Model Requests for Alternatives

Appendix C: Model Output for Alternatives

Appendix D: TAC/PAC Meeting Handouts and Comments

Appendix E: Intersection Performance Technical Output for Parallel Routes Alternative

Appendix F: Concept of Channelization for O'Neil Highway/OR 126

Appendix A Travel Demand
 Model Process

TRAVEL DEMAND MODEL PROCESS

Within the travel demand model, the City is divided into a series of subareas (Transportation Analysis Zones, or TAZs) based on their zoning, parcel boundaries, or other natural or man-made barriers (creeks, railways, or topographic areas). Each of these subareas contains information related to the number of employees (by market sector) and the population (households). This information, which is based on payroll data and census information, is calibrated to the existing traffic counts to ensure that the model accurately reflects the current travel patterns within the City.

Once the base year travel demand models are calibrated, additional information within each of the subareas is provided for the year 2035. This includes population forecasts for the City that are coordinated from the State to Crook County, and then assigned to Prineville. Through 2035, the City anticipates population growth of nearly 1,650 households (approximately 4,000 more people).

The expected growth in population is manually assigned to the subareas by City staff. Generally, growth is assumed to occur on properties that are already entitled or have active planning applications (e.g., Iron Horse, Anglers Canyon, etc.), readily buildable lands, and is conducted with consideration of the existing zoning. This population assignment also considers the allowable densities within the zoning, and leverages other Comprehensive Plan elements such as the City's *Buildable Lands Inventory* and *Housing* elements.

Employment growth in the City is not coordinated through the State, and is generally assumed to maintain current workforce to population ratios. Within Prineville key employment areas include designated portions of Iron Horse, the Ochoco Lumber site, designated industrial property near Main Street – McKay and Peters Road, industrial properties surrounding the airport, and areas along Lamonta Road. In total, approximately 1,750 new jobs are expected in Prineville by 2035.

Appendix B Model Requests for
Alternatives

REQUEST FOR TRAVEL DEMAND MODEL RUN

BACKGROUND

Travel demand models are used for transportation project development, transportation planning and land use planning. Models are adapted to represent the project/development characteristics and report on the areas affected by the project. Project data is used to update transportation networks and related land use changes. From the time all appropriate data have been received, a typical modeling request takes two to three weeks to complete. The time leading up to the actual model run can take nearly as much time. Therefore, using this request form as a guide to making a request for a model run should greatly reduce the time required to assemble the information needed to start the model run. Requesting agencies should be prepared to discuss details related to their model run request. This may take place as a phone call or a meeting, depending on the complexity of the request.

ISSUES

1. Multiple agencies rely on TPAU for model runs, so there will inevitably be scheduling conflicts. Multiple requests received very close to each other will delay the turnaround time for some projects. When workload is high, requests are prioritized and completed in as timely a manner as possible.
2. Before the model run preparation can begin, detailed and complete information is needed from the requesting agency/firm. This form is designed to collect the following:
 - The project opening year and design year;
 - The project impact area to be included in model run outputs;
 - Socioeconomic changes (employment changes, housing developments, new retail development, etc.) in the project area to be included in model runs;
 - Detailed descriptions of project alternatives to be tested; and
 - A list of other projects to be included in the networks with the project being analyzed.

Please submit requests to:

Brian Dunn
Transportation Planning Analysis Unit
555 13th St. NE, Suite 2
Salem, OR 97301
503.986.4103
Brian.G.Dunn@odot.state.or.us

Submittal of a request using this form is the first step. An agency contact person will follow-up this request with a phone call or meeting as necessary to obtain further detail. This request form serves as the formal documentation for a model run and will be filed as public record. All model parameters changed for a run must be documented and described in detail.

To: Brian Dunn

Cc: <MPO>, <ODOT Region Contact>

Requesting Agency or Firm: Kittelson & Associates, Inc.

Date of Request: 1/16/2013

Contact Person: Joe Bessman

Address: 354 SW Upper Terrace Dr, Suite 100

Email: jbessman@kittelson.com

Phone number: (541) 312-8300

ODOT Requests: EA to charge _____

Outside ODOT Requests: Please provide billing information if different from above contact information.

TGM 4A-11/Prineville Transportation System Plan

Name of Model: Prineville Travel Demand Model

Year(s) Requesting Model Output: 2035 _____

Provide the name and a brief description of the Project using output from the travel demand model:

TGM 4A-11/Prineville Transportation System Plan

Provide a brief description of purpose, goals and objectives of the model run. Briefly describe how model results will be used. What questions do you seek to answer using this information?

Purpose of the model runs is to consider three new scenarios that assess varying levels of capacity increases along 3rd Street (US 26) and Main Street. The intent is to understand the impact of these changes on the levels of rerouting to the adjacent local street system.

Requestor should become familiar with the model used for analysis. Familiarity should include areas such as model base year, future year, zone structure, network structure and attributes. ODOT will

provide a GIS layer or PDF with the TAZ structure, link structure and attributes. All model settings requested must be specified in terms of the model. Street names, addresses and physical landmarks are not sufficient to identify location of changes.

Requestor must provide a complete and detailed description of the changes to be made for the model run, including changes to the network (capacity, speed, new lanes, new or deleted links, etc.) and land use data (employment, population). Changes to land use must include a narrative detailing supportive assumptions associated with such changes.

Note that travel models provide only generalized travel forecasts because they are based on generalized land use patterns and transportation networks. Since models do not represent individual land uses, driveways or neighborhood-scale streets, the forecasts produced are not sensitive to these specific land use and transportation characteristics.

It is inappropriate to use raw model outputs as the basis for transportation and land use decisions that require consideration of detailed transportation and land use characteristics. Therefore, post-processing of model outputs to account for the influence of specific transportation and land use characteristics is mandatory. Methods used for post-processing must conform to specifications provided within the ODOT Analysis Procedures Manual (http://www.oregon.gov/ODOT/TD/TP/TAPM.shtml#Analysis_Procedures_Manual).

Changes to Network

Changes to Existing Network Attributes

1. Provide brief description of actual change on the street being modeled and the expected effect of such a change.
2. Identify the network links to be changed using “From Node - To Node” or link ID. Specify what attribute(s) is to be changed and what the change is.
3. Provide a map illustrating location and reference to description of changes.

Note: If a large number of network changes or several model runs are being requested, submit information using a spreadsheet listing out individual projects. A map illustrating the requested network changes should also be provided for each run separately. Note that separate networks exist for roads, transit and walk.

Model Changes to be Made: Network Attributes

Project w/ brief description	Network Action: - change link attribute - new link (include map)	Link ID (Fnode-Tnode)	Change Attribute: - speed - lanes - FC - Signal - Other?	Project Number (1, 2, 3)
Peters Road Extension	New Link (Peters Road connect to Iron Horse TAZ)	Unknown	35 mph design speed	1

Projects Included in Scenario

Scenario Number	Projects Included	Notes:
1	1	
2	1	
3	1	

Additions/Deletions to Existing Network

1. Provide brief description of actual change on the street being modeled.
2. Identify the addition/deletion to be made to network. Include attributes of new links and nodes.
3. Provide a map illustrating the location and nature of changes to be made. Clearly identify where new links are connected to original network.
4. Review nearby connectors and how they relate to the altered network. Identify necessary changes to connectors.

Note: If a large number of network changes or several model runs are being requested, submit information using a spreadsheet listing out individual projects. Separate maps illustrating the requested network changes should be provided for each scenario separately. Note that separate networks exist for road, transit and walk.

Model Changes to be Made: Network Attributes

Project w/ brief description	Network Action: - delete link - add new link - change connector	Network Attributes: - speed - lanes - FC - Signal?	Project Number (1, 2, 3)
None (other than Peters as described above)			

Projects Included in Scenario

Scenario Number	Projects Included	Notes:
1	10% Capacity Increase on 3 rd Street (US 26) between the “Y” and Combs Flat; 10% Capacity Increase on Main Street between 3 rd Street and Peters Road	
2	20% Capacity Increase on 3 rd Street (US 26) between the “Y” and Combs Flat; 20% Capacity Increase on Main Street between 3 rd Street and Peters Road	
3	30% Capacity Increase on 3 rd Street (US 26) between the “Y” and Combs Flat; 30% Capacity Increase on Main Street between 3 rd Street and Peters Road	

Changes to Transportation Analysis Zone Land Use Data

Land use data refers to population and employment data. Future population must conform to official state forecasts prepared by the Office of Economic Analysis, DAS for analysis conducted for planning purposes. Note that industry categories vary by model and employment must be associated with the appropriate industry.

TAZ (provide TAZ number or map of location):

Population: *

Increase/decrease population by: No Changes

Increase/decrease households by:

Employment: *

Increase/decrease employment by:

For industry category:

Will these changes require any TAZs to be split to accurately represent travel patterns?

Yes No

If so, please identify which TAZ(s) by number and supply a map illustrating desired change.

Will these changes require relocation of centroid connectors?

Yes No

If so, please identify which TAZ(s) centroid connector by number and provide a map illustrating desired change.

**Employment and population must be balanced within the model area. This means trip attractions are balanced to trip production for home-based trip purposes. When evaluating effects of large changes to employment, assumptions regarding the location of households providing workers and expected decreases in employment in other TAZs should be clearly specified. When evaluating effects of large changes to population, assumptions regarding the location of jobs should be clearly identified.*

.....
Other changes to be made for model run:

Output Requested from Model Run Request:

Menu of Standard ODOT Travel Demand Model Outputs					
Select Output Format					
Shape File*	Model Network**	PDF file	Time of Day	<input checked="" type="checkbox"/> Peak Hour	<input type="checkbox"/> Daily
<input checked="" type="checkbox"/>	<input type="checkbox"/>	<input type="checkbox"/>	Link Volume– link text only		
NA	<input type="checkbox"/>	<input type="checkbox"/>	Link Volume– bandwidths with link text		
<input type="checkbox"/>	<input type="checkbox"/>	<input type="checkbox"/>	Select Link Volume		
<input type="checkbox"/>	<input type="checkbox"/>	<input type="checkbox"/>	Select Zone Volume		
<input type="checkbox"/>	<input type="checkbox"/>	<input type="checkbox"/>	Demand to Capacity Ratio		
<input type="checkbox"/>	<input type="checkbox"/>	<input type="checkbox"/>	Absolute Volume Difference– link text only		
<input checked="" type="checkbox"/>	<input type="checkbox"/>	<input checked="" type="checkbox"/>	Relative Volume Difference - link text only		
NA	<input type="checkbox"/>	<input type="checkbox"/>	Absolute Volume Difference– bandwidths with link text		
NA	<input type="checkbox"/>	<input type="checkbox"/>	Relative Volume Difference– bandwidths with link text		
<input type="checkbox"/>	<input type="checkbox"/>	<input type="checkbox"/>	Other:		
<input type="checkbox"/>	<input type="checkbox"/>	<input type="checkbox"/>	Other:		
* VISUM model only					
** EMME2 or VISUM					

NOTE: Relative scenario requested to be the difference from the base year model (2010); this would be the 2035 – 2010 results.

Definitions:

- Link Volume – The peak hour (or daily if requested) traffic using each link (street) for a requested area or for the entire model network.
- Select Link or Zone Volume (also called “flow bundles” by ptv-VISUM) – Represents the traffic using a given link or zone or group of links or zones. They graphically represent the origins and destinations of select links and/or zones and display all of the travel patterns associated with the selected locations. These are typically used to apply trip rates (like ITE trip generation) to the network, or to better understand an area and the users.
- Demand to Capacity Ratio – This is a ratio of the model volume (usually hourly volume, although daily can be requested) to the model capacity. In the future years the volume on a given link may be greater than the volume that could pass through that point in an hour, due to great congestion on the network and the principles behind travel demand models. For this reason the word demand is used not volume, as the model volume might be greater than the actual volume (by definition the volume to capacity ratio must never be greater than 1). The capacity is the model capacity, which represents a mid street capacity. Facility type and speed go into determining this capacity. Note that the model capacity is not a saturation flow; the model capacity needs to account for the capacity reductions due to intersections. The measure of demand to capacity is – model volume / model capacity – given for a requested area.

- Volume Difference, Absolute & Relative – Absolute Volume difference is the subtraction of the volume that results from the model run requested versus a reference (or base) run, usually the financially constrained future year run, but it can be any reference case desired by the requestor. Relative volume would be the percentage change from the requested run and the reference run specified by the requestor.
- O & D Matrix – The full Origin – Destination Matrix that the model uses to assign trips to the network can be requested. TPAU will also help with Aggregated O & D Matrices to the district level, which can be plotted graphically along with select links or zones. If desired, TPAU will work with the requestor to help answer traffic flow questions that require O & D matrices or District-to-District plotting.
- Bandwidths – The link volume can be represented graphically with a bar whose thickness is directly related to the volume of the link, meaning that the larger the volume the thicker the bar.

Internal Use Only – TPAU Model Run Documentation and Organization Info

Model Name: _____ Project Name: _____ Model Run(s) Number: _____

Date Reviewed by MPO: _____ Date Received by TPAU: _____

Date Accepted by TPAU as Final/Complete Request: _____

Date Request Completed: _____

TPAU Analyst(s): _____ MPO/Region Cc'd? _____

Travel Demand Model Request

The purpose of this memorandum is to describe the scenarios needed for the City of Prineville future alternatives analysis. All of these scenarios should be based on the 30% capacity increase scenario used as part of the 2035 no-build analysis.

Scenario 1: Connectivity Options. This scenario will consider connections to the north and south portions of Prineville with no changes to US 26/3rd Street. The desired connections are shown in the figure below. All new connections should be modeled as two-lane collectors, with a 35 mph design speed.

Scenario 2: The second scenario will assess a five-lane cross-section on US 26/3rd Street. Manual post-processing of this travel demand model run will be used to analyze a series of options including couplets, the five-lane section, and development of parallel routes.

Scenario 3: The third scenario will assess a connection commonly referred to as “Brummer Road.” This connection would be located outside of City limits, connecting OR 126 to Main Street approximately five miles south of Lynn Boulevard. This connection has been considered as part of the County TSP as an emergency access route, though I could find no specific reference to this connection, only a Davis Road connection that links Juniper Canyon with the Crooked River Highway (see attached PDF).

For modeling purposes this connection should assume a 35 mph design speed as it connects Juniper Canyon to Main Street, and a 35 mph average speed as it connects further west to Millican Road.

Other Model Information: We would also like to request a select link analysis along Third Street immediately east and west of Main Street. We think this will help inform what connection options provide the most value to the City.

REQUEST FOR TRAVEL DEMAND MODEL RUN

BACKGROUND

Travel demand models are used for transportation project development, transportation planning and land use planning. Models are adapted to represent the project/development characteristics and report on the areas affected by the project. Project data is used to update transportation networks and related land use changes. From the time all appropriate data have been received, a typical modeling request takes two to three weeks to complete. The time leading up to the actual model run can take nearly as much time. Therefore, using this request form as a guide to making a request for a model run should greatly reduce the time required to assemble the information needed to start the model run. Requesting agencies should be prepared to discuss details related to their model run request. This may take place as a phone call or a meeting, depending on the complexity of the request.

ISSUES

1. Multiple agencies rely on TPAU for model runs, so there will inevitably be scheduling conflicts. Multiple requests received very close to each other will delay the turnaround time for some projects. When workload is high, requests are prioritized and completed in as timely a manner as possible.
2. Before the model run preparation can begin, detailed and complete information is needed from the requesting agency/firm. This form is designed to collect the following:
 - The project opening year and design year;
 - The project impact area to be included in model run outputs;
 - Socioeconomic changes (employment changes, housing developments, new retail development, etc.) in the project area to be included in model runs;
 - Detailed descriptions of project alternatives to be tested; and
 - A list of other projects to be included in the networks with the project being analyzed.

Please submit requests to:

Brian Dunn
Transportation Planning Analysis Unit
555 13th St. NE, Suite 2
Salem, OR 97301
503.986.4103
Brian.G.Dunn@odot.state.or.us

Submittal of a request using this form is the first step. An agency contact person will follow-up this request with a phone call or meeting as necessary to obtain further detail. This request form serves as the formal documentation for a model run and will be filed as public record. All model parameters changed for a run must be documented and described in detail.

To: Brian Dunn

Cc: <MPO>, <ODOT Region Contact>

Requesting Agency or Firm: Kittelson & Associates, Inc.

Date of Request: 1/16/2013

Contact Person: Joe Bessman

Address: 354 SW Upper Terrace Dr, Suite 100

Email: jbessman@kittelson.com

Phone number: (541) 312-8300

ODOT Requests: EA to charge _____

Outside ODOT Requests: Please provide billing information if different from above contact information.

TGM 4A-11/Prineville Transportation System Plan

Name of Model: Prineville Travel Demand Model

Year(s) Requesting Model Output: 2035 _____

Provide the name and a brief description of the Project using output from the travel demand model:

TGM 4A-11/Prineville Transportation System Plan

Provide a brief description of purpose, goals and objectives of the model run. Briefly describe how model results will be used. What questions do you seek to answer using this information?

See attached- purpose is to inform the development of system alternatives.

Requestor should become familiar with the model used for analysis. Familiarity should include areas such as model base year, future year, zone structure, network structure and attributes. ODOT will provide a GIS layer or PDF with the TAZ structure, link structure and attributes. All model settings requested must be specified in terms of the model. Street names, addresses and physical landmarks are not sufficient to identify location of changes.

Requestor must provide a complete and detailed description of the changes to be made for the model run, including changes to the network (capacity, speed, new lanes, new or deleted links, etc.) and land use data (employment, population). Changes to land use must include a narrative detailing supportive assumptions associated with such changes.

Note that travel models provide only generalized travel forecasts because they are based on generalized land use patterns and transportation networks. Since models do not represent individual land uses, driveways or neighborhood-scale streets, the forecasts produced are not sensitive to these specific land use and transportation characteristics.

It is inappropriate to use raw model outputs as the basis for transportation and land use decisions that require consideration of detailed transportation and land use characteristics. Therefore, post-processing of model outputs to account for the influence of specific transportation and land use characteristics is mandatory. Methods used for post-processing must conform to specifications provided within the ODOT Analysis Procedures Manual (http://www.oregon.gov/ODOT/TD/TP/TAPM.shtml#Analysis_Procedures_Manual).

Changes to Network

Changes to Existing Network Attributes

1. Provide brief description of actual change on the street being modeled and the expected effect of such a change.
2. Identify the network links to be changed using “From Node - To Node” or link ID. Specify what attribute(s) is to be changed and what the change is.
3. Provide a map illustrating location and reference to description of changes.

Note: If a large number of network changes or several model runs are being requested, submit information using a spreadsheet listing out individual projects. A map illustrating the requested network changes should also be provided for each run separately. Note that separate networks exist for roads, transit and walk.

Model Changes to be Made: Network Attributes

Project w/ brief description	Network Action: - change link attribute - new link (include map)	Link ID (Fnode-Tnode)	Change Attribute: - speed - lanes - FC - Signal - Other?	Project Number (1, 2, 3)
See attached – Davis Road connection from Juniper Canyon to Crooked River Hwy, connection further west to Millican Road	New link	Unknown	35 mph, 2 lanes, collector, no traffic control (stop signs)	1
Rimrock Rd to Main Street	New link	Unknown	35 mph, 2 lanes, collector, stop signs only	2
US 26 to Main Street/Peters Road north connection	New link	Unknown	35 mph, 2 lanes, collector, stop signs only	3
Combs Flat to Peters Road Extension	New link	Unknown	35 mph, 2 lanes, collector, stop signs only	4

Additions/Deletions to Existing Network

1. Provide brief description of actual change on the street being modeled.

2. Identify the addition/deletion to be made to network. Include attributes of new links and nodes.
3. Provide a map illustrating the location and nature of changes to be made. Clearly identify where new links are connected to original network.
4. Review nearby connectors and how they relate to the altered network. Identify necessary changes to connectors.

Note: If a large number of network changes or several model runs are being requested, submit information using a spreadsheet listing out individual projects. Separate maps illustrating the requested network changes should be provided for each scenario separately. Note that separate networks exist for road, transit and walk.

Model Changes to be Made: Network Attributes

Project w/ brief description	Network Action: - delete link - add new link - change connector	Network Attributes: - speed - lanes - FC - Signal?	Project Number (1, 2, 3)
As described above and shown on attachment			

Projects Included in Scenario

Scenario Number	Projects Included	Notes:
3	30% Capacity Increase on 3 rd Street (US 26) between the “Y” and Combs Flat; 30% Capacity Increase on Main Street between 3 rd Street and Peters Road	

Changes to Transportation Analysis Zone Land Use Data

Land use data refers to population and employment data. Future population must conform to official state forecasts prepared by the Office of Economic Analysis, DAS for analysis conducted for planning purposes. Note that industry categories vary by model and employment must be associated with the appropriate industry.

TAZ (provide TAZ number or map of location):

Population:*

Increase/decrease population by: No Changes

Increase/decrease households by:

Employment:*

Increase/decrease employment by:

For industry category:

Will these changes require any TAZs to be split to accurately represent travel patterns?

Yes No

If so, please identify which TAZ(s) by number and supply a map illustrating desired change.

Will these changes require relocation of centroid connectors?

Yes No

If so, please identify which TAZ(s) centroid connector by number and provide a map illustrating desired change.

**Employment and population must be balanced within the model area. This means trip attractions are balanced to trip production for home-based trip purposes. When evaluating effects of large changes to employment, assumptions regarding the location of households providing workers and expected decreases in employment in other TAZs should be clearly specified. When evaluating effects of large changes to population, assumptions regarding the location of jobs should be clearly identified.*



Other changes to be made for model run:

Output Requested from Model Run Request:

Menu of Standard ODOT Travel Demand Model Outputs					
Select Output Format					
Shape File*	Model Network**	PDF file	Time of Day	<input checked="" type="checkbox"/> Peak Hour	<input type="checkbox"/> Daily
<input checked="" type="checkbox"/>	<input type="checkbox"/>	<input type="checkbox"/>	Link Volume– link text only		
NA	<input type="checkbox"/>	<input type="checkbox"/>	Link Volume– bandwidths with link text		
<input type="checkbox"/>	<input type="checkbox"/>	<input checked="" type="checkbox"/>	Select Link Volume (For 3 rd Street Select Link Analyses Only)		
<input type="checkbox"/>	<input type="checkbox"/>	<input type="checkbox"/>	Select Zone Volume		
<input type="checkbox"/>	<input type="checkbox"/>	<input type="checkbox"/>	Demand to Capacity Ratio		
<input type="checkbox"/>	<input type="checkbox"/>	<input type="checkbox"/>	Absolute Volume Difference– link text only		
<input type="checkbox"/>	<input type="checkbox"/>	<input type="checkbox"/>	Relative Volume Difference - link text only		
NA	<input type="checkbox"/>	<input type="checkbox"/>	Absolute Volume Difference– bandwidths with link text		
NA	<input type="checkbox"/>	<input type="checkbox"/>	Relative Volume Difference– bandwidths with link text		
<input type="checkbox"/>	<input type="checkbox"/>	<input type="checkbox"/>	Other:		
<input type="checkbox"/>	<input type="checkbox"/>	<input type="checkbox"/>	Other:		
* VISUM model only					
** EMME2 or VISUM					

NOTE: Relative scenario requested to be the difference from the base year model (2010); this would be the 2035 – 2010 results.

Definitions:

- Link Volume – The peak hour (or daily if requested) traffic using each link (street) for a requested area or for the entire model network.
- Select Link or Zone Volume (also called “flow bundles” by ptv-VISUM) – Represents the traffic using a given link or zone or group of links or zones. They graphically represent the origins and destinations of select links and/or zones and display all of the travel patterns associated with the selected locations. These are typically used to apply trip rates (like ITE trip generation) to the network, or to better understand an area and the users.
- Demand to Capacity Ratio – This is a ratio of the model volume (usually hourly volume, although daily can be requested) to the model capacity. In the future years the volume on a given link may be greater than the volume that could pass through that point in an hour, due to great congestion on the network and the principles behind travel demand models. For this reason the word demand is used not volume, as the model volume might be greater than the actual volume (by definition the volume to capacity ratio must never be greater than 1). The capacity is the model capacity, which represents a mid street capacity. Facility type and speed go into determining this capacity. Note that the model capacity is not a saturation flow; the model capacity needs to account for the capacity reductions due to intersections. The measure of demand to capacity is – model volume / model capacity – given for a requested area.

- Volume Difference, Absolute & Relative – Absolute Volume difference is the subtraction of the volume that results from the model run requested verses a reference (or base) run, usually the finically constrained future year run, but it can be any reference case desired by the requestor. Relative volume would be the percentage change from the requested run and the reference run specified by the requestor.
- O & D Matrix – The full Origin – Destination Matrix that the model uses to assign trips to the network can be requested. TPAU will also help with Aggregated O & D Matrices to the district level, which can be plotted graphically along with select links or zones. If desired, TPAU will work with the requestor to help answer traffic flow questions that require O & D matrices or District-to-District plotting.
- Bandwidths – The link volume can be represented graphically with a bar whose thickness is directly related to the volume of the link, meaning that the larger the volume the thicker the bar.

Internal Use Only – TPAU Model Run Documentation and Organization Info

Model Name: _____ Project Name: _____ Model Run(s) Number: _____

Date Reviewed by MPO: _____ Date Received by TPAU: _____

Date Accepted by TPAU as Final/Complete Request: _____

Date Request Completed: _____

TPAU Analyst(s): _____ MPO/Region Cc'd? _____



JUNIPER CANYON ACCESS RD

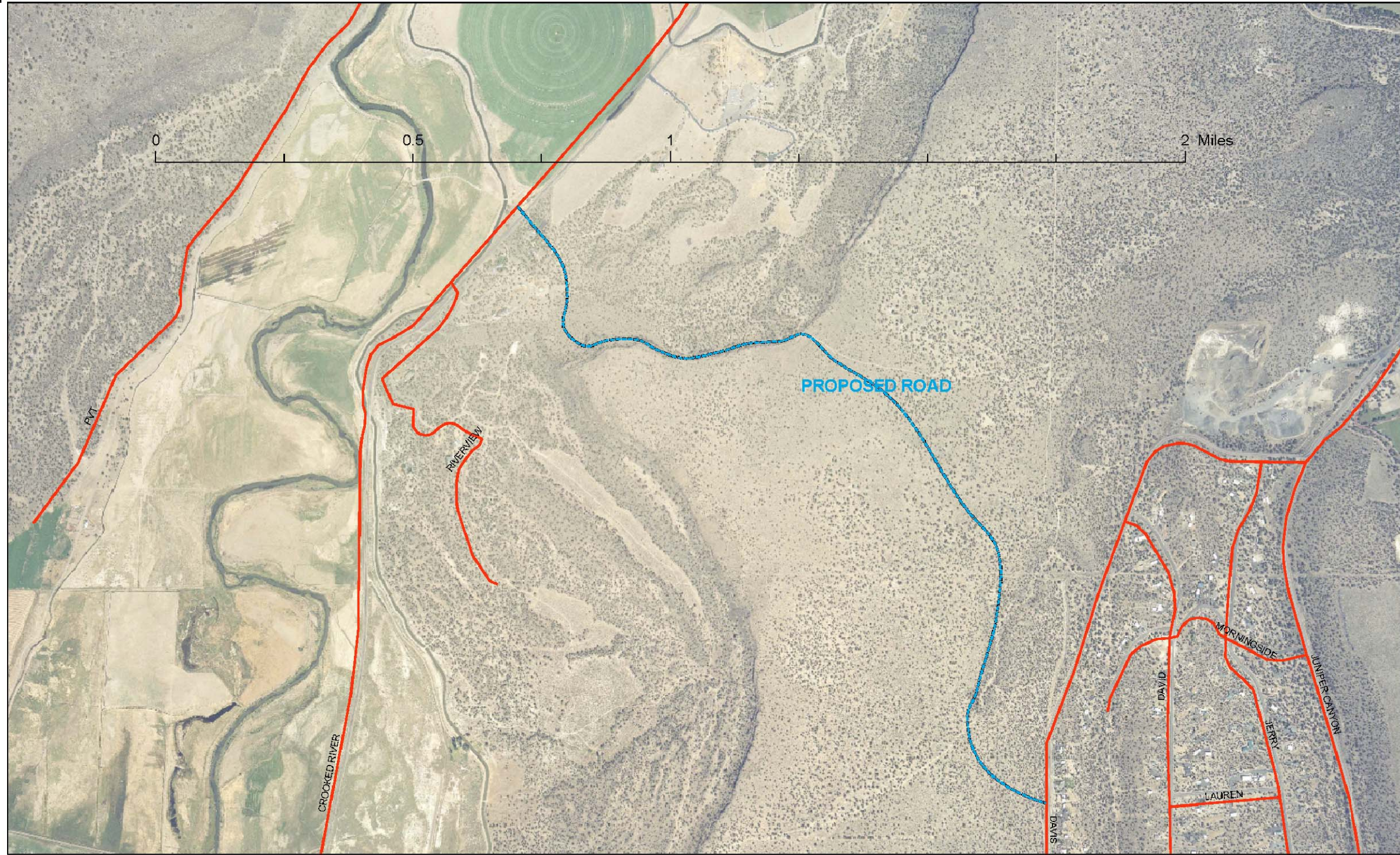

Crook County Transportation System Plan



NOT TO SCALE

Figure 6-4
Alternative 2

Davis Road to OR 27 Connection

Appendix C Model Output for
Alternatives

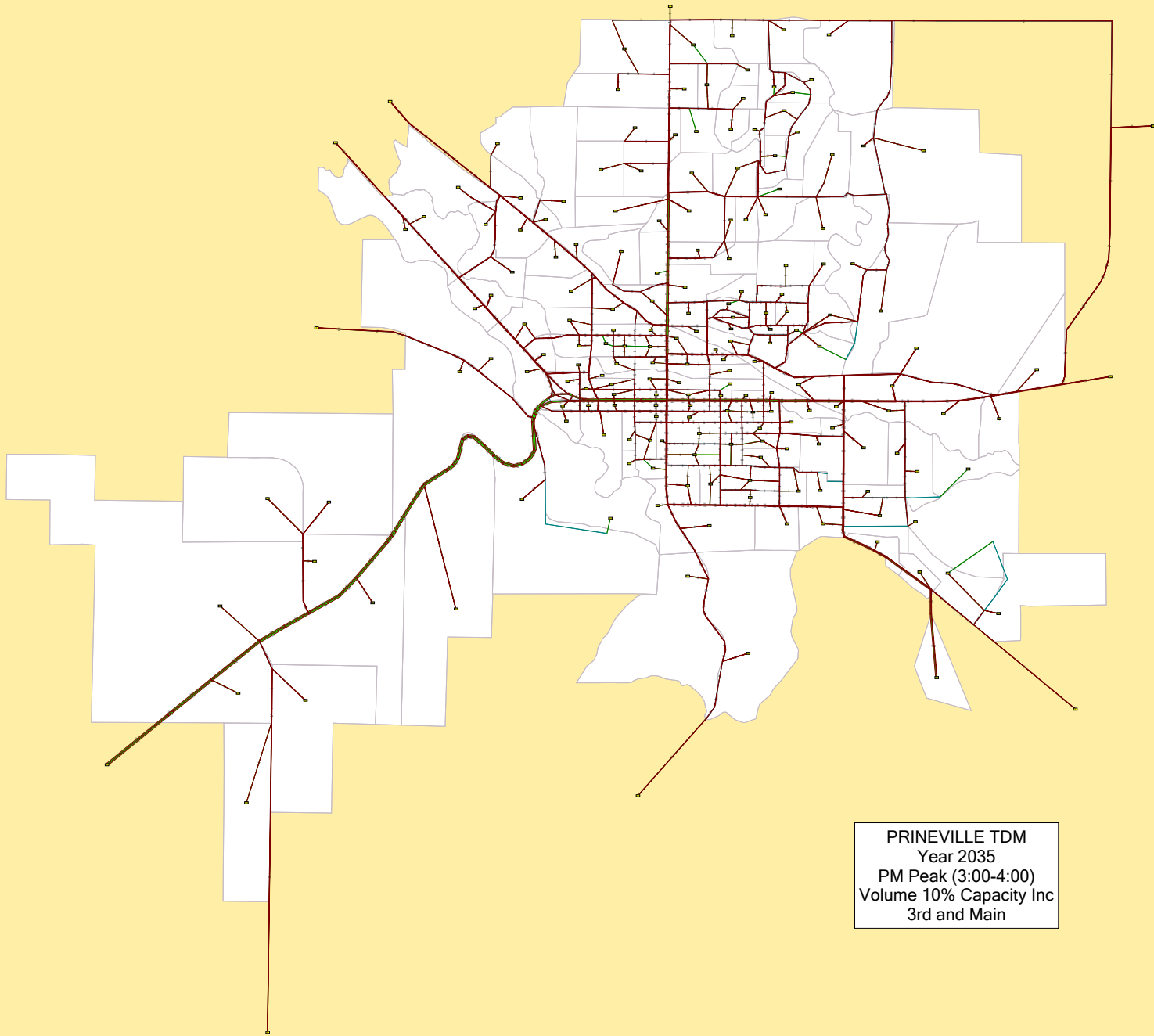

PRINEVILLE TDM
Year 2035
PM Peak (3:00-4:00)
Volume 10% Capacity Inc
3rd and Main

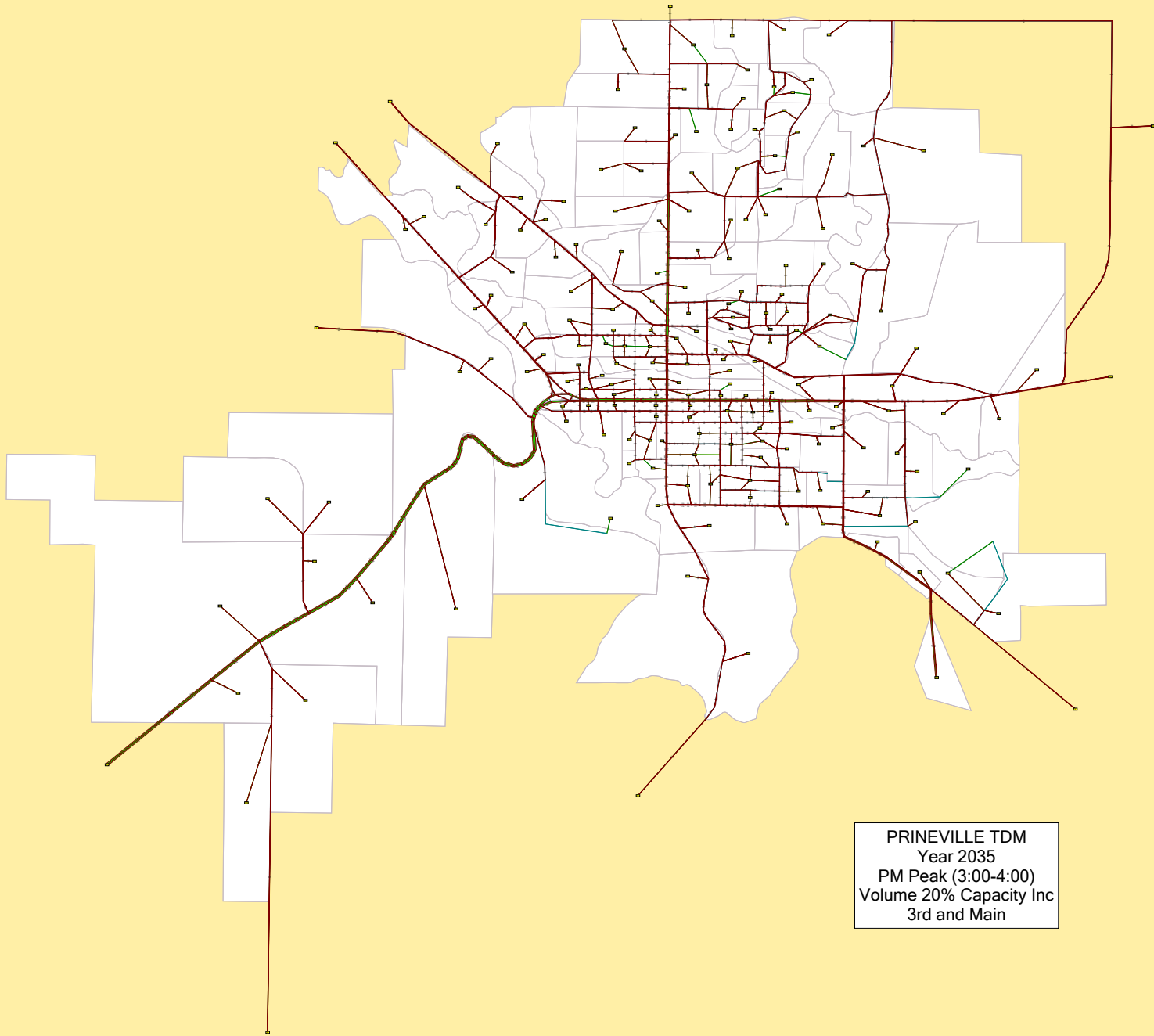

PRINEVILLE TDM
Year 2035
PM Peak (3:00-4:00)
Volume 20% Capacity Inc
3rd and Main

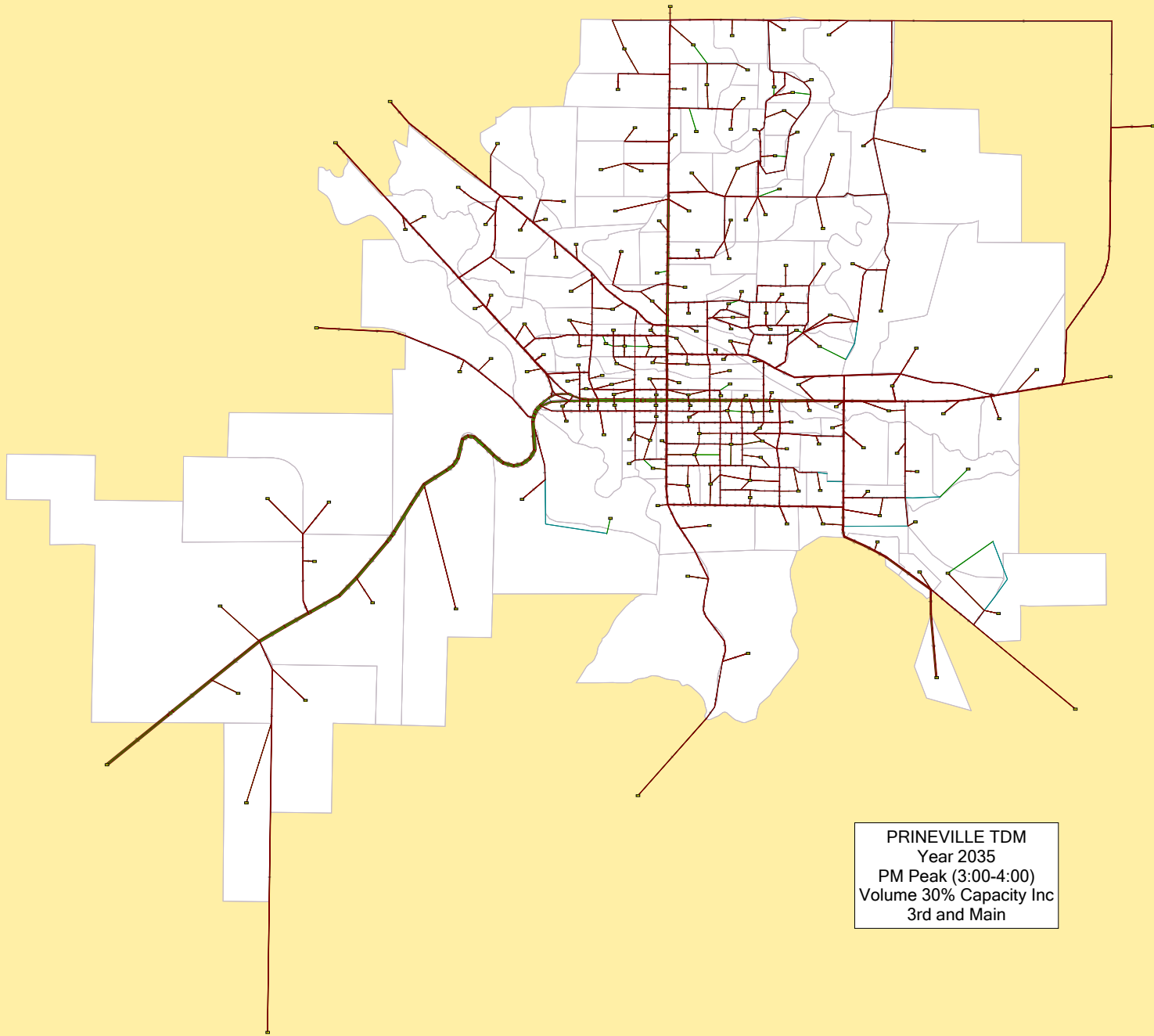

PRINEVILLE TDM
Year 2035
PM Peak (3:00-4:00)
Volume 30% Capacity Inc
3rd and Main

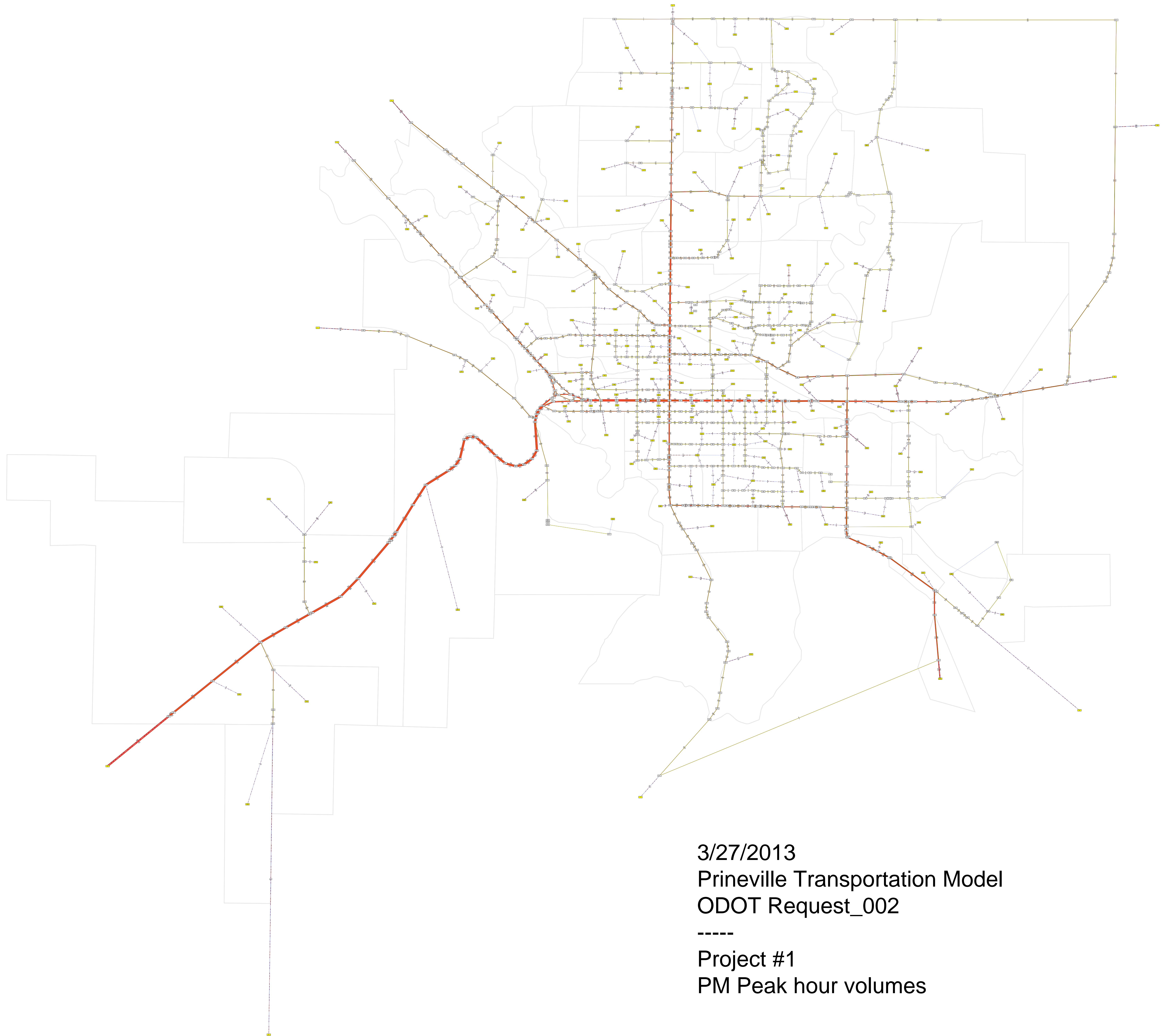

3/27/2013
Prineville Transportation Model
ODOT Request_002

Project #1
PM Peak hour volumes

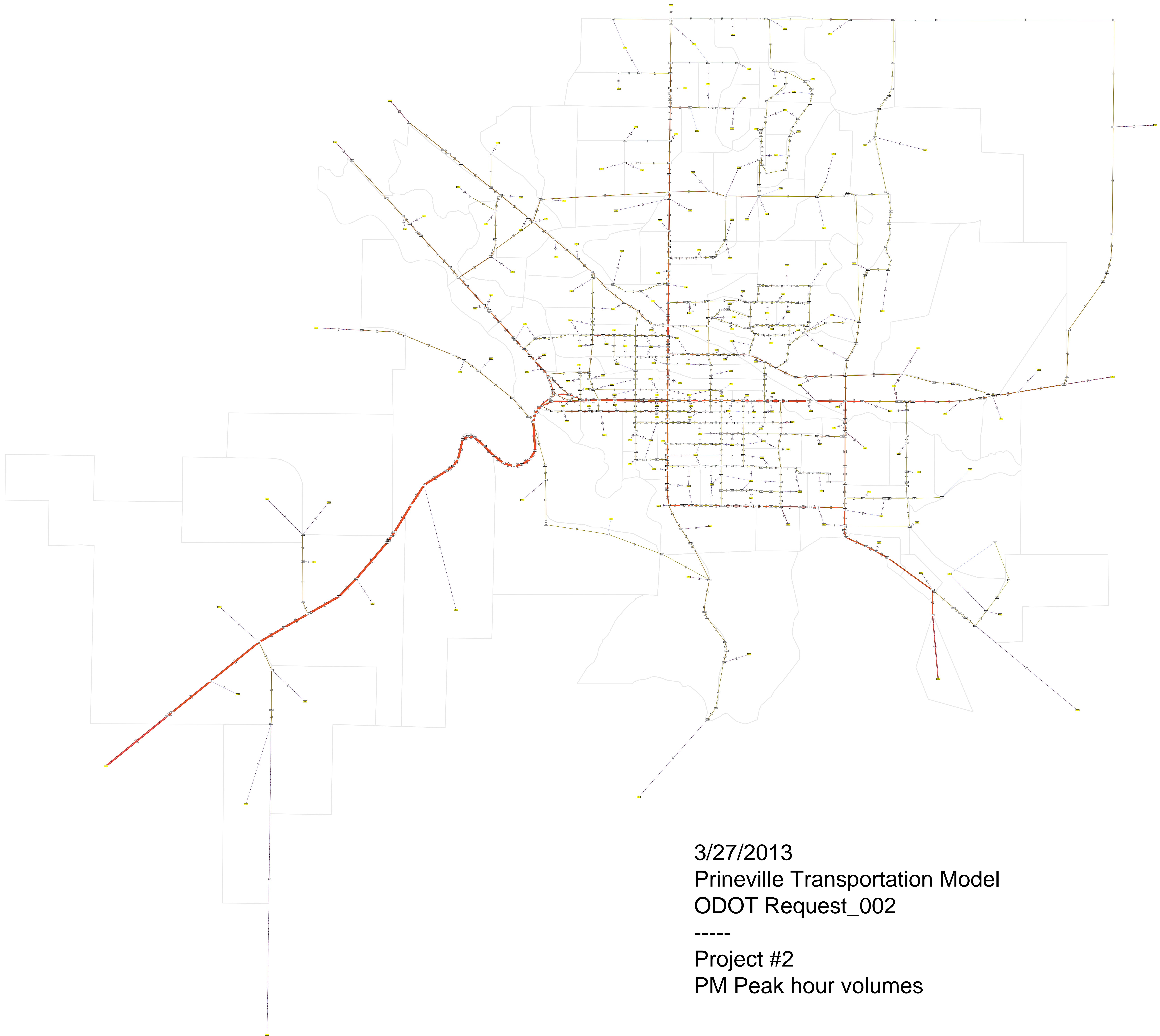

3/27/2013
Prineville Transportation Model
ODOT Request_002

Project #2
PM Peak hour volumes

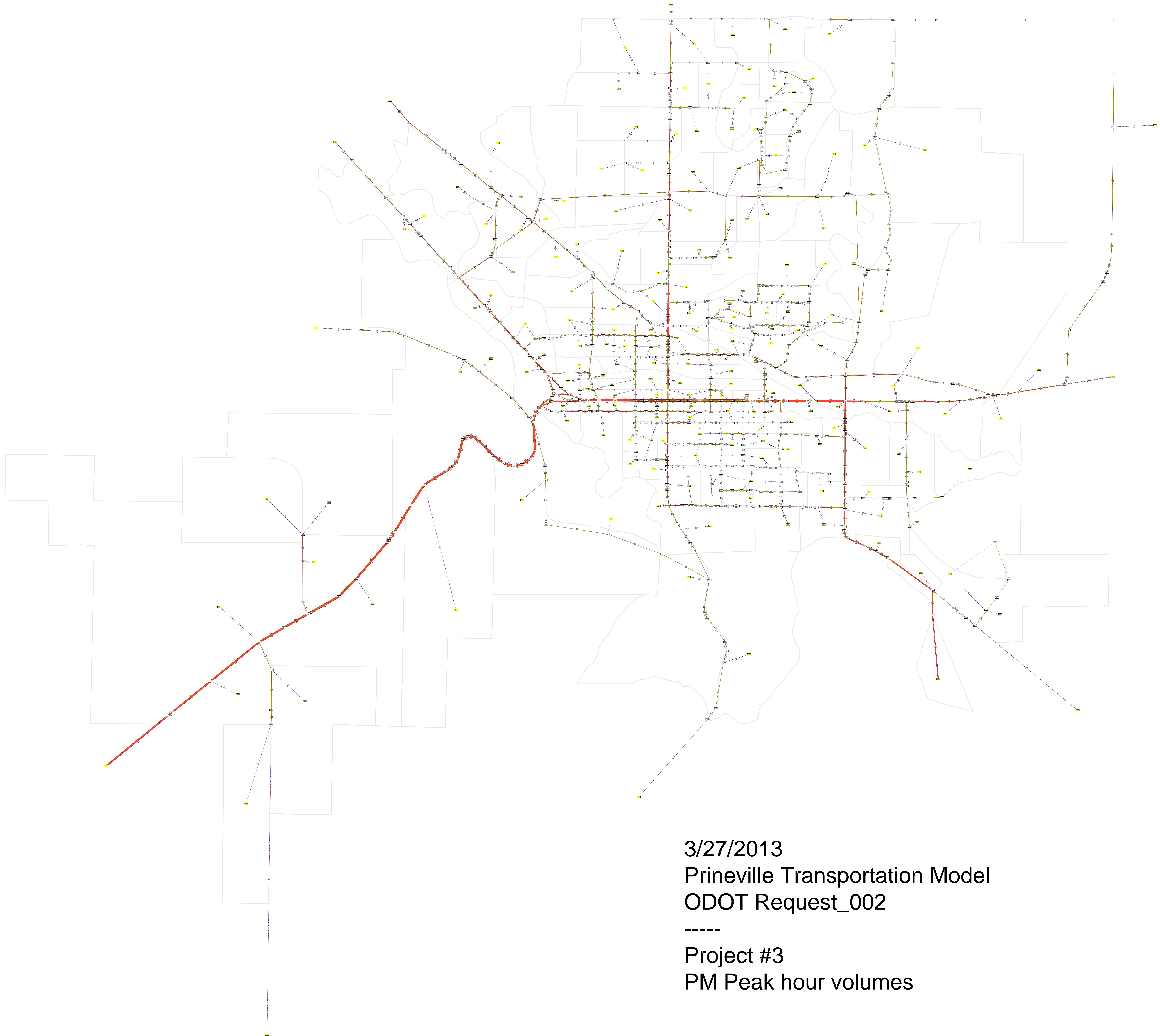

3/27/2013
Prineville Transportation Model
ODOT Request_002

Project #3
PM Peak hour volumes

Appendix D TAC/PAC Meeting
Handouts and
Comments



CITY OF PRINEVILLE TRANSPORTATION SYSTEM PLAN



City of Prineville Transportation System Plan TAC/PAC Meeting #4 Handouts

Name:

Organization (if applicable):

Contact Information (E-mail or Phone Number):

The City of Prineville, in collaboration with Crook County and ODOT, is developing a transportation system plan that will identify connectivity, safety, and accessibility needs and priorities throughout the City for the next 20 years. When complete, this overall document will become the transportation chapter of the City's Comprehensive Plan.

Practically speaking, this plan will guide where future roadways, sidewalks, trails, transit service and other transportation infrastructure will be located to connect and serve the City's current and future residents, businesses, and attractions. This plan focuses on the higher-order "major" roadways within the City, which includes its highways, arterials, and collector facilities.

The attached figures highlight critical elements of this plan. Based on transportation needs identified and discussed at the last TAC/PAC meeting, we have identified several changes for discussion. The attached figures support the evaluation of alternatives conducted by the consulting team and illustrate opportunities to alleviate congestion, improve traffic safety for all users, and accommodate future growth. The proceeding pages include blank maps with space for your thoughts and comments.

We Want Your Comments!

We are sharing our analysis of several proposed alternatives with the intent that you will provide your input on the options we should include in the plan for the next 20 years. Please take a moment to look at the enclosed materials, and provide comments and a way for us to contact you should we have any questions regarding what you've provided.

Our next steps will be to review and compile the comments received. We will then identify a preferred package of projects to include in a cost-constrained plan that will be discussed with agencies, stakeholders, and the public in June.

Additional information on the project can be found at <http://sites.kittelson.com/PrinevilleTSP>, or by contacting Scott Edelman, Planning Director for the City of Prineville.

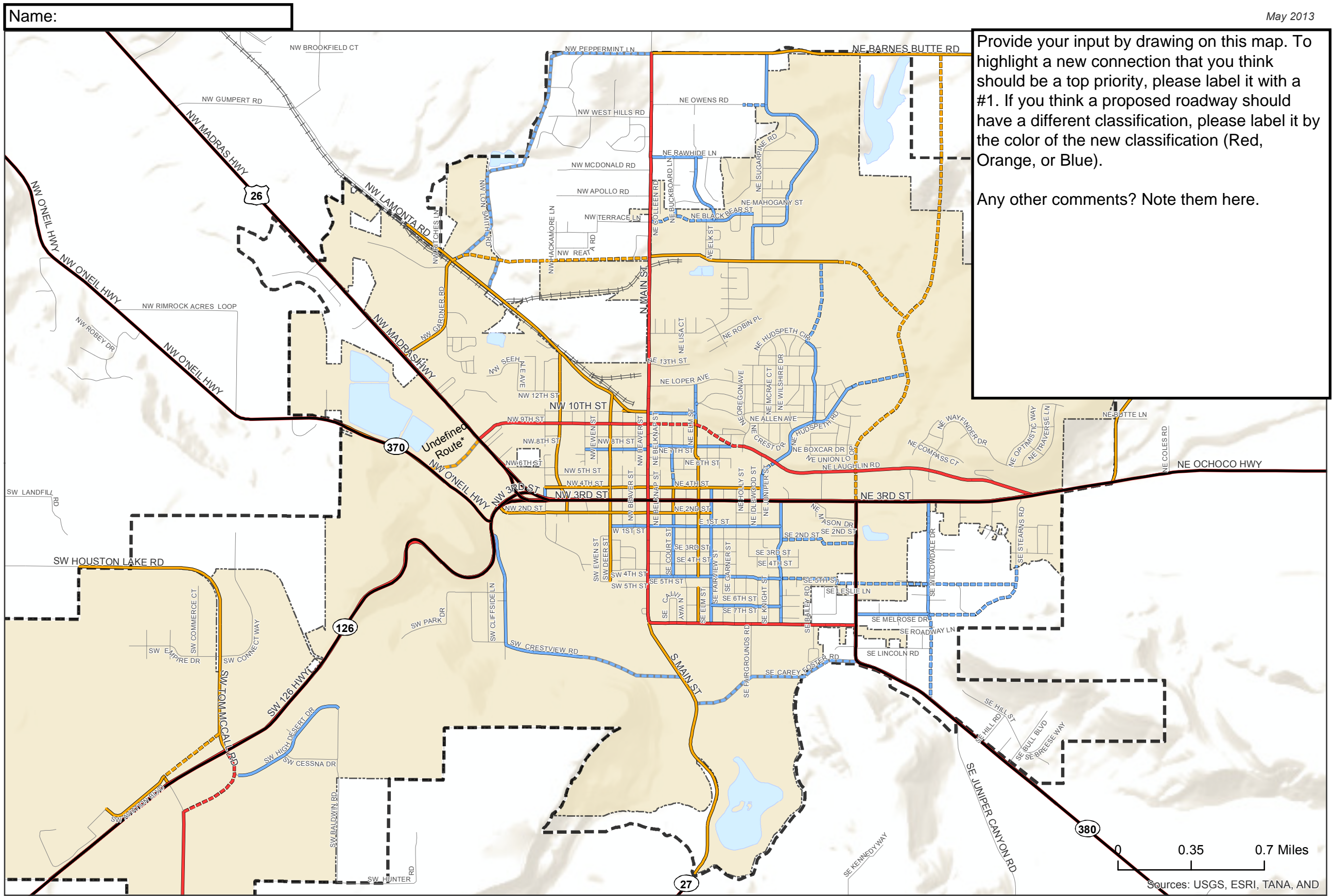
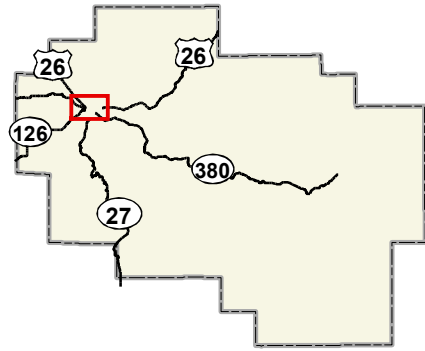

Functional Roadway Classifications

Major Arterial

Minor Arterial

Existing

Future

Vision

Major Collector

Existing

Future

Vision

Minor Collector

Existing

Future

Vision

City Boundary

Study Area/Urban Growth Boundary (UGB)

* OR 370 should be rerouted to connect with US 26, but is not needed within the 20-year planning horizon. Route is yet to be determined.

**Proposed Functional Classification
City of Prineville, Oregon**

**Figure
6-1**

Name:

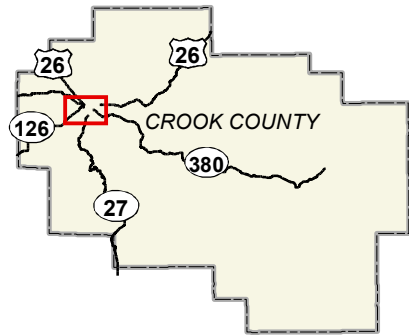

- Parallel Segments
- City Boundary
- Study Area/Urban Growth Boundary (UGB)

A range of parallel routes are identified here. After reviewing the evaluation matrix, which alternative routes do you prefer? Please write in the number of each parallel route in the order that you would rank them below.

- 1)
- 2)
- 3)
- 4)
- 5)

Any other comments?

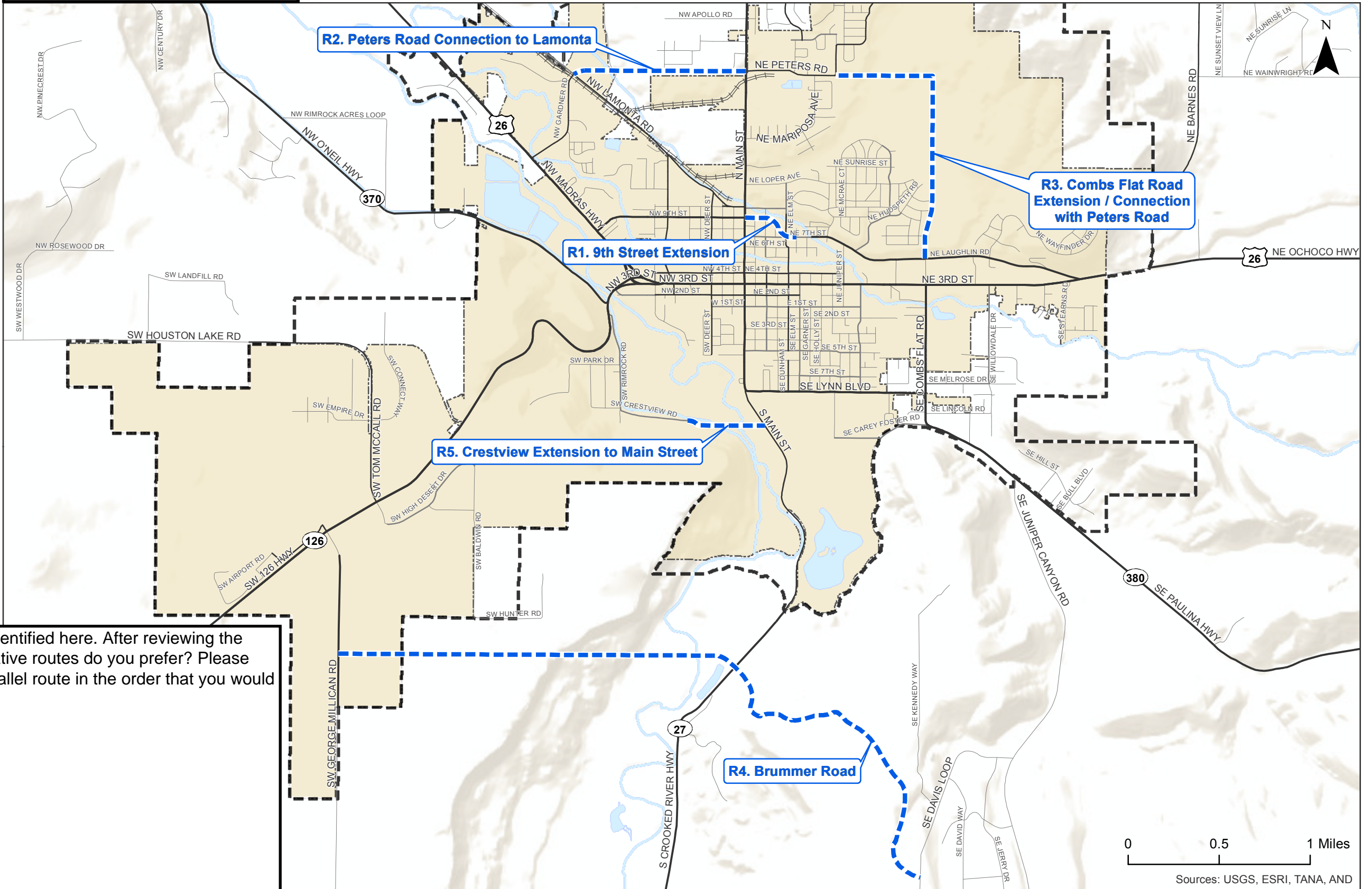

Sources: USGS, ESRI, TANA, AND

**Parallel Routes
City of Prineville, Oregon**

**Figure
6-2**

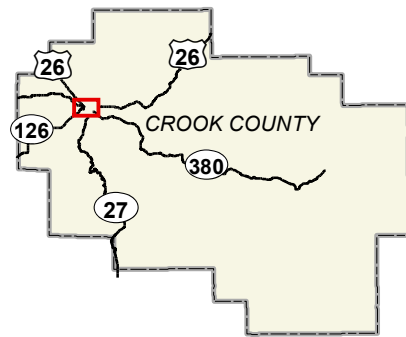

- Study Intersection Level-of-Service**
- "C" or Better
 - "D" or "E"
 - "F"
 - City Boundary
 - Study Area/Urban Growth Boundary (UGB)

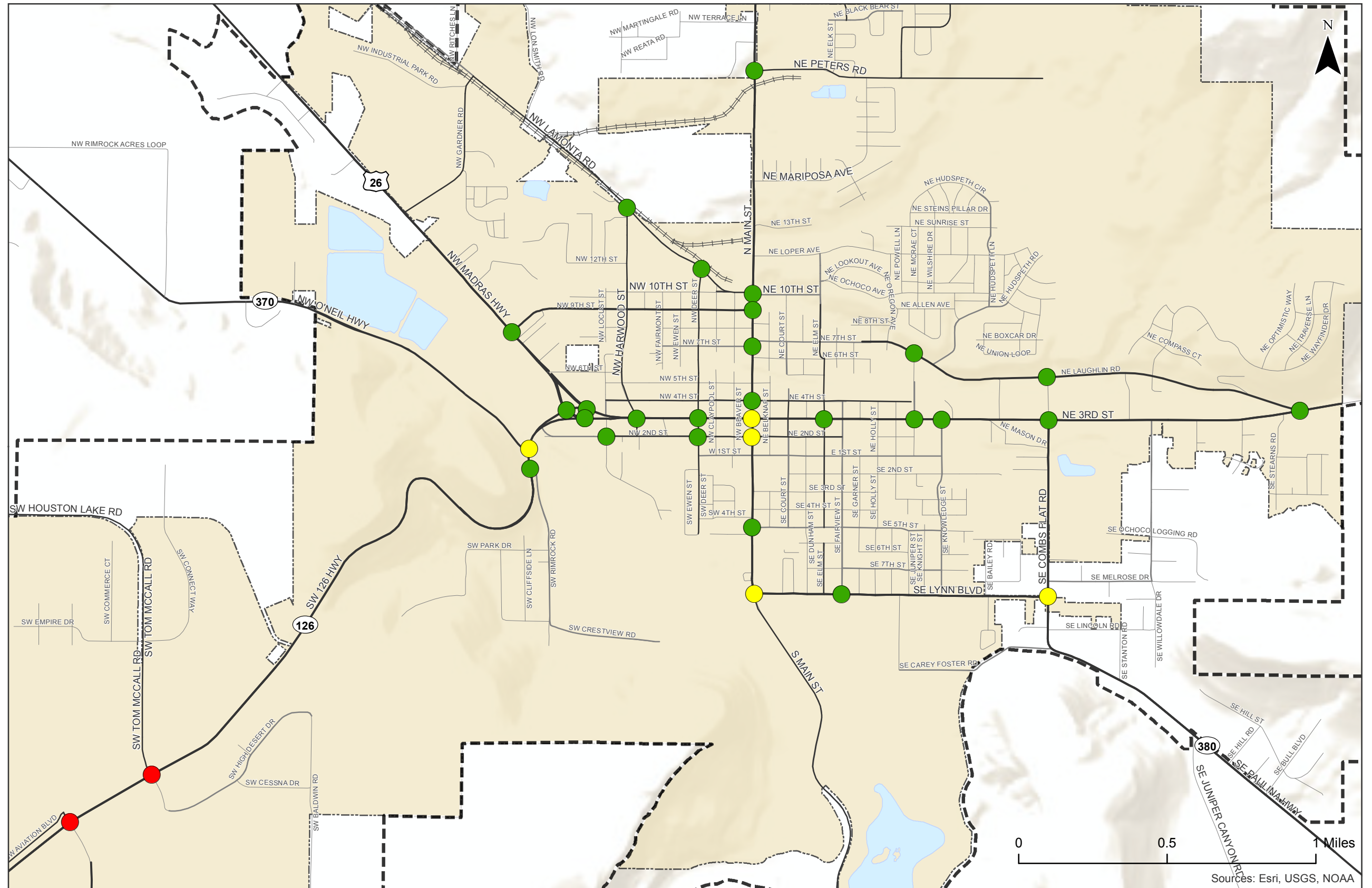

**Parallel Route Alternative - Study Intersections Operations
City of Prineville, Oregon**

**Figure
6-3**

K:\H_Portland\proj\12221 - Prineville TSP\GIS\Memo 616-2 Parallel Route Alternative - Study Intersections Operations.mxd - agriffin - 6:44 PM 5/3/2013

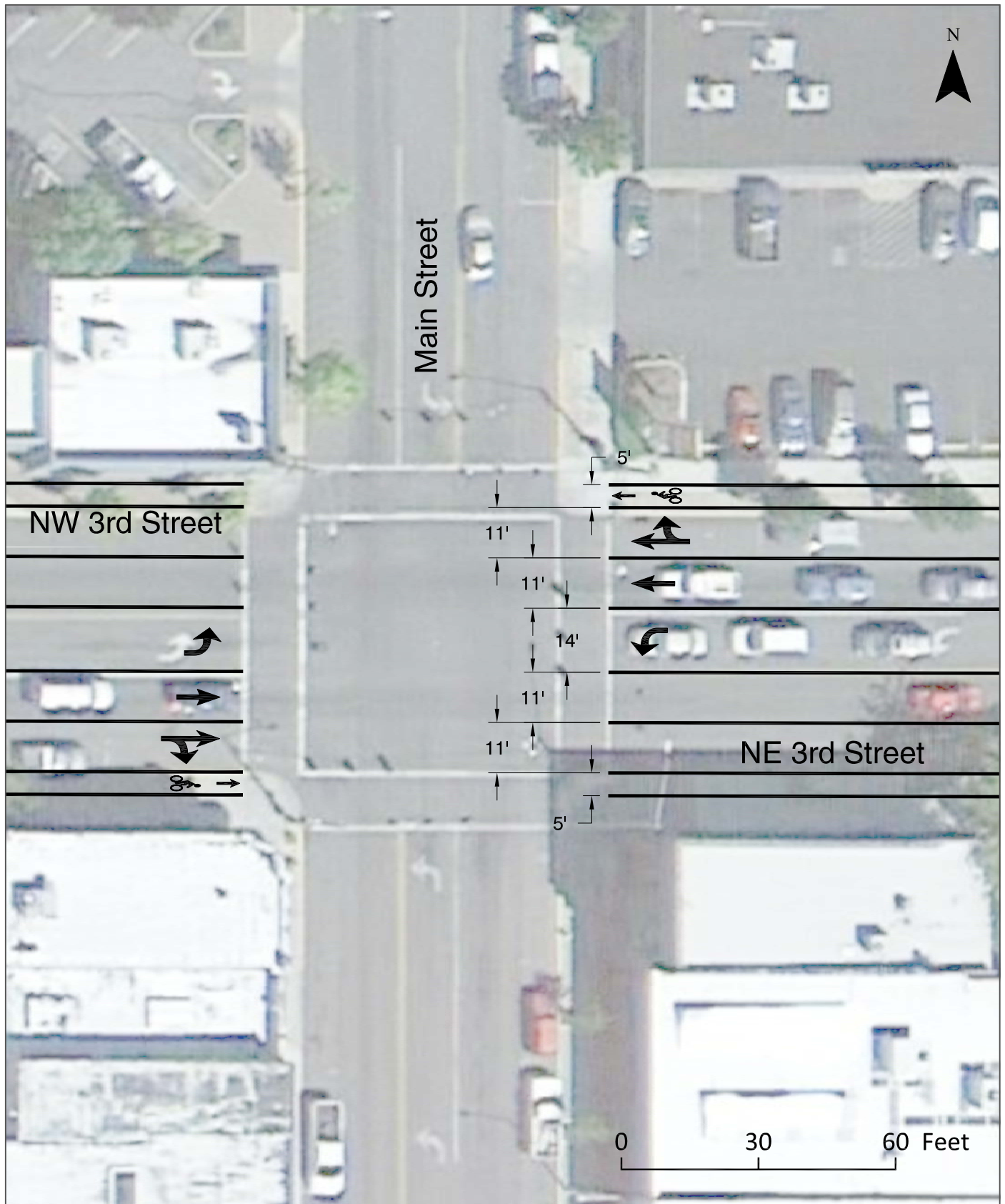

**Street Widening Impacts
City of Prineville, Oregon**

**Figure
6-4**

H:\proj\file12221 - Prineville TSP\dwg\figs\Memo6\Memo6_Fig01.dwg May 03, 2013 - 1:38pm - jsommerville Layout Tab: 6-3

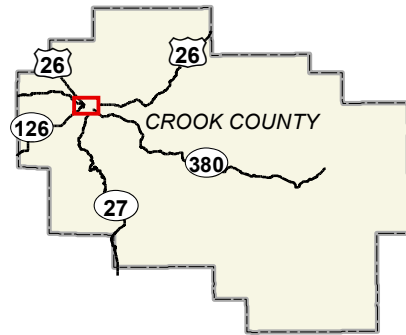

Study Intersection Level-of-Service

- "C" or Better
- "D" or "E"
- "F"
- City Boundary
- Study Area/Urban Growth Boundary (UGB)

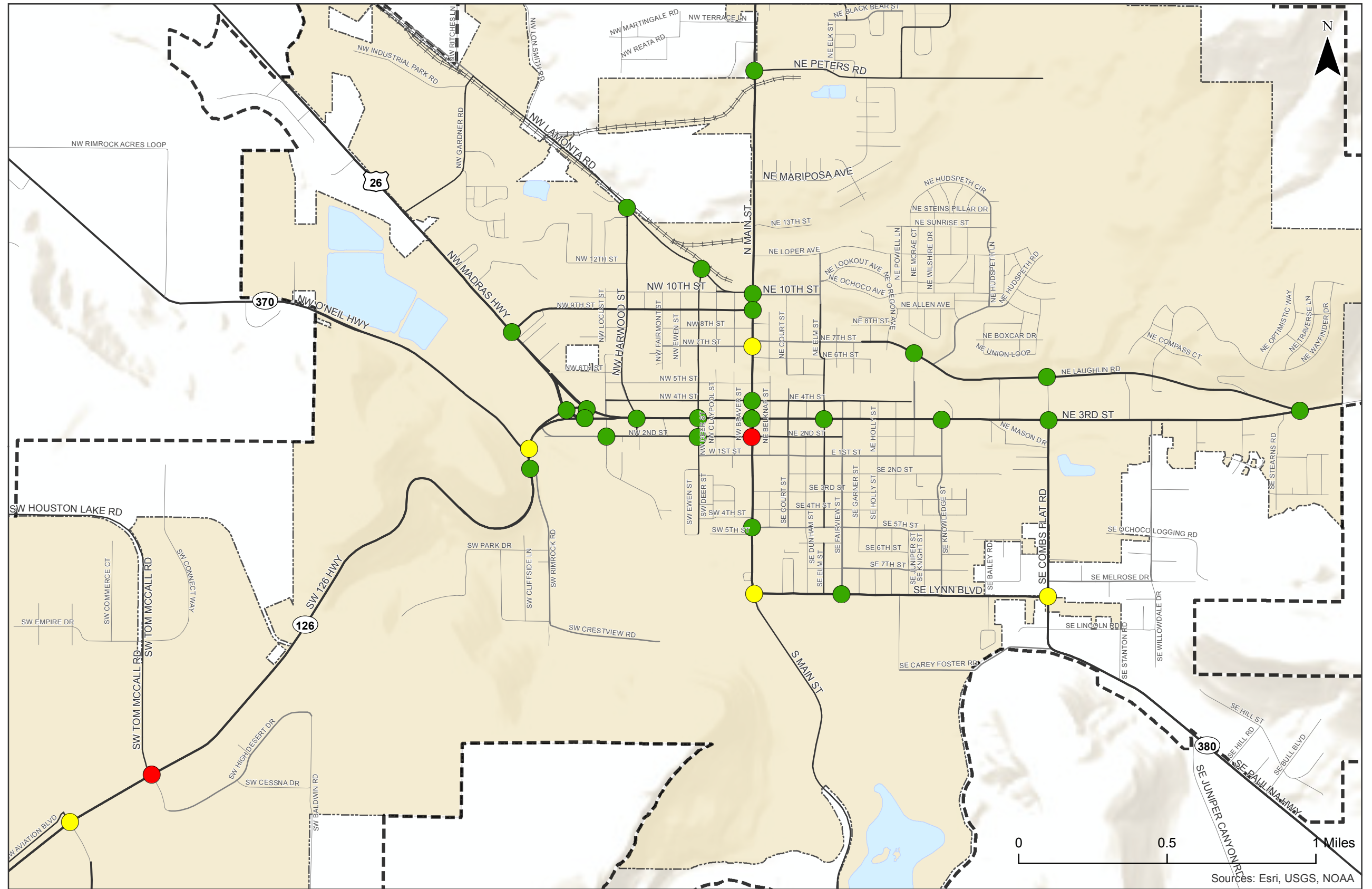

**Widened 3rd Street Alternative - Study Intersections Operations
City of Prineville, Oregon**

**Figure
6-5**

K:\H_Perland\proj\12221 - Prineville TSP\GIS\Memo 615-5-Widened 3rd Street Alternative - Study Intersections Operations.mxd - agriffin - 6:03 PM 5/3/2013

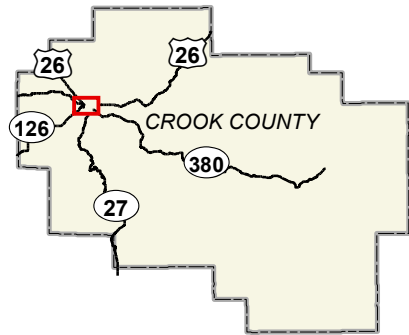

- Study Intersection Level-of-Service**
- "C" or Better
 - "D" or "E"
 - "F"
 - City Boundary
 - Study Area/Urban Growth Boundary (UGB)

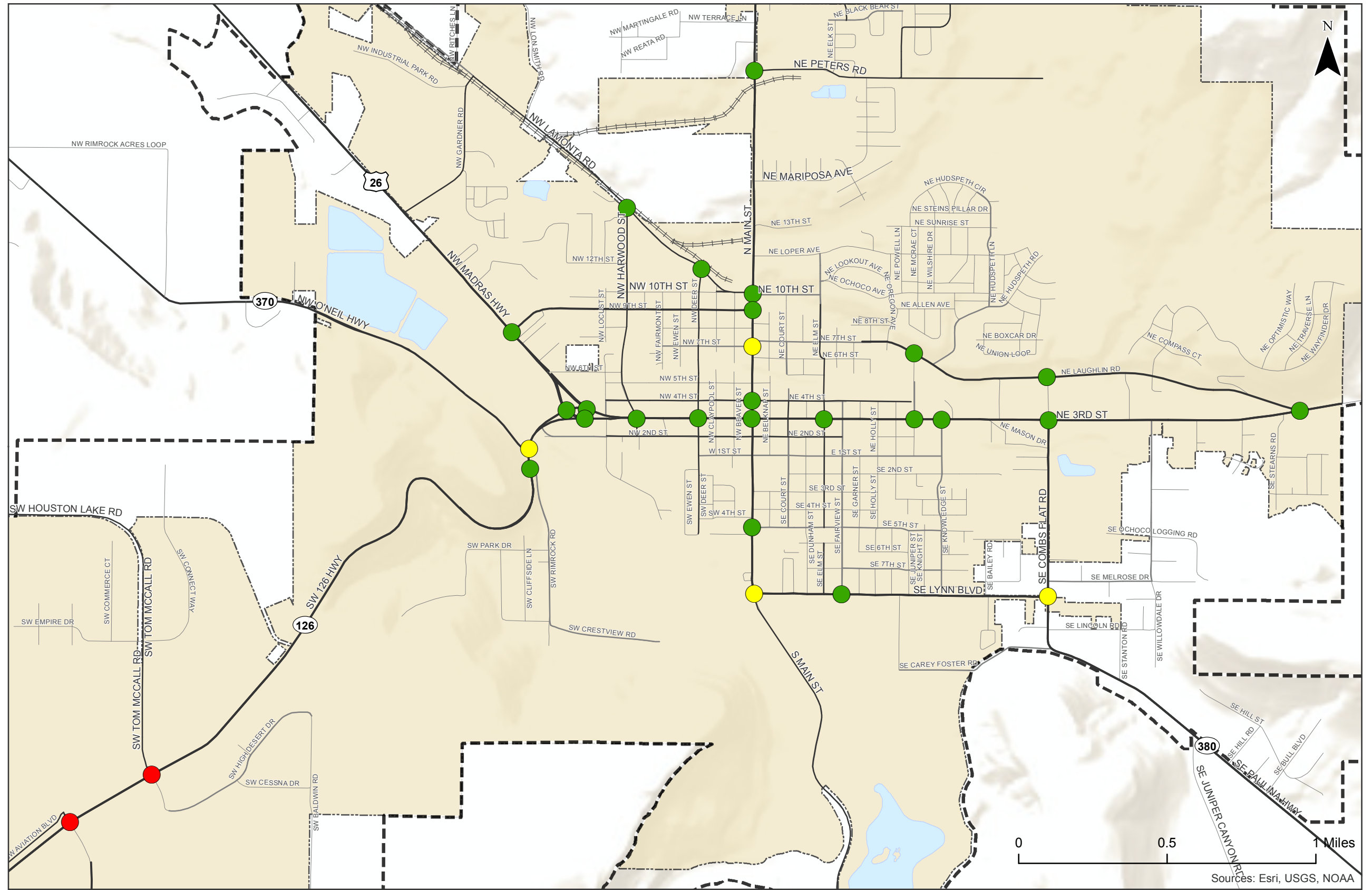

**Study Intersections Operations for 2nd and 3rd Street Couplet
City of Prineville, Oregon**

**Figure
6-8**

K:\H_Portland\profile12221 - Prineville TSP\GIS\Memo 618-6 Study Intersections Operations for 2nd and 3rd Street Couplet.mxd - openbrd - 6:39 PM 5/3/2013

3rd Street Corridor Alternatives Summary								
	Evaluation Criteria						Total Score	Cost per Trips Removed from 3rd Street (thousands)
	Construction Cost	Business Impact	Social Impact	Environmental Impact	Operational Impact			
Parallel Routes								
<i>9th Street Extension</i>	★	★	★	★	★	★	<\$50	
<i>Peters Road Extension</i>	★	★	★	★	★	★	<\$50	
<i>Combs Flat Road Extension</i>	★	★	★	★	★	★	>\$200	
<i>Brummer Road</i>	★	★	★	★	★	★	>\$200	
<i>Crestview Connection</i>	★	★	★	★	★	★	\$50-\$200	
2nd/3rd St Couplet	★	★	★	★	★	★	<\$50	
3rd/4th St Couplet	★	★	★	★	★	★	<\$50	
Corridor Widening	★	★	★	★	★	★	<\$50	

Do you agree or disagree with the relative ratings given to each alternative? If so, please provide your input below.

Multiple pedestrian facilities are proposed to increase active transportation alternatives in Prineville. Please review the proposed sidewalk and crossing projects identified on this map and rank the top 5 projects below.

- 1)
- 2)
- 3)
- 4)
- 5)

Please identify any additional pedestrian facilities that are needed and note any other comments.

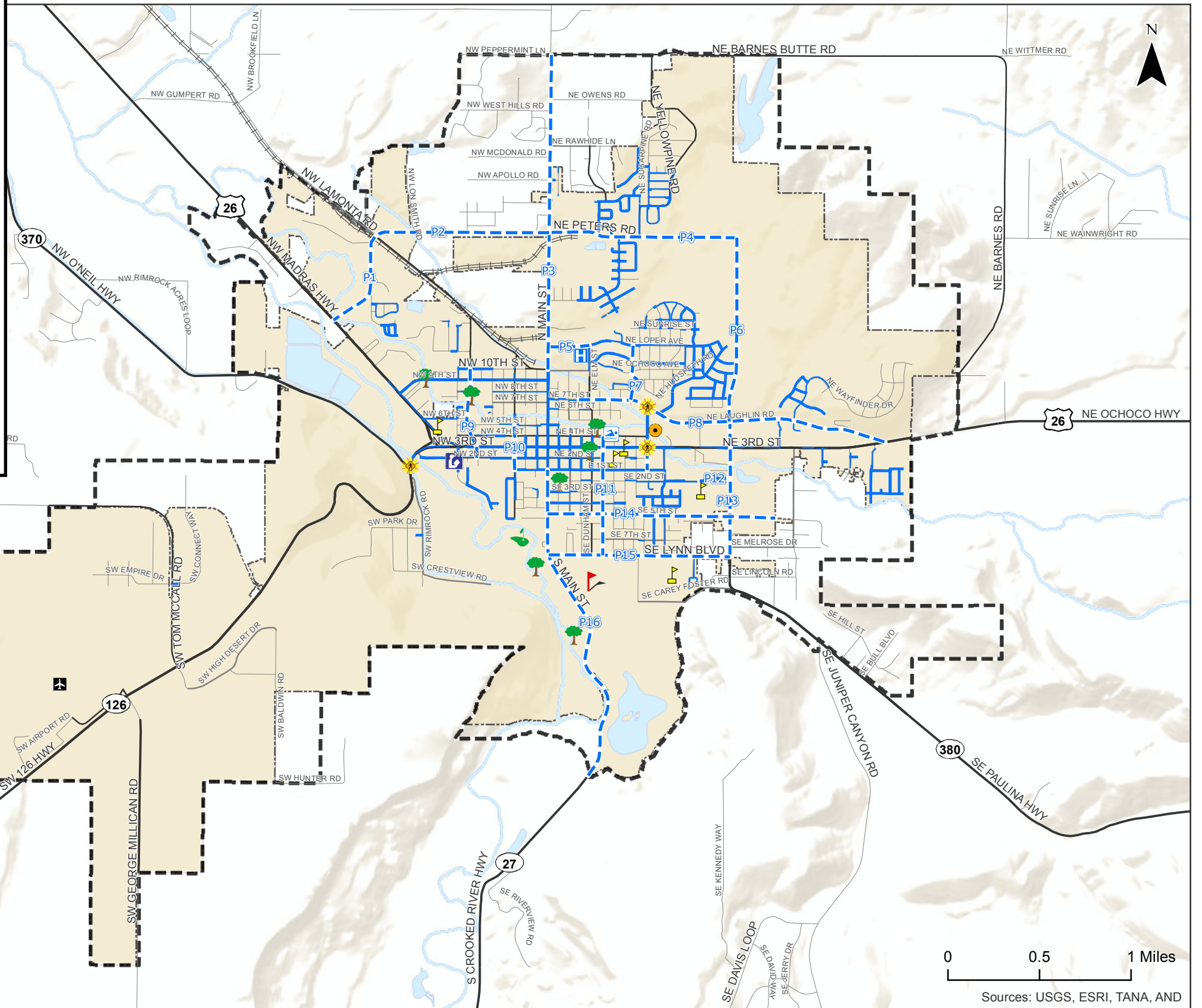

Destinations

- Airport
- Fairgrounds
- Golf Course
- Hospital
- Library
- Pool
- School
- Skatepark
- Park
- Proposed Crosswalk
- Proposed Sidewalks
- City Boundary
- Study Area/Urban Growth Boundary (UGB)

**Proposed Pedestrian Facilities
City of Prineville, Oregon**

**Figure
6-9**

H:\proj\12221 - Prineville TSP\GIS\Memo 616-9 Proposed Pedestrian Facilities.mxd - jsommerville - 2:55 PM 5/3/2013

Multiple pedestrian facilities are proposed to increase active transportation alternatives in Prineville. Please review the proposed bike lanes/routes identified on this map and rank the top 5 projects below.

- 1)
- 2)
- 3)
- 4)
- 5)

Please identify any additional routes that are needed and note any other comments.

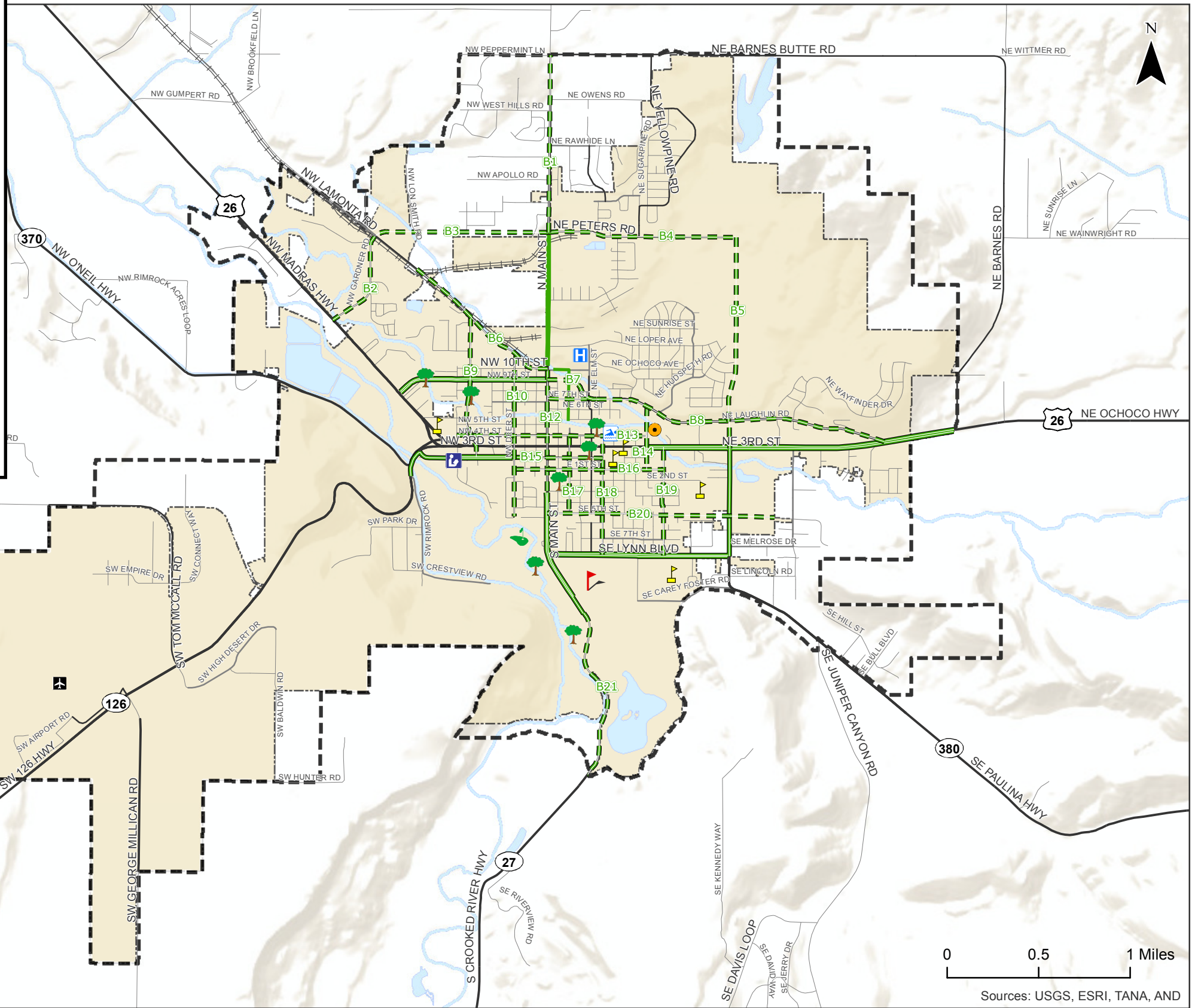

H:\projects\12221 - Prineville TSP\GIS\Memo 616-10 Proposed Bicycle Facilities.mxd - 4:21 PM 5/9/2013

**Proposed Bicycle Facilities
City of Prineville, Oregon**

**Figure
6-10**

Multiple pedestrian facilities are proposed to increase active transportation alternatives in Prineville. Please review the proposed multi-use trail routes identified on this map and rank the top 5 below.

- 1)
- 2)
- 3)
- 4)
- 5)

Please identify any additional suggested routes on the map and note any other comments.

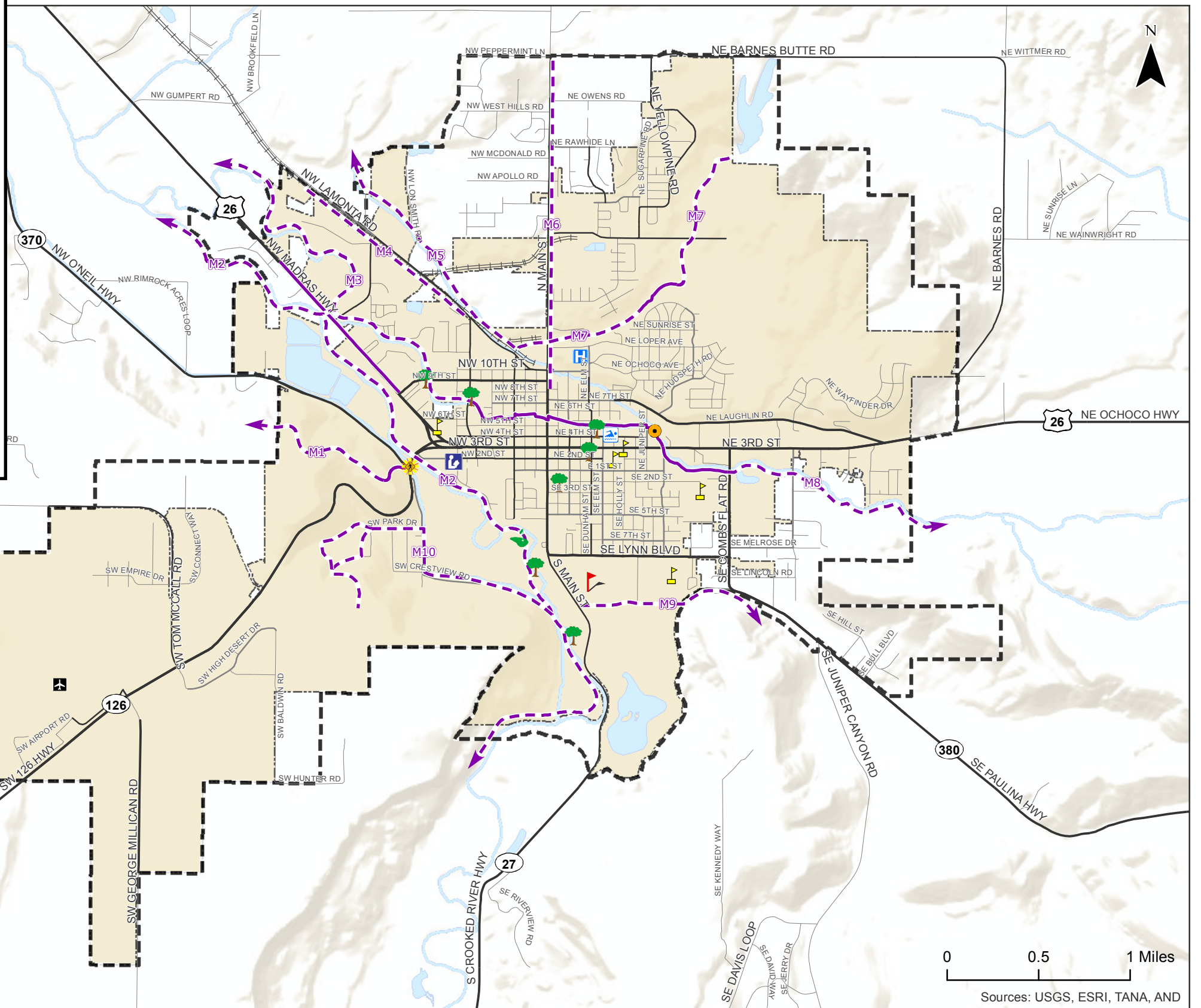

Destinations

- Airport
- Fairgrounds
- Golf Course
- Hospital
- Library
- Pool
- School
- Skatepark
- Park
- Proposed Crosswalk
- Existing Multi-Use Path
- Proposed Multi-Use Path
- City Boundary
- Study Area/Urban Growth Boundary (UGB)

**Proposed Multi-Use Trails
City of Prineville, Oregon**

**Figure
6-11**

H:\projects\12221 - Prineville TSP\GIS\Memo 616-11 Proposed Multi-Use Trails.mxd - jsommerville - 4:31 PM 5/3/2013



CITY OF PRINEVILLE TRANSPORTATION SYSTEM PLAN



Joint PAC/TAC Meeting #4 Minutes

Meeting Date: May 7, 2013

Meeting Time: 2:30 p.m.

Black text below reflects the meeting agenda, and all blue text reflects comments or input received.

Meeting Invitees:

TAC Members

PAC Members

Meeting Discussion:

Introductions, Meeting Goals

Summary of Meeting #3 Outcomes

- Future Needs
- Alternatives Development
- Comments Received

Future Network Alternatives

- Functional Classification

We need to distinguish between future and vision projects better on functional class map

- Cross-section
 - Steve had concern with protecting City staff with the cross-sections. He is worried that if we're not finite about street width, a developer can come in and just create the minimum width – the City staff will have to justify itself.
 - City council wants the variation so that they aren't too tied down.
 - Joe pointed out that the new TSP will provide a deviation process for scenarios when they do deviate from standards.
 - Scott – so will we have variations on right-of-way width or just pavement with the proposed cross-sections?
 - ROW width dependent upon classification standard – so we'll always have ROW, the pavement width can vary.
 - Scott E. – How do you deal with (or do you even want) bulb-outs on freight routes?
 - Joe – you wouldn't want them on a freight route.
- Access Management

3rd Street Corridor Alternative Evaluation

- Parallel Routes
 - Do we have enough money to fund these?
 - The funding will come from many sources: ODOT, private developers, SDC, etc... more specifics on funding sources and constraints will be presented that the next meeting in June.



CITY OF PRINEVILLE TRANSPORTATION SYSTEM PLAN



- Who will determine what projects get built first?
 - We'll discuss cost next time.
 - And development will drive some of that.
 - Be sure to incorporate new school measure and plans for the hospital when determining funding.
- Concern voiced that both of the parallel routes are pulling trips off of US 26, and with most of trips coming from Bend/Redmond, the couplet should still be an option, because most traffic still must pass through the Y.
 - We are keeping the couplet as a vision project in the plan.
- Would the Peters Road connection be more like 9th Street connection in terms of width and cross-section? Because commenter believes there will be more truck traffic there.
 - Yes, it will be.
- One commenter believes that improving signal timing and coordination should be the first priority as a low-cost way to improve capacity first before constructing anything.
 - Joe confirmed that this is a need for the City, with no coordination among signals currently.
 - Scott: ODOT says it's hard for them to get a consistent timing because people in town are nice and stop to let people turn out.
 - Inconsistent speed limits are also an issue.
- On the parallel routes: are you factoring in traffic controls at the end of them? Because even if the routes are shorter, if the wait time at signals is too long, people will go around anyways rather than using the parallel routes.
 - Couplet Options
- Steve – if we want to eventually go to couplet, we need to start planning for that now and get it in the TSP now.
 - Joe: We do want to plan for it now and pick the right-of-way so that we can start planning and acquiring ROW, etc.
- If we did go to a couplet, 2nd St or 4th St would become an ODOT facility.
- On the 2nd St school property – there's a recently renovated (put \$200,000 into the building) school based health center – would you move that? It's used by all schools.
 - If you look at the front of Crooked River Elementary, it's the building to the right. The building will probably be bypassed by the 2nd Street extension if it occurs.
- Other cities have done a 2nd/4th street couplet (versus a 2nd/3rd St or 3rd/4th St couplet) – why did we not consider this? Because ODOT facilities have standards, and right now neither is to standard. You would have to build two new roads instead of one.
- One commenter felt that the couplet option is fine as long as you don't ignore the simple improvements first: Crestview, 9th St, Peters Road.
- Development participation isn't there for couplet like it is for other options (more partners for these new roads in redevelopment areas – not much redevelopment going on around 2nd or 3rd Street)
 - Widening 3rd Street

No comments – everyone seemed to agree that this wasn't a desirable option.

- Alternative Mobility

Other Corridor Improvement Alternatives



CITY OF PRINEVILLE TRANSPORTATION SYSTEM PLAN



- Most people avoid Elm St because it has a stop sign on every block. So we would need to fix this if we wanted to make Elm Street a better connection.
 - Elm St concept has been in TSP for a long time. With the hospital moving, not quite as critical – but the hospital site might become something else.
 - The property needed to complete the Elm Street connection was recently in foreclosure – is it still? The City might be able to get it for a good price.
- 5th Street connection – must go around football field.

Intersection Improvement Alternatives

- Tom McCall – a signal wouldn't be as surprising as it would have been previously because of the new lower speed limit in that area.
 - But, that's a temporary lower speed limit for construction.
- Prineville “Y” – right now you have yield signs instead of merge signs – why?
 - The angle from a truck driver who stops at a yield line doesn't allow him to see if he pulls all the way to the yield line and stops. This needs consideration of redesign to better sight distance for truck drivers.
- The “Y” area – a lot of discussion from people about pedestrian safety in this area – pedestrians are trying to get across the Y to the library, etc.
 - Pedestrian connectivity is a big issue here
 - You're also going to see a big increase in bicycle traffic due to the increase in proposed trails in the area – we haven't addressed bicyclists at this intersection
 - A median with a pedestrian refuge would be helpful, near Meadow Lakes. Attendees seemed to like the idea.
 - Shifting the very short connection from OR 126 to US 26 to the west would help improve the Y.
 - Steve H – (since he lives on Meadow Lakes) he thinks it would make sense to allow WB left turn and allow pedestrian crossings on west side of intersection.
 - He thinks limiting RIRO only would be a substantial financial impact.
 - He doesn't think NB left turn on Meadow Lakes would be an issue if restricted – people already use Harwood.
 - People currently use the space in the intersection as an EB left turn lane, can we make an EB left turn lane?
 - Kittelson needs to bring back more options for the Y junction.
- O'Neil Highway / Rimrock Area:
 - Marty – When you get down to bridge on OR 126, you don't realize there is a 2nd street turn-off because it looks like a bike lane. Needs more signage to encourage people to use it.
 - Should look more like an exit.
 - Scott – part of the problem is the bike path at the intersection –there is confusion with the striping.
 - Wintertime maintenance would be an issue with putting a small pull-out lane at O'Neil Highway/OR 126 intersection.
 - How many people currently try to go across from O'Neil to Rimrock as of right now? This seems like it would be a dangerous maneuver.
 - Walmart and Home Depot have moved, so people now use O'Neil Highway to get to north end of Redmond, meaning more people are using O'Neil Highway.



CITY OF PRINEVILLE TRANSPORTATION SYSTEM PLAN



- Peters Rd/Main – more trains are expected across rail spur that were previously using that line, so we will need to account for that.
- 9th/10th at Main Street
 - Attendees do not want both intersections signalized.
 - Steve – could we shift the 10th St intersection north of railroad since RR tracks have been taken out?
 - Scott: Yes, we're trying to get 10th St aligned to a normal intersection and get coordination between 9th and 10th.
 - With more traffic on Lamonta and no longer any railroad tracks – could we bring the future 9th St connection further up to connect with Lamonta?
 - Acquisition costs may offset construction costs.
- TIA's for some of the new developments show the need for signals at Main/Lynn, but these TIA's assumed full build-out. In the TSP, we are proposing signals at the intersection of Main/Lynn when warranted.
- Laughlin/US 26 – attendees don't want this be a square right turn. They like that it's easy to turn right on Laughlin when heading WB on US 26. This is helpful when pulling trailers.
 - This is where the buses turn around. They like having the small island to turn around.
 - If you have to stop on the highway before turning, attendees think there would be more rear-ends.
 - Josh: if you make it a T intersection, keep the right turn lane.
 - Scott – this issue has been discussed with ODOT. If the City does anything, they have to do it all, including take away access from residents, add turn lanes, etc.
 - Other comments: if you connect the proposed northern alignment with 7th street, you will have more traffic at this intersection.
 - This intersection is probably a signage problem that could be improved with better signage and striping.

Safety Improvement Alternatives

- 2nd/Deer intersection – Comment from a local resident: half the people don't stop at all at the intersection. The other half the time, the issue is that there are parked cars up the road, closer to 3rd St, that limit visibility. So sometimes you can't see the traffic approaching.
 - 85% of traffic was over the speed limit at the last count taken.
 - Intersection is fine, culture is causing the problem.
 - What about the flashing stop signs?
 - Scott - it's a law enforcement issue. They need people to issue tickets to change the culture and get people to stop.
 - Keep this culture in mind as you plan other routes around the city – by designing straight routes, people are likely to speed.
- Main/4th
 - Congestion from 3rd Street is backing up to the intersection – this could be improved by improving the 3rd Street signal
 - Josh – there is a visibility issue with the parked cars. You can't see to pull-out.
- 3rd/Combs Flat - left turns are the issue here.
 - But you have ROW issues that will be restrictive for widening the road.
 - Flashing yellow lights would be good on 3rd street.
- 3rd/Harwood – rear-end crashes are common here.
 - The number of driveways in this area is high.



CITY OF PRINEVILLE TRANSPORTATION SYSTEM PLAN



- One commenter thinks that a lot of this is due to frustration from being stuck in the Y – people speed up when they are able to.

Active Transportation Alternatives

- Laughlin – a crosswalk has been installed here now.
- Main Street (north side of City) – maps show multi-use trail and sidewalks, verify which one this is.

Funding Options: Will be discussed at the next meeting.

Additional Comments/Questions and Summary of Identified Action Items

Next meeting: June 4, 2013 at 2:30 p.m.

Appendix E Intersection
Performance
Technical Output
for Parallel Routes
Alternative

HCM Unsignalized Intersection Capacity Analysis

1: Lamonta Rd & Harwood St

5/2/2013

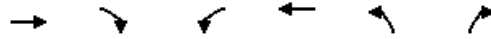

Movement	EBT	EBR	WBL	WBT	NBL	NBR
Lane Configurations	↔			↔		↔
Volume (veh/h)	165	50	40	120	15	40
Sign Control	Free			Free	Stop	
Grade	0%			0%	0%	
Peak Hour Factor	0.75	0.75	0.75	0.75	0.75	0.75
Hourly flow rate (vph)	220	67	53	160	20	53
Pedestrians						
Lane Width (ft)						
Walking Speed (ft/s)						
Percent Blockage						
Right turn flare (veh)						
Median type	None			None		
Median storage (veh)						
Upstream signal (ft)						
pX, platoon unblocked						
vC, conflicting volume			287		520	253
vC1, stage 1 conf vol						
vC2, stage 2 conf vol						
vCu, unblocked vol			287		520	253
tC, single (s)			4.1		6.4	6.2
tC, 2 stage (s)						
tF (s)			2.2		3.5	3.3
p0 queue free %			96		96	93
cM capacity (veh/h)			1287		498	790
Direction, Lane #	EB 1	WB 1	NB 1			
Volume Total	287	213	73			
Volume Left	0	53	20			
Volume Right	67	0	53			
cSH	1700	1287	681			
Volume to Capacity	0.17	0.04	0.11			
Queue Length 95th (ft)	0	3	9			
Control Delay (s)	0.0	2.3	10.9			
Lane LOS		A	B			
Approach Delay (s)	0.0	2.3	10.9			
Approach LOS			B			
Intersection Summary						
Average Delay			2.2			
Intersection Capacity Utilization			35.6%	ICU Level of Service	A	
Analysis Period (min)			15			

HCM Unsignalized Intersection Capacity Analysis

2: Deer St & Lamonta Rd

5/2/2013



Movement	EBT	EBR	WBL	WBT	NBL	NBR
Lane Configurations	↔			↔		↔
Volume (veh/h)	185	30	5	140	25	10
Sign Control	Free			Free	Stop	
Grade	0%			0%	0%	
Peak Hour Factor	0.86	0.86	0.86	0.86	0.86	0.86
Hourly flow rate (vph)	215	35	6	163	29	12
Pedestrians						
Lane Width (ft)						
Walking Speed (ft/s)						
Percent Blockage						
Right turn flare (veh)						
Median type	None			None		
Median storage (veh)						
Upstream signal (ft)	697					
pX, platoon unblocked						
vC, conflicting volume			250		407	233
vC1, stage 1 conf vol						
vC2, stage 2 conf vol						
vCu, unblocked vol			250		407	233
tC, single (s)			4.1		6.5	6.3
tC, 2 stage (s)						
tF (s)			2.2		3.6	3.4
p0 queue free %			100		95	99
cM capacity (veh/h)			1327		581	787
Direction, Lane #	EB 1	WB 1	NB 1			
Volume Total	250	169	41			
Volume Left	0	6	29			
Volume Right	35	0	12			
cSH	1700	1327	628			
Volume to Capacity	0.15	0.00	0.06			
Queue Length 95th (ft)	0	0	5			
Control Delay (s)	0.0	0.3	11.1			
Lane LOS		A	B			
Approach Delay (s)	0.0	0.3	11.1			
Approach LOS			B			
Intersection Summary						
Average Delay			1.1			
Intersection Capacity Utilization			22.5%	ICU Level of Service	A	
Analysis Period (min)	15					

Queues

3: Main St & 10th St

12/12/2013





















Lane Group	EBL	EBT	WBT	NBL	NBT	SBL	SBT
Lane Group Flow (vph)	160	199	87	125	571	10	678
v/c Ratio	0.62	0.44	0.28	0.48	0.60	0.03	0.71
Control Delay	30.3	9.3	16.6	14.1	9.9	5.0	12.6
Queue Delay	0.0	0.0	0.0	0.0	0.0	0.0	0.0
Total Delay	30.3	9.3	16.6	14.1	9.9	5.0	12.6
Queue Length 50th (ft)	35	8	14	17	83	1	112
Queue Length 95th (ft)	85	36	42	40	119	5	153
Internal Link Dist (ft)		370	379		203		3918
Turn Bay Length (ft)							
Base Capacity (vph)	347	548	435	379	1372	535	1382
Starvation Cap Reductn	0	0	0	0	0	0	0
Spillback Cap Reductn	0	0	0	0	0	0	0
Storage Cap Reductn	0	0	0	0	0	0	0
Reduced v/c Ratio	0.46	0.36	0.20	0.33	0.42	0.02	0.49

Intersection Summary

HCM Signalized Intersection Capacity Analysis

3: Main St & 10th St

12/12/2013



















												
Movement	EBL	EBT	EBR	WBL	WBT	WBR	NBL	NBT	NBR	SBL	SBT	SBR
Lane Configurations												
Volume (vph)	115	28	115	16	34	13	90	367	44	7	452	36
Ideal Flow (vphpl)	1750	1750	1750	1750	1750	1750	1750	1750	1750	1750	1750	1750
Total Lost time (s)	5.0	5.0			5.0		5.0	5.0		5.0	5.0	
Lane Util. Factor	1.00	1.00			1.00		1.00	1.00		1.00	1.00	
Fr _t	1.00	0.88			0.97		1.00	0.98		1.00	0.99	
Fl _t Protected	0.95	1.00			0.99		0.95	1.00		0.95	1.00	
Satd. Flow (prot)	1614	1491			1634		1498	1679		1662	1692	
Fl _t Permitted	0.70	1.00			0.88		0.30	1.00		0.37	1.00	
Satd. Flow (perm)	1190	1491			1451		466	1679		656	1692	
Peak-hour factor, PHF	0.72	0.72	0.72	0.72	0.72	0.72	0.72	0.72	0.72	0.72	0.72	0.72
Adj. Flow (vph)	160	39	160	22	47	18	125	510	61	10	628	50
RTOR Reduction (vph)	0	125	0	0	14	0	0	8	0	0	5	0
Lane Group Flow (vph)	160	74	0	0	73	0	125	563	0	10	673	0
Heavy Vehicles (%)	3%	0%	4%	3%	0%	10%	11%	2%	7%	0%	2%	6%
Turn Type	Perm	NA		Perm	NA		Perm	NA		Perm	NA	
Protected Phases		4			8			2			6	
Permitted Phases	4			8			2			6		
Actuated Green, G (s)	10.0	10.0			10.0		25.8	25.8		25.8	25.8	
Effective Green, g (s)	10.0	10.0			10.0		25.8	25.8		25.8	25.8	
Actuated g/C Ratio	0.22	0.22			0.22		0.56	0.56		0.56	0.56	
Clearance Time (s)	5.0	5.0			5.0		5.0	5.0		5.0	5.0	
Vehicle Extension (s)	3.0	3.0			3.0		3.0	3.0		3.0	3.0	
Lane Grp Cap (vph)	259	325			316		262	945		369	953	
v/s Ratio Prot		0.05						0.34			c0.40	
v/s Ratio Perm	c0.13				0.05		0.27			0.02		
v/c Ratio	0.62	0.23			0.23		0.48	0.60		0.03	0.71	
Uniform Delay, d ₁	16.2	14.7			14.7		6.0	6.6		4.4	7.2	
Progression Factor	1.00	1.00			1.00		1.00	1.00		1.00	1.00	
Incremental Delay, d ₂	4.3	0.4			0.4		1.4	1.0		0.0	2.4	
Delay (s)	20.5	15.1			15.1		7.3	7.6		4.5	9.7	
Level of Service	C	B			B		A	A		A	A	
Approach Delay (s)		17.5			15.1			7.5			9.6	
Approach LOS		B			B			A			A	
Intersection Summary												
HCM 2000 Control Delay			10.6				HCM 2000 Level of Service			B		
HCM 2000 Volume to Capacity ratio			0.68									
Actuated Cycle Length (s)			45.8				Sum of lost time (s)			10.0		
Intersection Capacity Utilization			63.3%				ICU Level of Service			B		
Analysis Period (min)			15									

c Critical Lane Group

HCM Unsignalized Intersection Capacity Analysis

4: Main St & 9th St



















12/12/2013

												
Movement	EBL	EBT	EBR	WBL	WBT	WBR	NBL	NBT	NBR	SBL	SBT	SBR
Lane Configurations												
Volume (veh/h)	33	5	95	1	2	4	138	480	29	20	453	74
Sign Control		Stop			Stop			Free			Free	
Grade		0%			0%			0%			0%	
Peak Hour Factor	0.95	0.95	0.95	0.95	0.95	0.95	0.95	0.95	0.95	0.95	0.95	0.95
Hourly flow rate (vph)	35	5	100	1	2	4	145	505	31	21	477	78
Pedestrians												
Lane Width (ft)												
Walking Speed (ft/s)												
Percent Blockage												
Right turn flare (veh)												
Median type	TWLTL								None			
Median storage (veh)	2											
Upstream signal (ft)									283			
pX, platoon unblocked												
vC, conflicting volume	1320	1345	477	1433	1408	521	555			536		
vC1, stage 1 conf vol	519	519		811	811							
vC2, stage 2 conf vol	801	826		622	597							
vCu, unblocked vol	1320	1345	477	1433	1408	521	555			536		
tC, single (s)	7.1	6.5	6.2	7.1	6.5	6.2	4.1			4.1		
tC, 2 stage (s)	6.1	5.5		6.1	5.5							
tF (s)	3.5	4.0	3.3	3.5	4.0	3.3	2.2			2.2		
p0 queue free %	87	98	83	99	99	99	86			98		
cM capacity (veh/h)	267	282	592	202	259	560	1011			1042		
Direction, Lane #												
	EB 1	WB 1	NB 1	NB 2	SB 1	SB 2						
Volume Total	140	7	145	536	498	78						
Volume Left	35	1	145	0	21	0						
Volume Right	100	4	0	31	0	78						
cSH	441	353	1011	1700	1042	1700						
Volume to Capacity	0.32	0.02	0.14	0.32	0.02	0.05						
Queue Length 95th (ft)	35	2	13	0	2	0						
Control Delay (s)	16.9	15.4	9.2	0.0	0.6	0.0						
Lane LOS	C	C	A		A							
Approach Delay (s)	16.9	15.4	2.0		0.5							
Approach LOS	C	C										
Intersection Summary												
Average Delay			2.9									
Intersection Capacity Utilization			80.8%		ICU Level of Service				D			
Analysis Period (min)			15									

HCM Unsignalized Intersection Capacity Analysis

5: Main St & 7th St

5/2/2013

													
Movement	EBL	EBT	EBR	WBL	WBT	WBR	NBL	NBT	NBR	SBL	SBT	SBR	
Lane Configurations													
Volume (veh/h)	5	5	15	30	0	31	15	385	60	120	265	5	
Sign Control		Stop			Stop			Free			Free		
Grade		0%			0%			0%			0%		
Peak Hour Factor	0.94	0.94	0.94	0.94	0.94	0.94	0.94	0.94	0.94	0.94	0.94	0.94	
Hourly flow rate (vph)	5	5	16	32	0	33	16	410	64	128	282	5	
Pedestrians		4			9			1			1		
Lane Width (ft)		12.0			12.0			12.0			12.0		
Walking Speed (ft/s)		4.0			4.0			4.0			4.0		
Percent Blockage		0			1			0			0		
Right turn flare (veh)													
Median type								TWLTL			TWLTL		
Median storage (veh)								2			2		
Upstream signal (ft)											827		
pX, platoon unblocked													
vC, conflicting volume	1019	1058	290	1039	1029	451	291			482			
vC1, stage 1 conf vol	544	544		482	482								
vC2, stage 2 conf vol	475	514		557	547								
vCu, unblocked vol	1019	1058	290	1039	1029	451	291			482			
tC, single (s)	7.1	6.5	6.2	7.1	6.5	6.3	4.2			4.1			
tC, 2 stage (s)	6.1	5.5		6.1	5.5								
tF (s)	3.5	4.0	3.3	3.5	4.0	3.4	2.3			2.2			
p0 queue free %	98	98	98	91	100	94	99			88			
cM capacity (veh/h)	340	339	751	366	379	595	1233			1067			
Direction, Lane #	EB 1	WB 1	NB 1	NB 2	SB 1	SB 2							
Volume Total	27	65	16	473	128	287							
Volume Left	5	32	16	0	128	0							
Volume Right	16	33	0	64	0	5							
cSH	506	455	1233	1700	1067	1700							
Volume to Capacity	0.05	0.14	0.01	0.28	0.12	0.17							
Queue Length 95th (ft)	4	13	1	0	11	0							
Control Delay (s)	12.5	14.2	8.0	0.0	8.8	0.0							
Lane LOS	B	B	A		A								
Approach Delay (s)	12.5	14.2	0.3		2.7								
Approach LOS	B	B											
Intersection Summary													
Average Delay			2.5										
Intersection Capacity Utilization			51.7%		ICU Level of Service					A			
Analysis Period (min)			15										

HCM Unsignalized Intersection Capacity Analysis

6: Juniper St & Laughlin Rd

5/2/2013



















Movement	EBT	EBR	WBL	WBT	NBL	NBR
Lane Configurations	↔			↔	↔	
Volume (veh/h)	317	30	50	286	25	70
Sign Control	Free			Free	Stop	
Grade	0%			0%	0%	
Peak Hour Factor	0.96	0.96	0.96	0.96	0.96	0.96
Hourly flow rate (vph)	330	31	52	298	26	73
Pedestrians	1			1		
Lane Width (ft)	12.0			12.0		
Walking Speed (ft/s)	4.0			4.0		
Percent Blockage	0			0		
Right turn flare (veh)						
Median type	None			None		
Median storage (veh)						
Upstream signal (ft)						
pX, platoon unblocked						
vC, conflicting volume			361		749	347
vC1, stage 1 conf vol						
vC2, stage 2 conf vol						
vCu, unblocked vol			361		749	347
tC, single (s)			4.1		6.4	6.2
tC, 2 stage (s)						
tF (s)			2.2		3.5	3.3
p0 queue free %			96		93	90
cM capacity (veh/h)			1208		366	700
Direction, Lane #	EB 1	WB 1	NB 1			
Volume Total	361	350	99			
Volume Left	0	52	26			
Volume Right	31	0	73			
cSH	1700	1208	564			
Volume to Capacity	0.21	0.04	0.18			
Queue Length 95th (ft)	0	4	16			
Control Delay (s)	0.0	1.6	12.7			
Lane LOS		A	B			
Approach Delay (s)	0.0	1.6	12.7			
Approach LOS			B			
Intersection Summary						
Average Delay			2.2			
Intersection Capacity Utilization			55.9%		ICU Level of Service	B
Analysis Period (min)			15			

HCM Unsignalized Intersection Capacity Analysis

7: Combs Flat Rd & Laughlin Rd



















5/2/2013

												
Movement	EBL	EBT	EBR	WBL	WBT	WBR	NBL	NBT	NBR	SBL	SBT	SBR
Lane Configurations												
Volume (veh/h)	55	152	150	30	101	10	55	75	45	5	30	45
Sign Control		Free			Free			Stop			Stop	
Grade		0%			0%			0%			0%	
Peak Hour Factor	0.89	0.89	0.89	0.89	0.89	0.89	0.89	0.89	0.89	0.89	0.89	0.89
Hourly flow rate (vph)	62	171	169	34	113	11	62	84	51	6	34	51
Pedestrians												
Lane Width (ft)												
Walking Speed (ft/s)												
Percent Blockage												
Right turn flare (veh)												
Median type		None			None							
Median storage (veh)												
Upstream signal (ft)												
pX, platoon unblocked												
vC, conflicting volume	125			339			633	571	255	658	649	119
vC1, stage 1 conf vol												
vC2, stage 2 conf vol												
vCu, unblocked vol	125			339			633	571	255	658	649	119
tC, single (s)	4.1			4.1			7.2	6.5	6.2	7.1	6.5	6.2
tC, 2 stage (s)												
tF (s)	2.2			2.2			3.6	4.0	3.3	3.5	4.0	3.3
p0 queue free %	96			97			81	79	94	98	91	95
cM capacity (veh/h)	1474			1231			323	404	788	284	364	938
Direction, Lane #	EB 1	WB 1	NB 1	SB 1								
Volume Total	401	158	197	90								
Volume Left	62	34	62	6								
Volume Right	169	11	51	51								
cSH	1474	1231	424	541								
Volume to Capacity	0.04	0.03	0.46	0.17								
Queue Length 95th (ft)	3	2	62	15								
Control Delay (s)	1.5	1.9	20.6	13.0								
Lane LOS	A	A	C	B								
Approach Delay (s)	1.5	1.9	20.6	13.0								
Approach LOS			C	B								
Intersection Summary												
Average Delay			7.2									
Intersection Capacity Utilization			50.8%		ICU Level of Service				A			
Analysis Period (min)			15									

HCM Unsignalized Intersection Capacity Analysis

8: Main St & 4th St N

5/2/2013

												
Movement	EBL	EBT	EBR	WBL	WBT	WBR	NBL	NBT	NBR	SBL	SBT	SBR
Lane Configurations												
Volume (veh/h)	25	20	100	30	10	75	40	355	80	65	250	10
Sign Control		Stop			Stop			Free			Free	
Grade		0%			0%			0%			0%	
Peak Hour Factor	0.92	0.92	0.92	0.92	0.92	0.92	0.92	0.92	0.92	0.92	0.92	0.92
Hourly flow rate (vph)	27	22	109	33	11	82	43	386	87	71	272	11
Pedestrians		4			10			9			11	
Lane Width (ft)		12.0			12.0			12.0			12.0	
Walking Speed (ft/s)		4.0			4.0			4.0			4.0	
Percent Blockage		0			1			1			1	
Right turn flare (veh)												
Median type								None			TWLTL	
Median storage (veh)											2	
Upstream signal (ft)								331				
pX, platoon unblocked	0.84	0.84		0.84	0.84	0.84				0.84		
vC, conflicting volume	993	992	290	1068	954	450	287			483		
vC1, stage 1 conf vol	422	422		526	526							
vC2, stage 2 conf vol	571	570		542	428							
vCu, unblocked vol	895	894	290	984	848	247	287			286		
tC, single (s)	7.1	6.6	6.2	7.2	6.5	6.2	4.2			4.1		
tC, 2 stage (s)	6.1	5.6		6.2	5.5							
tF (s)	3.5	4.1	3.3	3.6	4.0	3.3	2.3			2.2		
p0 queue free %	92	94	85	89	97	88	97			93		
cM capacity (veh/h)	332	360	741	303	405	656	1249			1056		
Direction, Lane #	EB 1	WB 1	NB 1	NB 2	SB 1	SB 2						
Volume Total	158	125	43	473	71	283						
Volume Left	27	33	43	0	71	0						
Volume Right	109	82	0	87	0	11						
cSH	545	483	1249	1700	1056	1700						
Volume to Capacity	0.29	0.26	0.03	0.28	0.07	0.17						
Queue Length 95th (ft)	31	27	3	0	6	0						
Control Delay (s)	14.3	15.0	8.0	0.0	8.7	0.0						
Lane LOS	B	C	A		A							
Approach Delay (s)	14.3	15.0	0.7		1.7							
Approach LOS	B	C										
Intersection Summary												
Average Delay			4.4									
Intersection Capacity Utilization			52.3%		ICU Level of Service					A		
Analysis Period (min)			15									

HCM Unsignalized Intersection Capacity Analysis

9: 9th St & US 26

5/2/2013



Movement	WBL	WBR	NBT	NBR	SBL	SBT
Lane Configurations	Y		Y			Y
Volume (veh/h)	50	61	124	60	27	133
Sign Control	Stop		Free			Free
Grade	0%		0%			0%
Peak Hour Factor	0.85	0.85	0.85	0.85	0.85	0.85
Hourly flow rate (vph)	59	72	146	71	32	156
Pedestrians	12					
Lane Width (ft)	12.0					
Walking Speed (ft/s)	4.0					
Percent Blockage	1					
Right turn flare (veh)						
Median type			None			None
Median storage (veh)						
Upstream signal (ft)						
pX, platoon unblocked						
vC, conflicting volume	413	193			228	
vC1, stage 1 conf vol						
vC2, stage 2 conf vol						
vCu, unblocked vol	413	193			228	
tC, single (s)	6.5	6.3			4.2	
tC, 2 stage (s)						
tF (s)	3.6	3.4			2.3	
p0 queue free %	89	91			98	
cM capacity (veh/h)	553	827			1281	
Direction, Lane #	WB 1	NB 1	SB 1			
Volume Total	131	216	188			
Volume Left	59	0	32			
Volume Right	72	71	0			
cSH	676	1700	1281			
Volume to Capacity	0.19	0.13	0.02			
Queue Length 95th (ft)	18	0	2			
Control Delay (s)	11.6	0.0	1.5			
Lane LOS	B		A			
Approach Delay (s)	11.6	0.0	1.5			
Approach LOS	B					
Intersection Summary						
Average Delay			3.4			
Intersection Capacity Utilization			38.4%	ICU Level of Service		A
Analysis Period (min)			15			

Queues

10: Harwood St & US 26

5/2/2013

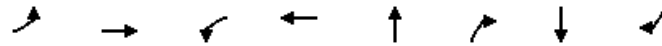

Lane Group	EBL	EBT	WBL	WBT	NBT	NBR	SBT	SBR
Lane Group Flow (vph)	49	715	33	516	108	49	114	60
v/c Ratio	0.10	0.67	0.08	0.53	0.45	0.13	0.42	0.19
Control Delay	5.4	16.2	5.5	14.1	32.7	3.1	31.2	5.1
Queue Delay	0.0	0.0	0.0	0.0	0.0	0.0	0.0	0.0
Total Delay	5.4	16.2	5.5	14.1	32.7	3.1	31.2	5.1
Queue Length 50th (ft)	6	139	4	141	33	0	34	0
Queue Length 95th (ft)	22	#541	17	316	110	11	113	20
Internal Link Dist (ft)		447		993	242		612	
Turn Bay Length (ft)	100		100			75		75
Base Capacity (vph)	580	1335	506	1294	372	515	417	449
Starvation Cap Reductn	0	0	0	0	0	0	0	0
Spillback Cap Reductn	0	0	0	0	0	0	0	0
Storage Cap Reductn	0	0	0	0	0	0	0	0
Reduced v/c Ratio	0.08	0.54	0.07	0.40	0.29	0.10	0.27	0.13





















Intersection Summary

95th percentile volume exceeds capacity, queue may be longer.
 Queue shown is maximum after two cycles.

HCM Signalized Intersection Capacity Analysis

10: Harwood St & US 26

5/2/2013

												
Movement	EBL	EBT	EBR	WBL	WBT	WBR	NBL	NBT	NBR	SBL	SBT	SBR
Lane Configurations												
Volume (vph)	45	638	20	30	409	65	60	40	45	60	45	55
Ideal Flow (vphpl)	1750	1750	1750	1750	1750	1750	1750	1750	1750	1750	1750	1750
Total Lost time (s)	5.0	5.0		5.0	5.0			5.0	5.0		5.0	5.0
Lane Util. Factor	1.00	1.00		1.00	1.00			1.00	1.00		1.00	1.00
Frpb, ped/bikes	1.00	1.00		1.00	1.00			1.00	0.97		1.00	0.97
Flpb, ped/bikes	1.00	1.00		1.00	1.00			1.00	1.00		1.00	1.00
Frt	1.00	1.00		1.00	0.98			1.00	0.85		1.00	0.85
Flt Protected	0.95	1.00		0.95	1.00			0.97	1.00		0.97	1.00
Satd. Flow (prot)	1524	1645		1538	1592			1523	1445		1675	1237
Flt Permitted	0.37	1.00		0.27	1.00			0.75	1.00		0.76	1.00
Satd. Flow (perm)	597	1645		436	1592			1177	1445		1316	1237
Peak-hour factor, PHF	0.92	0.92	0.92	0.92	0.92	0.92	0.92	0.92	0.92	0.92	0.92	0.92
Adj. Flow (vph)	49	693	22	33	445	71	65	43	49	65	49	60
RTOR Reduction (vph)	0	1	0	0	6	0	0	0	41	0	0	51
Lane Group Flow (vph)	49	714	0	33	510	0	0	108	8	0	114	9
Confl. Peds. (#/hr)	4		8	8		4	5		6	6		5
Heavy Vehicles (%)	9%	6%	0%	8%	8%	3%	2%	25%	0%	2%	0%	17%
Turn Type	pm+pt	NA		pm+pt	NA		Perm	NA	Perm	Perm	NA	Perm
Protected Phases	5	2		1	6			8			4	
Permitted Phases	2			6			8		8	4		4
Actuated Green, G (s)	39.6	36.4		36.6	34.9			9.9	9.9		9.9	9.9
Effective Green, g (s)	39.6	36.4		36.6	34.9			9.9	9.9		9.9	9.9
Actuated g/C Ratio	0.63	0.58		0.58	0.55			0.16	0.16		0.16	0.16
Clearance Time (s)	5.0	5.0		5.0	5.0			5.0	5.0		5.0	5.0
Vehicle Extension (s)	2.5	3.5		2.5	3.5			2.5	2.5		2.5	2.5
Lane Grp Cap (vph)	422	950		283	881			184	227		206	194
v/s Ratio Prot	c0.01	c0.43		0.00	0.32							
v/s Ratio Perm	0.07			0.06				c0.09	0.01		0.09	0.01
v/c Ratio	0.12	0.75		0.12	0.58			0.59	0.03		0.55	0.05
Uniform Delay, d1	5.0	9.9		6.7	9.2			24.7	22.5		24.5	22.6
Progression Factor	1.00	1.00		1.00	1.00			1.00	1.00		1.00	1.00
Incremental Delay, d2	0.1	3.5		0.1	1.0			3.9	0.0		2.6	0.1
Delay (s)	5.1	13.4		6.8	10.2			28.6	22.5		27.1	22.6
Level of Service	A	B		A	B			C	C		C	C
Approach Delay (s)		12.9			10.0			26.7			25.5	
Approach LOS		B			B			C			C	
Intersection Summary												
HCM 2000 Control Delay			14.6			HCM 2000 Level of Service				B		
HCM 2000 Volume to Capacity ratio			0.70									
Actuated Cycle Length (s)			63.0			Sum of lost time (s)			15.0			
Intersection Capacity Utilization			65.8%			ICU Level of Service			C			
Analysis Period (min)			15									
c Critical Lane Group												

Queues

11: Deer St & US 26

5/2/2013

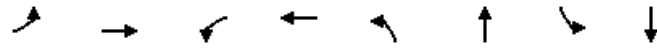





















Lane Group	EBL	EBT	WBL	WBT	NBL	NBT	SBL	SBT
Lane Group Flow (vph)	28	813	22	505	84	107	22	96
v/c Ratio	0.05	0.70	0.07	0.44	0.36	0.33	0.10	0.29
Control Delay	5.0	11.6	5.5	6.9	27.6	17.8	24.0	15.6
Queue Delay	0.0	0.0	0.0	0.0	0.0	0.0	0.0	0.0
Total Delay	5.0	11.6	5.5	6.9	27.6	17.8	24.0	15.6
Queue Length 50th (ft)	3	139	2	62	20	14	5	10
Queue Length 95th (ft)	15	426	13	190	85	75	31	63
Internal Link Dist (ft)		993		885		233		1851
Turn Bay Length (ft)	100		100		50		50	
Base Capacity (vph)	704	1580	416	1572	464	608	457	624
Starvation Cap Reductn	0	0	0	0	0	0	0	0
Spillback Cap Reductn	0	0	0	0	0	0	0	0
Storage Cap Reductn	0	0	0	0	0	0	0	0
Reduced v/c Ratio	0.04	0.51	0.05	0.32	0.18	0.18	0.05	0.15

Intersection Summary

HCM Signalized Intersection Capacity Analysis

11: Deer St & US 26

5/2/2013

												
Movement	EBL	EBT	EBR	WBL	WBT	WBR	NBL	NBT	NBR	SBL	SBT	SBR
Lane Configurations												
Volume (vph)	25	693	30	20	409	40	75	50	45	20	40	45
Ideal Flow (vphpl)	1750	1750	1750	1750	1750	1750	1750	1750	1750	1750	1750	1750
Total Lost time (s)	5.0	5.0		5.0	5.0		5.0	5.0		5.0	5.0	
Lane Util. Factor	1.00	1.00		1.00	1.00		1.00	1.00		1.00	1.00	
Frpb, ped/bikes	1.00	1.00		1.00	1.00		1.00	0.99		1.00	0.99	
Flpb, ped/bikes	1.00	1.00		1.00	1.00		1.00	1.00		0.99	1.00	
Frt	1.00	0.99		1.00	0.99		1.00	0.93		1.00	0.92	
Flt Protected	0.95	1.00		0.95	1.00		0.95	1.00		0.95	1.00	
Satd. Flow (prot)	1592	1686		1655	1676		1655	1511		1650	1543	
Flt Permitted	0.45	1.00		0.25	1.00		0.69	1.00		0.69	1.00	
Satd. Flow (perm)	753	1686		444	1676		1211	1511		1195	1543	
Peak-hour factor, PHF	0.89	0.89	0.89	0.89	0.89	0.89	0.89	0.89	0.89	0.89	0.89	0.89
Adj. Flow (vph)	28	779	34	22	460	45	84	56	51	22	45	51
RTOR Reduction (vph)	0	2	0	0	4	0	0	38	0	0	43	0
Lane Group Flow (vph)	28	811	0	22	501	0	84	69	0	22	53	0
Confl. Peds. (#/hr)	7		14	14		7	4		7	7		4
Heavy Vehicles (%)	4%	3%	3%	0%	3%	0%	0%	7%	5%	0%	3%	3%
Turn Type	Perm	NA		Perm	NA		Perm	NA		Perm	NA	
Protected Phases		2			6			8				4
Permitted Phases	2			6			8			4		
Actuated Green, G (s)	34.2	34.2		34.2	34.2		8.1	8.1		8.1	8.1	
Effective Green, g (s)	34.2	34.2		34.2	34.2		8.1	8.1		8.1	8.1	
Actuated g/C Ratio	0.65	0.65		0.65	0.65		0.15	0.15		0.15	0.15	
Clearance Time (s)	5.0	5.0		5.0	5.0		5.0	5.0		5.0	5.0	
Vehicle Extension (s)	3.0	3.0		3.0	3.0		2.5	2.5		2.5	2.5	
Lane Grp Cap (vph)	492	1102		290	1095		187	234		185	238	
v/s Ratio Prot		c0.48			0.30			0.05				0.03
v/s Ratio Perm	0.04			0.05			c0.07			0.02		
v/c Ratio	0.06	0.74		0.08	0.46		0.45	0.29		0.12	0.22	
Uniform Delay, d1	3.3	6.0		3.3	4.5		20.1	19.6		19.0	19.3	
Progression Factor	1.00	1.00		1.00	1.00		1.00	1.00		1.00	1.00	
Incremental Delay, d2	0.0	2.6		0.1	0.3		1.2	0.5		0.2	0.3	
Delay (s)	3.3	8.6		3.4	4.8		21.3	20.1		19.2	19.7	
Level of Service	A	A		A	A		C	C		B	B	
Approach Delay (s)		8.5			4.7			20.6			19.6	
Approach LOS		A			A			C			B	
Intersection Summary												
HCM 2000 Control Delay			9.4				HCM 2000 Level of Service			A		
HCM 2000 Volume to Capacity ratio			0.68									
Actuated Cycle Length (s)			52.3				Sum of lost time (s)			10.0		
Intersection Capacity Utilization			62.5%				ICU Level of Service			B		
Analysis Period (min)			15									
c Critical Lane Group												

Queues

12: Main St & US 26

5/2/2013

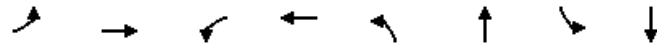

Lane Group	EBL	EBT	WBL	WBT	NBL	NBT	SBL	SBT
Lane Group Flow (vph)	133	690	106	483	149	303	101	298
v/c Ratio	0.38	0.94	0.45	0.72	0.72	0.78	0.47	0.86
Control Delay	12.7	47.3	16.0	28.0	46.7	47.9	31.0	56.8
Queue Delay	0.0	0.0	0.0	0.0	0.0	0.0	0.0	0.0
Total Delay	12.7	47.3	16.0	28.0	46.7	47.9	31.0	56.8
Queue Length 50th (ft)	33	358	25	208	64	167	42	163
Queue Length 95th (ft)	68	#690	56	372	#151	#310	85	#299
Internal Link Dist (ft)		885		1205		239		251
Turn Bay Length (ft)	100		100		75		75	
Base Capacity (vph)	386	747	291	740	208	389	216	361
Starvation Cap Reductn	0	0	0	0	0	0	0	0
Spillback Cap Reductn	0	0	0	0	0	0	0	0
Storage Cap Reductn	0	0	0	0	0	0	0	0
Reduced v/c Ratio	0.34	0.92	0.36	0.65	0.72	0.78	0.47	0.83





















Intersection Summary

95th percentile volume exceeds capacity, queue may be longer.
 Queue shown is maximum after two cycles.

HCM Signalized Intersection Capacity Analysis

12: Main St & US 26

5/2/2013

												
Movement	EBL	EBT	EBR	WBL	WBT	WBR	NBL	NBT	NBR	SBL	SBT	SBR
Lane Configurations												
Volume (vph)	125	483	165	100	349	105	140	240	45	95	240	40
Ideal Flow (vphpl)	1750	1750	1750	1750	1750	1750	1750	1750	1750	1750	1750	1750
Total Lost time (s)	5.0	5.0		5.0	5.0		5.0	5.0		5.0	5.0	
Lane Util. Factor	1.00	1.00		1.00	1.00		1.00	1.00		1.00	1.00	
Frbp, ped/bikes	1.00	0.99		1.00	0.99		1.00	0.99		1.00	1.00	
Flpb, ped/bikes	1.00	1.00		1.00	1.00		1.00	1.00		1.00	1.00	
Frt	1.00	0.96		1.00	0.97		1.00	0.98		1.00	0.98	
Flt Protected	0.95	1.00		0.95	1.00		0.95	1.00		0.95	1.00	
Satd. Flow (prot)	1596	1623		1662	1612		1646	1635		1609	1669	
Flt Permitted	0.28	1.00		0.13	1.00		0.29	1.00		0.35	1.00	
Satd. Flow (perm)	478	1623		232	1612		503	1635		591	1669	
Peak-hour factor, PHF	0.94	0.94	0.94	0.94	0.94	0.94	0.94	0.94	0.94	0.94	0.94	0.94
Adj. Flow (vph)	133	514	176	106	371	112	149	255	48	101	255	43
RTOR Reduction (vph)	0	14	0	0	12	0	0	7	0	0	6	0
Lane Group Flow (vph)	133	676	0	106	471	0	149	296	0	101	292	0
Confl. Peds. (#/hr)	11		4	4		11			9	9		
Heavy Vehicles (%)	4%	4%	0%	0%	4%	3%	1%	4%	3%	3%	2%	6%
Turn Type	pm+pt	NA		pm+pt	NA		pm+pt	NA		pm+pt	NA	
Protected Phases	5	2		1	6		3	8		7	4	
Permitted Phases	2			6			8			4		
Actuated Green, G (s)	45.3	37.6		41.7	35.8		25.0	19.9		22.4	18.6	
Effective Green, g (s)	45.3	37.6		41.7	35.8		25.0	19.9		22.4	18.6	
Actuated g/C Ratio	0.52	0.43		0.48	0.41		0.29	0.23		0.26	0.21	
Clearance Time (s)	5.0	5.0		5.0	5.0		5.0	5.0		5.0	5.0	
Vehicle Extension (s)	2.0	3.0		2.0	4.0		2.0	2.0		2.0	2.0	
Lane Grp Cap (vph)	347	699		207	661		211	373		196	356	
v/s Ratio Prot	0.03	c0.42		c0.03	0.29		c0.04	c0.18		0.02	0.17	
v/s Ratio Perm	0.17			0.21			0.16			0.11		
v/c Ratio	0.38	0.97		0.51	0.71		0.71	0.79		0.52	0.82	
Uniform Delay, d1	12.7	24.2		16.6	21.4		26.6	31.7		26.8	32.7	
Progression Factor	1.00	1.00		1.00	1.00		1.00	1.00		1.00	1.00	
Incremental Delay, d2	0.3	25.9		0.9	3.9		8.5	10.4		1.0	13.0	
Delay (s)	12.9	50.1		17.5	25.3		35.0	42.1		27.8	45.7	
Level of Service	B	D		B	C		D	D		C	D	
Approach Delay (s)		44.1			23.9			39.8			41.2	
Approach LOS		D			C			D			D	
Intersection Summary												
HCM 2000 Control Delay			37.5			HCM 2000 Level of Service				D		
HCM 2000 Volume to Capacity ratio			0.87									
Actuated Cycle Length (s)			87.2			Sum of lost time (s)			20.0			
Intersection Capacity Utilization			86.1%			ICU Level of Service			E			
Analysis Period (min)			15									
c Critical Lane Group												

Queues
13: Elm St & US 26

5/2/2013

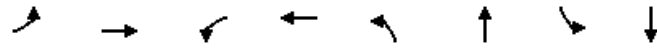





















Lane Group	EBL	EBT	WBL	WBT	NBL	NBT	SBL	SBT
Lane Group Flow (vph)	11	666	11	549	34	79	96	45
v/c Ratio	0.03	0.61	0.03	0.50	0.14	0.22	0.37	0.12
Control Delay	5.9	10.6	6.0	8.9	18.3	10.5	21.6	13.3
Queue Delay	0.0	0.0	0.0	0.0	0.0	0.0	0.0	0.0
Total Delay	5.9	10.6	6.0	8.9	18.3	10.5	21.6	13.3
Queue Length 50th (ft)	1	98	1	72	7	5	20	5
Queue Length 95th (ft)	9	311	9	230	33	40	73	32
Internal Link Dist (ft)		1205		1506		316		433
Turn Bay Length (ft)	75		75		50		50	
Base Capacity (vph)	587	1649	552	1638	531	733	560	764
Starvation Cap Reductn	0	0	0	0	0	0	0	0
Spillback Cap Reductn	0	0	0	0	0	0	0	0
Storage Cap Reductn	0	0	0	0	0	0	0	0
Reduced v/c Ratio	0.02	0.40	0.02	0.34	0.06	0.11	0.17	0.06

Intersection Summary

HCM Signalized Intersection Capacity Analysis

13: Elm St & US 26

5/2/2013

													
Movement	EBL	EBT	EBR	WBL	WBT	WBR	NBL	NBT	NBR	SBL	SBT	SBR	
Lane Configurations													
Volume (vph)	10	578	15	10	479	10	30	25	45	85	25	15	
Ideal Flow (vphpl)	1750	1750	1750	1750	1750	1750	1750	1750	1750	1750	1750	1750	
Total Lost time (s)	5.0	5.0		5.0	5.0		5.0	5.0		5.0	5.0		
Lane Util. Factor	1.00	1.00		1.00	1.00		1.00	1.00		1.00	1.00		
Frbp, ped/bikes	1.00	1.00		1.00	1.00		1.00	0.98		1.00	0.99		
Flpb, ped/bikes	1.00	1.00		1.00	1.00		0.99	1.00		0.99	1.00		
Frt	1.00	1.00		1.00	1.00		1.00	0.90		1.00	0.94		
Flt Protected	0.95	1.00		0.95	1.00		0.95	1.00		0.95	1.00		
Satd. Flow (prot)	1414	1705		1659	1694		1506	1524		1633	1629		
Flt Permitted	0.41	1.00		0.33	1.00		0.73	1.00		0.71	1.00		
Satd. Flow (perm)	609	1705		571	1694		1154	1524		1213	1629		
Peak-hour factor, PHF	0.89	0.89	0.89	0.89	0.89	0.89	0.89	0.89	0.89	0.89	0.89	0.89	
Adj. Flow (vph)	11	649	17	11	538	11	34	28	51	96	28	17	
RTOR Reduction (vph)	0	1	0	0	1	0	0	42	0	0	14	0	
Lane Group Flow (vph)	11	665	0	11	548	0	34	37	0	96	31	0	
Confl. Peds. (#/hr)	10		5	5		10	12		8	8		12	
Confl. Bikes (#/hr)													1
Heavy Vehicles (%)	17%	2%	9%	0%	3%	0%	9%	5%	0%	1%	0%	0%	
Turn Type	Perm	NA		Perm	NA		Perm	NA		Perm	NA		
Protected Phases		2			6			8				4	
Permitted Phases	2			6			8			4			
Actuated Green, G (s)	27.6	27.6		27.6	27.6		8.2	8.2		8.2	8.2		
Effective Green, g (s)	27.6	27.6		27.6	27.6		8.2	8.2		8.2	8.2		
Actuated g/C Ratio	0.60	0.60		0.60	0.60		0.18	0.18		0.18	0.18		
Clearance Time (s)	5.0	5.0		5.0	5.0		5.0	5.0		5.0	5.0		
Vehicle Extension (s)	3.5	3.5		3.5	3.5		2.5	2.5		2.5	2.5		
Lane Grp Cap (vph)	366	1027		344	1020		206	272		217	291		
v/s Ratio Prot		c0.39			0.32			0.02				0.02	
v/s Ratio Perm	0.02			0.02			0.03			c0.08			
v/c Ratio	0.03	0.65		0.03	0.54		0.17	0.14		0.44	0.11		
Uniform Delay, d1	3.7	5.9		3.7	5.3		15.9	15.8		16.8	15.7		
Progression Factor	1.00	1.00		1.00	1.00		1.00	1.00		1.00	1.00		
Incremental Delay, d2	0.0	1.5		0.0	0.6		0.3	0.2		1.0	0.1		
Delay (s)	3.7	7.4		3.7	6.0		16.2	16.0		17.8	15.9		
Level of Service	A	A		A	A		B	B		B	B		
Approach Delay (s)		7.3			5.9			16.0			17.2		
Approach LOS		A			A			B			B		

Intersection Summary



















HCM 2000 Control Delay	8.4	HCM 2000 Level of Service	A
HCM 2000 Volume to Capacity ratio	0.60		
Actuated Cycle Length (s)	45.8	Sum of lost time (s)	10.0
Intersection Capacity Utilization	56.0%	ICU Level of Service	B
Analysis Period (min)	15		

c Critical Lane Group

HCM Unsignalized Intersection Capacity Analysis

14: Juniper St & US 26

5/2/2013

												
Movement	EBL	EBT	EBR	WBL	WBT	WBR	NBL	NBT	NBR	SBL	SBT	SBR
Lane Configurations												
Volume (veh/h)	65	693	5	5	484	25	5	5	5	35	5	40
Sign Control	Free			Free				Stop			Stop	
Grade	0%			0%				0%			0%	
Peak Hour Factor	0.90	0.90	0.90	0.90	0.90	0.90	0.90	0.90	0.90	0.90	0.90	0.90
Hourly flow rate (vph)	72	770	6	6	538	28	6	6	6	39	6	44
Pedestrians		1			10			10			8	
Lane Width (ft)		12.0			12.0			12.0			12.0	
Walking Speed (ft/s)		4.0			4.0			4.0			4.0	
Percent Blockage		0			1			1			1	
Right turn flare (veh)												
Median type	TWLTL				TWLTL							
Median storage (veh)	2				2							
Upstream signal (ft)												
pX, platoon unblocked												
vC, conflicting volume	574			786			1524	1512	793	1504	1501	561
vC1, stage 1 conf vol							927	927		571	571	
vC2, stage 2 conf vol							597	585		933	930	
vCu, unblocked vol	574			786			1524	1512	793	1504	1501	561
tC, single (s)	4.1			4.1			7.1	6.5	6.2	7.2	6.8	6.2
tC, 2 stage (s)							6.1	5.5		6.2	5.8	
tF (s)	2.2			2.2			3.5	4.0	3.3	3.6	4.3	3.3
p0 queue free %	93			99			98	98	99	83	98	92
cM capacity (veh/h)	988			835			239	269	385	235	244	527
Direction, Lane #	EB 1	EB 2	WB 1	WB 2	NB 1	SB 1						
Volume Total	72	776	6	566	17	89						
Volume Left	72	0	6	0	6	39						
Volume Right	0	6	0	28	6	44						
cSH	988	1700	835	1700	286	326						
Volume to Capacity	0.07	0.46	0.01	0.33	0.06	0.27						
Queue Length 95th (ft)	6	0	1	0	5	28						
Control Delay (s)	8.9	0.0	9.3	0.0	18.4	20.1						
Lane LOS	A		A		C	C						
Approach Delay (s)	0.8		0.1		18.4	20.1						
Approach LOS					C	C						
Intersection Summary												
Average Delay			1.8									
Intersection Capacity Utilization			61.0%		ICU Level of Service				B			
Analysis Period (min)			15									

HCM Unsignalized Intersection Capacity Analysis
 15: Knowledge St & US 26

5/2/2013



Movement	EBT	EBR	WBL	WBT	NBL	NBR
Lane Configurations	↻		↻	↻	↻	↻
Volume (veh/h)	548	5	5	629	5	5
Sign Control	Free			Free	Stop	
Grade	0%			0%	0%	
Peak Hour Factor	0.91	0.91	0.91	0.91	0.91	0.91
Hourly flow rate (vph)	602	5	5	691	5	5
Pedestrians					6	
Lane Width (ft)					12.0	
Walking Speed (ft/s)					4.0	
Percent Blockage					1	
Right turn flare (veh)						
Median type	TWLTL			TWLTL		
Median storage (veh)	2			2		
Upstream signal (ft)						
pX, platoon unblocked						
vC, conflicting volume			614		1313	611
vC1, stage 1 conf vol					611	
vC2, stage 2 conf vol					702	
vCu, unblocked vol			614		1313	611
tC, single (s)			4.1		6.4	6.2
tC, 2 stage (s)					5.4	
tF (s)			2.2		3.5	3.3
p0 queue free %			99		99	99
cM capacity (veh/h)			971		392	495
Direction, Lane #	EB 1	WB 1	WB 2	NB 1		
Volume Total	608	5	691	11		
Volume Left	0	5	0	5		
Volume Right	5	0	0	5		
cSH	1700	971	1700	438		
Volume to Capacity	0.36	0.01	0.41	0.03		
Queue Length 95th (ft)	0	0	0	2		
Control Delay (s)	0.0	8.7	0.0	13.4		
Lane LOS		A		B		
Approach Delay (s)	0.0	0.1		13.4		
Approach LOS				B		
Intersection Summary						
Average Delay			0.1			
Intersection Capacity Utilization			45.9%		ICU Level of Service	A
Analysis Period (min)			15			

Queues

16: Combs Flat Rd & US 26

5/2/2013



Lane Group	EBL	EBT	WBL	WBT	NBT	SBT
Lane Group Flow (vph)	101	509	85	392	377	287
v/c Ratio	0.57	0.81	0.50	0.61	0.78	0.54
Control Delay	51.6	31.8	48.5	23.5	40.8	28.8
Queue Delay	0.0	0.0	0.0	0.0	0.0	0.0
Total Delay	51.6	31.8	48.5	23.5	40.8	28.8
Queue Length 50th (ft)	52	227	43	163	181	122
Queue Length 95th (ft)	#136	355	105	250	#441	259
Internal Link Dist (ft)		1816		4182	3042	696
Turn Bay Length (ft)	100		150			
Base Capacity (vph)	209	1189	209	1242	481	536
Starvation Cap Reductn	0	0	0	0	0	0
Spillback Cap Reductn	0	0	0	0	0	0
Storage Cap Reductn	0	0	0	0	0	0
Reduced v/c Ratio	0.48	0.43	0.41	0.32	0.78	0.54



















Intersection Summary

95th percentile volume exceeds capacity, queue may be longer.
 Queue shown is maximum after two cycles.

HCM Signalized Intersection Capacity Analysis

16: Combs Flat Rd & US 26

5/2/2013

													
Movement	EBL	EBT	EBR	WBL	WBT	WBR	NBL	NBT	NBR	SBL	SBT	SBR	
Lane Configurations													
Volume (vph)	95	323	155	80	299	70	85	205	65	40	180	50	
Ideal Flow (vphpl)	1750	1750	1750	1750	1750	1750	1750	1750	1750	1750	1750	1750	
Total Lost time (s)	5.0	5.0		5.0	5.0			5.0			5.0		
Lane Util. Factor	1.00	1.00		1.00	1.00			1.00			1.00		
Frbp, ped/bikes	1.00	0.99		1.00	1.00			1.00			1.00		
Flpb, ped/bikes	1.00	1.00		1.00	1.00			1.00			1.00		
Frt	1.00	0.95		1.00	0.97			0.98			0.98		
Flt Protected	0.95	1.00		0.95	1.00			0.99			0.99		
Satd. Flow (prot)	1599	1589		1599	1665			1604			1644		
Flt Permitted	0.95	1.00		0.95	1.00			0.83			0.91		
Satd. Flow (perm)	1599	1589		1599	1665			1345			1501		
Peak-hour factor, PHF	0.94	0.94	0.94	0.94	0.94	0.94	0.94	0.94	0.94	0.94	0.94	0.94	
Adj. Flow (vph)	101	344	165	85	318	74	90	218	69	43	191	53	
RTOR Reduction (vph)	0	20	0	0	10	0	0	6	0	0	6	0	
Lane Group Flow (vph)	101	489	0	85	382	0	0	371	0	0	281	0	
Confl. Peds. (#/hr)	2		1	1		2	3					3	
Confl. Bikes (#/hr)			1			2			1				
Heavy Vehicles (%)	4%	4%	4%	4%	2%	0%	10%	4%	0%	3%	2%	4%	
Turn Type	Prot	NA		Prot	NA		Perm	NA		Perm	NA		
Protected Phases	5	2		1	6			8				4	
Permitted Phases							8			4			
Actuated Green, G (s)	7.1	30.5		6.8	30.2			28.2			28.2		
Effective Green, g (s)	7.1	30.5		6.8	30.2			28.2			28.2		
Actuated g/C Ratio	0.09	0.38		0.08	0.38			0.35			0.35		
Clearance Time (s)	5.0	5.0		5.0	5.0			5.0			5.0		
Vehicle Extension (s)	2.0	4.5		2.5	4.5			2.8			2.8		
Lane Grp Cap (vph)	141	602		135	624			471			525		
v/s Ratio Prot	c0.06	c0.31		0.05	0.23								
v/s Ratio Perm								c0.28			0.19		
v/c Ratio	0.72	0.81		0.63	0.61			0.79			0.53		
Uniform Delay, d1	35.7	22.4		35.6	20.4			23.5			20.9		
Progression Factor	1.00	1.00		1.00	1.00			1.00			1.00		
Incremental Delay, d2	13.4	9.0		7.7	2.3			8.3			1.0		
Delay (s)	49.1	31.4		43.3	22.7			31.8			21.9		
Level of Service	D	C		D	C			C			C		
Approach Delay (s)		34.3			26.4			31.8			21.9		
Approach LOS		C			C			C			C		



















Intersection Summary

HCM 2000 Control Delay	29.6	HCM 2000 Level of Service	C
HCM 2000 Volume to Capacity ratio	0.79		
Actuated Cycle Length (s)	80.5	Sum of lost time (s)	15.0
Intersection Capacity Utilization	80.1%	ICU Level of Service	D
Analysis Period (min)	15		

c Critical Lane Group

HCM Unsignalized Intersection Capacity Analysis
 17: Laughlin Rd & US 26

















5/2/2013

												
Movement	EBL	EBT	EBR	WBL	WBT	WBR	NBL	NBT	NBR	SBL	SBT	SBR
Lane Configurations												
Volume (veh/h)	5	198	25	5	144	56	25	10	5	30	17	10
Sign Control		Free			Free			Stop			Stop	
Grade		0%			0%			0%			0%	
Peak Hour Factor	0.89	0.89	0.89	0.89	0.89	0.89	0.89	0.89	0.89	0.89	0.89	0.89
Hourly flow rate (vph)	6	222	28	6	162	63	28	11	6	34	19	11
Pedestrians												1
Lane Width (ft)												12.0
Walking Speed (ft/s)												4.0
Percent Blockage												0
Right turn flare (veh)												
Median type		TWLTL			None							
Median storage (veh)		2										
Upstream signal (ft)												
pX, platoon unblocked												
vC, conflicting volume	163			251			442	422	237	450	467	194
vC1, stage 1 conf vol							248	248		205	205	
vC2, stage 2 conf vol							194	174		245	262	
vCu, unblocked vol	163			251			442	422	237	450	467	194
tC, single (s)	4.1			4.1			7.1	6.5	6.2	7.2	6.5	6.2
tC, 2 stage (s)							6.1	5.5		6.2	5.5	
tF (s)	2.2			2.2			3.5	4.0	3.3	3.6	4.0	3.3
p0 queue free %	100			100			96	98	99	95	97	99
cM capacity (veh/h)	1427			1327			663	640	807	634	620	852
Direction, Lane #	EB 1	EB 2	WB 1	WB 2	NB 1	SB 1						
Volume Total	6	251	6	225	45	64						
Volume Left	6	0	6	0	28	34						
Volume Right	0	28	0	63	6	11						
cSH	1427	1700	1327	1700	672	659						
Volume to Capacity	0.00	0.15	0.00	0.13	0.07	0.10						
Queue Length 95th (ft)	0	0	0	0	6	8						
Control Delay (s)	7.5	0.0	7.7	0.0	10.7	11.0						
Lane LOS	A		A		B	B						
Approach Delay (s)	0.2		0.2		10.7	11.0						
Approach LOS					B	B						
Intersection Summary												
Average Delay			2.1									
Intersection Capacity Utilization			23.5%		ICU Level of Service					A		
Analysis Period (min)			15									

HCM Unsignalized Intersection Capacity Analysis

18: Meadow Lakes Dr & 2nd St



















5/2/2013

												
Movement	EBL	EBT	EBR	WBL	WBT	WBR	NBL	NBT	NBR	SBL	SBT	SBR
Lane Configurations												
Volume (veh/h)	10	255	25	35	20	15	5	25	40	15	20	15
Sign Control		Free			Free			Stop			Stop	
Grade		0%			0%			0%			0%	
Peak Hour Factor	0.83	0.83	0.83	0.83	0.83	0.83	0.83	0.83	0.83	0.83	0.83	0.83
Hourly flow rate (vph)	12	307	30	42	24	18	6	30	48	18	24	18
Pedestrians		10						1			6	
Lane Width (ft)		12.0						12.0			12.0	
Walking Speed (ft/s)		4.0						4.0			4.0	
Percent Blockage		1						0			1	
Right turn flare (veh)												
Median type		None			None							
Median storage (veh)												
Upstream signal (ft)												
pX, platoon unblocked												
vC, conflicting volume	48			338			505	480	323	533	486	49
vC1, stage 1 conf vol												
vC2, stage 2 conf vol												
vCu, unblocked vol	48			338			505	480	323	533	486	49
tC, single (s)	4.1			4.1			7.1	6.5	6.2	7.2	6.5	6.3
tC, 2 stage (s)												
tF (s)	2.2			2.2			3.5	4.0	3.3	3.6	4.0	3.4
p0 queue free %	99			97			99	94	93	95	95	98
cM capacity (veh/h)	1564			1214			433	465	715	381	461	973
Direction, Lane #	EB 1	WB 1	NB 1	SB 1								
Volume Total	349	84	84	60								
Volume Left	12	42	6	18								
Volume Right	30	18	48	18								
cSH	1564	1214	577	509								
Volume to Capacity	0.01	0.03	0.15	0.12								
Queue Length 95th (ft)	1	3	13	10								
Control Delay (s)	0.3	4.2	12.3	13.0								
Lane LOS	A	A	B	B								
Approach Delay (s)	0.3	4.2	12.3	13.0								
Approach LOS			B	B								
Intersection Summary												
Average Delay			4.0									
Intersection Capacity Utilization			39.2%		ICU Level of Service				A			
Analysis Period (min)			15									

HCM Unsignalized Intersection Capacity Analysis

19: Deer St & 2nd St



















5/2/2013

												
Movement	EBL	EBT	EBR	WBL	WBT	WBR	NBL	NBT	NBR	SBL	SBT	SBR
Lane Configurations												
Volume (veh/h)	35	135	90	10	65	55	35	70	10	20	60	15
Sign Control		Stop			Stop			Free			Free	
Grade		0%			0%			0%			0%	
Peak Hour Factor	0.84	0.84	0.84	0.84	0.84	0.84	0.84	0.84	0.84	0.84	0.84	0.84
Hourly flow rate (vph)	42	161	107	12	77	65	42	83	12	24	71	18
Pedestrians		4			7			2			1	
Lane Width (ft)		12.0			12.0			12.0			12.0	
Walking Speed (ft/s)		4.0			4.0			4.0			4.0	
Percent Blockage		0			1			0			0	
Right turn flare (veh)												
Median type								None			None	
Median storage (veh)												
Upstream signal (ft)											313	
pX, platoon unblocked												
vC, conflicting volume	404	318	86	488	321	97	93			102		
vC1, stage 1 conf vol												
vC2, stage 2 conf vol												
vCu, unblocked vol	404	318	86	488	321	97	93			102		
tC, single (s)	7.1	6.5	6.2	7.1	6.5	6.2	4.1			4.2		
tC, 2 stage (s)												
tF (s)	3.5	4.0	3.3	3.5	4.0	3.3	2.2			2.3		
p0 queue free %	91	72	89	96	86	93	97			98		
cM capacity (veh/h)	442	569	970	327	568	952	1490			1427		
Direction, Lane #	EB 1	WB 1	NB 1	NB 2	SB 1	SB 2						
Volume Total	310	155	42	95	24	89						
Volume Left	42	12	42	0	24	0						
Volume Right	107	65	0	12	0	18						
cSH	635	641	1490	1700	1427	1700						
Volume to Capacity	0.49	0.24	0.03	0.06	0.02	0.05						
Queue Length 95th (ft)	70	24	2	0	1	0						
Control Delay (s)	15.9	12.4	7.5	0.0	7.6	0.0						
Lane LOS	C	B	A		A							
Approach Delay (s)	15.9	12.4	2.3		1.6							
Approach LOS	C	B										
Intersection Summary												
Average Delay			10.3									
Intersection Capacity Utilization			38.9%		ICU Level of Service					A		
Analysis Period (min)			15									

HCM Unsignalized Intersection Capacity Analysis

20: Main St & 2nd St N

5/2/2013

												
Movement	EBL	EBT	EBR	WBL	WBT	WBR	NBL	NBT	NBR	SBL	SBT	SBR
Lane Configurations												
Volume (veh/h)	45	25	100	5	20	55	75	320	10	30	380	60
Sign Control		Stop			Stop			Free			Free	
Grade		0%			0%			0%			0%	
Peak Hour Factor	0.90	0.90	0.90	0.90	0.90	0.90	0.90	0.90	0.90	0.90	0.90	0.90
Hourly flow rate (vph)	50	28	111	6	22	61	83	356	11	33	422	67
Pedestrians		11			5			2			11	
Lane Width (ft)		12.0			12.0			12.0			12.0	
Walking Speed (ft/s)		4.0			4.0			4.0			4.0	
Percent Blockage		1			0			0			1	
Right turn flare (veh)												
Median type								None			None	
Median storage (veh)												
Upstream signal (ft)												319
pX, platoon unblocked	0.86	0.86	0.86	0.86	0.86		0.86					
vC, conflicting volume	1139	1072	469	1149	1099	377	500			372		
vC1, stage 1 conf vol												
vC2, stage 2 conf vol												
vCu, unblocked vol	1081	1003	304	1093	1035	377	340			372		
tC, single (s)	7.1	6.5	6.2	7.1	6.5	6.2	4.1			4.1		
tC, 2 stage (s)												
tF (s)	3.5	4.0	3.3	3.5	4.0	3.3	2.2			2.2		
p0 queue free %	60	85	82	95	87	91	92			97		
cM capacity (veh/h)	125	186	630	110	174	665	1051			1193		
Direction, Lane #	EB 1	WB 1	NB 1	NB 2	SB 1	SB 2						
Volume Total	189	89	83	367	33	489						
Volume Left	50	6	83	0	33	0						
Volume Right	111	61	0	11	0	67						
cSH	260	330	1051	1700	1193	1700						
Volume to Capacity	0.73	0.27	0.08	0.22	0.03	0.29						
Queue Length 95th (ft)	132	28	7	0	2	0						
Control Delay (s)	48.5	19.9	8.7	0.0	8.1	0.0						
Lane LOS	E	C	A		A							
Approach Delay (s)	48.5	19.9	1.6		0.5							
Approach LOS	E	C										
Intersection Summary												
Average Delay			9.5									
Intersection Capacity Utilization			57.9%		ICU Level of Service					B		
Analysis Period (min)			15									

HCM Unsignalized Intersection Capacity Analysis

21: Main St & 5th St

5/2/2013



















Movement	WBL	WBR	NBT	NBR	SBL	SBT
Lane Configurations	Y		T			T
Volume (veh/h)	5	40	220	5	45	420
Sign Control	Stop		Free			Free
Grade	0%		0%			0%
Peak Hour Factor	0.92	0.92	0.92	0.92	0.92	0.92
Hourly flow rate (vph)	5	43	239	5	49	457
Pedestrians	3					
Lane Width (ft)	12.0					
Walking Speed (ft/s)	4.0					
Percent Blockage	0					
Right turn flare (veh)						
Median type			None			None
Median storage (veh)						
Upstream signal (ft)						
pX, platoon unblocked						
vC, conflicting volume	799	245			248	
vC1, stage 1 conf vol						
vC2, stage 2 conf vol						
vCu, unblocked vol	799	245			248	
tC, single (s)	6.4	6.2			4.1	
tC, 2 stage (s)						
tF (s)	3.5	3.3			2.2	
p0 queue free %	98	94			96	
cM capacity (veh/h)	343	789			1298	
Direction, Lane #	WB 1	NB 1	SB 1			
Volume Total	49	245	505			
Volume Left	5	0	49			
Volume Right	43	5	0			
cSH	690	1700	1298			
Volume to Capacity	0.07	0.14	0.04			
Queue Length 95th (ft)	6	0	3			
Control Delay (s)	10.6	0.0	1.1			
Lane LOS	B		A			
Approach Delay (s)	10.6	0.0	1.1			
Approach LOS	B					
Intersection Summary						
Average Delay			1.4			
Intersection Capacity Utilization			53.0%	ICU Level of Service		A
Analysis Period (min)			15			

HCM Unsignalized Intersection Capacity Analysis

22: Main St & Lynn Blvd

5/2/2013

												
Movement	EBL	EBT	EBR	WBL	WBT	WBR	NBL	NBT	NBR	SBL	SBT	SBR
Lane Configurations												
Volume (veh/h)	35	15	20	60	5	250	5	50	30	270	115	5
Sign Control		Stop			Stop			Free			Free	
Grade		0%			0%			0%			0%	
Peak Hour Factor	0.74	0.74	0.74	0.74	0.74	0.74	0.74	0.74	0.74	0.74	0.74	0.74
Hourly flow rate (vph)	47	20	27	81	7	338	7	68	41	365	155	7
Pedestrians								4			1	
Lane Width (ft)								12.0			12.0	
Walking Speed (ft/s)								4.0			4.0	
Percent Blockage								0			0	
Right turn flare (veh)												
Median type								None			None	
Median storage (veh)												
Upstream signal (ft)												
pX, platoon unblocked												
vC, conflicting volume	1332	1010	163	1028	993	89	162			108		
vC1, stage 1 conf vol												
vC2, stage 2 conf vol												
vCu, unblocked vol	1332	1010	163	1028	993	89	162			108		
tC, single (s)	7.1	6.5	6.2	7.2	6.5	6.3	5.1			4.1		
tC, 2 stage (s)												
tF (s)	3.5	4.0	3.3	3.6	4.0	3.4	3.1			2.2		
p0 queue free %	30	89	97	44	96	65	99			75		
cM capacity (veh/h)	67	181	884	144	185	955	989			1489		
Direction, Lane #	EB 1	WB 1	NB 1	SB 1	SB 2							
Volume Total	95	426	115	365	162							
Volume Left	47	81	7	365	0							
Volume Right	27	338	41	0	7							
cSH	112	447	989	1489	1700							
Volume to Capacity	0.85	0.95	0.01	0.25	0.10							
Queue Length 95th (ft)	129	295	1	25	0							
Control Delay (s)	118.5	61.9	0.6	8.2	0.0							
Lane LOS	F	F	A	A								
Approach Delay (s)	118.5	61.9	0.6	5.7								
Approach LOS	F	F										
Intersection Summary												
Average Delay				34.9								
Intersection Capacity Utilization			51.0%		ICU Level of Service					A		
Analysis Period (min)			15									

HCM Unsignalized Intersection Capacity Analysis

23: Lynn Blvd & Fairview St

5/2/2013



Movement	EBL	EBT	WBT	WBR	SBL	SBR
Lane Configurations		↔	↔		↔	
Volume (veh/h)	20	315	250	20	50	25
Sign Control		Free	Free		Stop	
Grade		0%	0%		0%	
Peak Hour Factor	0.65	0.65	0.65	0.65	0.65	0.65
Hourly flow rate (vph)	31	485	385	31	77	38
Pedestrians						
Lane Width (ft)						
Walking Speed (ft/s)						
Percent Blockage						
Right turn flare (veh)						
Median type		None	None			
Median storage (veh)						
Upstream signal (ft)						
pX, platoon unblocked						
vC, conflicting volume	415				946	400
vC1, stage 1 conf vol						
vC2, stage 2 conf vol						
vCu, unblocked vol	415				946	400
tC, single (s)	4.1				6.7	6.2
tC, 2 stage (s)						
tF (s)	2.2				3.7	3.3
p0 queue free %	97				70	94
cM capacity (veh/h)	1154				256	654
Direction, Lane #	EB 1	WB 1	SB 1			
Volume Total	515	415	115			
Volume Left	31	0	77			
Volume Right	0	31	38			
cSH	1154	1700	321			
Volume to Capacity	0.03	0.24	0.36			
Queue Length 95th (ft)	2	0	41			
Control Delay (s)	0.8	0.0	22.4			
Lane LOS	A		C			
Approach Delay (s)	0.8	0.0	22.4			
Approach LOS			C			
Intersection Summary						
Average Delay			2.9			
Intersection Capacity Utilization			47.1%	ICU Level of Service	A	
Analysis Period (min)			15			

HCM Unsignalized Intersection Capacity Analysis

24: Combs Flat Rd & Lynn Blvd

5/2/2013



Movement	EBL	EBR	NBL	NBT	SBT	SBR
Lane Configurations						
Volume (veh/h)	90	260	140	110	225	95
Sign Control	Stop			Free	Free	
Grade	0%			0%	0%	
Peak Hour Factor	0.85	0.85	0.85	0.85	0.85	0.85
Hourly flow rate (vph)	106	306	165	129	265	112
Pedestrians				4		
Lane Width (ft)				12.0		
Walking Speed (ft/s)				4.0		
Percent Blockage				0		
Right turn flare (veh)						
Median type				None	None	
Median storage (veh)						
Upstream signal (ft)						
pX, platoon unblocked						
vC, conflicting volume	779	325	376			
vC1, stage 1 conf vol						
vC2, stage 2 conf vol						
vCu, unblocked vol	779	325	376			
tC, single (s)	6.4	6.2	4.1			
tC, 2 stage (s)						
tF (s)	3.5	3.3	2.2			
p0 queue free %	66	57	86			
cM capacity (veh/h)	310	707	1166			
Direction, Lane #	EB 1	NB 1	SB 1			
Volume Total	412	294	376			
Volume Left	106	165	0			
Volume Right	306	0	112			
cSH	532	1166	1700			
Volume to Capacity	0.77	0.14	0.22			
Queue Length 95th (ft)	182	13	0			
Control Delay (s)	31.2	5.4	0.0			
Lane LOS	D	A				
Approach Delay (s)	31.2	5.4	0.0			
Approach LOS	D					
Intersection Summary						
Average Delay			13.3			
Intersection Capacity Utilization		67.0%		ICU Level of Service		C
Analysis Period (min)			15			

HCM Unsignalized Intersection Capacity Analysis

25: OR126 (WB) & US 26/US 26 (WB)

5/2/2013



Movement	EBT	EBR	WBL	WBT	NBL	NBR
Lane Configurations				↑	↗	
Volume (veh/h)	0	0	0	739	160	0
Sign Control	Free			Free	Stop	
Grade	0%			0%	0%	
Peak Hour Factor	0.95	0.95	0.95	0.95	0.95	0.95
Hourly flow rate (vph)	0	0	0	778	168	0
Pedestrians						
Lane Width (ft)						
Walking Speed (ft/s)						
Percent Blockage						
Right turn flare (veh)						
Median type	None		TWLTL			
Median storage (veh)	2					
Upstream signal (ft)						
pX, platoon unblocked						
vC, conflicting volume			0		778	0
vC1, stage 1 conf vol	0					
vC2, stage 2 conf vol	778					
vCu, unblocked vol			0		778	0
tC, single (s)			4.1		6.5	6.2
tC, 2 stage (s)	5.5					
tF (s)			2.2		3.6	3.3
p0 queue free %			100		60	100
cM capacity (veh/h)			1604		419	1091
Direction, Lane #						
	WB 1	NB 1				
Volume Total	778	168				
Volume Left	0	168				
Volume Right	0	0				
cSH	1700	419				
Volume to Capacity	0.46	0.40				
Queue Length 95th (ft)	0	49				
Control Delay (s)	0.0	19.2				
Lane LOS			C			
Approach Delay (s)	0.0	19.2				
Approach LOS			C			
Intersection Summary						
Average Delay			3.4			
Intersection Capacity Utilization			97.5%	ICU Level of Service		F
Analysis Period (min)	15					

HCM Unsignalized Intersection Capacity Analysis

26: OR 26 & OR 126

5/2/2013

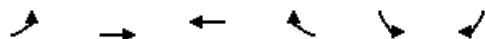

Movement	EBL	EBT	WBT	WBR	SBL	SBR
Lane Configurations		↑			↓	
Volume (veh/h)	0	760	0	0	73	0
Sign Control		Free	Free		Yield	
Grade		0%	0%		0%	
Peak Hour Factor	0.94	0.94	0.94	0.94	0.94	0.94
Hourly flow rate (vph)	0	809	0	0	78	0
Pedestrians						
Lane Width (ft)						
Walking Speed (ft/s)						
Percent Blockage						
Right turn flare (veh)						
Median type		TWLTL	None			
Median storage (veh)		2				
Upstream signal (ft)						
pX, platoon unblocked						
vC, conflicting volume	0				809	0
vC1, stage 1 conf vol					0	
vC2, stage 2 conf vol					809	
vCu, unblocked vol	0				809	0
tC, single (s)	4.1				6.4	6.2
tC, 2 stage (s)					5.4	
tF (s)	2.2				3.5	3.3
p0 queue free %	100				82	100
cM capacity (veh/h)	1636				430	1091















Direction, Lane #	EB 1	SB 1
Volume Total	809	78
Volume Left	0	78
Volume Right	0	0
cSH	1700	430
Volume to Capacity	0.48	0.18
Queue Length 95th (ft)	0	17
Control Delay (s)	0.0	15.2
Lane LOS		C
Approach Delay (s)	0.0	15.2
Approach LOS		C

Intersection Summary			
Average Delay		1.3	
Intersection Capacity Utilization	50.7%	ICU Level of Service	A
Analysis Period (min)	15		

HCM Unsignalized Intersection Capacity Analysis

27: US 26 (EB) & OR 126/OR 126 (WB)

5/2/2013

												
Movement	EBL	EBT	EBR	WBL	WBT	WBR	NBL	NBT	NBR	SBL	SBT	SBR
Lane Configurations												
Volume (veh/h)	0	0	0	0	675	0	0	0	0	0	73	0
Sign Control	Free			Free			Stop			Stop		
Grade	0%			0%			0%			0%		
Peak Hour Factor	0.95	0.95	0.95	0.95	0.95	0.95	0.95	0.95	0.95	0.95	0.95	0.95
Hourly flow rate (vph)	0	0	0	0	711	0	0	0	0	0	77	0
Pedestrians												
Lane Width (ft)												
Walking Speed (ft/s)												
Percent Blockage												
Right turn flare (veh)												
Median type	None			None								
Median storage (veh)												
Upstream signal (ft)												
pX, platoon unblocked												
vC, conflicting volume	711	0			749			711	0	711	711	711
vC1, stage 1 conf vol												
vC2, stage 2 conf vol												
vCu, unblocked vol	711	0			749			711	0	711	711	711
tC, single (s)	4.1	4.1			7.1			6.5	6.2	7.1	6.5	6.2
tC, 2 stage (s)												
tF (s)	2.2	2.2			3.5			4.0	3.3	3.5	4.0	3.3
p0 queue free %	100	100			100			100	100	100	78	100
cM capacity (veh/h)	898	1636			276			361	1091	351	356	437
Direction, Lane #	WB 1	SB 1										
Volume Total	711	77										
Volume Left	0	0										
Volume Right	0	0										
cSH	1700	356										
Volume to Capacity	0.42	0.22										
Queue Length 95th (ft)	0	21										
Control Delay (s)	0.0	17.9										
Lane LOS		C										
Approach Delay (s)	0.0	17.9										
Approach LOS		C										
Intersection Summary												
Average Delay				1.7								
Intersection Capacity Utilization	46.0%			ICU Level of Service			A					
Analysis Period (min)	15											

HCM Unsignalized Intersection Capacity Analysis

28: NW Oneil Hwy & Ochoco Hwy

5/2/2013

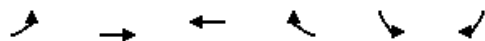

Movement	EBL	EBT	WBT	WBR	SBL	SBR
Lane Configurations	↶	↷	↷↶		↶	↷
Volume (veh/h)	20	895	645	140	90	10
Sign Control		Free	Free		Stop	
Grade		0%	0%		0%	
Peak Hour Factor	0.91	0.91	0.91	0.91	0.91	0.91
Hourly flow rate (vph)	22	984	709	154	99	11
Pedestrians						
Lane Width (ft)						
Walking Speed (ft/s)						
Percent Blockage						
Right turn flare (veh)						
Median type		TWLTL	None			
Median storage (veh)		2				
Upstream signal (ft)						
pX, platoon unblocked						
vC, conflicting volume	863				1813	431
vC1, stage 1 conf vol					786	
vC2, stage 2 conf vol					1027	
vCu, unblocked vol	863				1813	431
tC, single (s)	4.2				6.8	7.0
tC, 2 stage (s)					5.8	
tF (s)	2.2				3.5	3.3
p0 queue free %	97				60	98
cM capacity (veh/h)	757				246	567
Direction, Lane #	EB 1	EB 2	WB 1	WB 2	SB 1	
Volume Total	22	984	473	390	110	
Volume Left	22	0	0	0	99	
Volume Right	0	0	0	154	11	
cSH	757	1700	1700	1700	261	
Volume to Capacity	0.03	0.58	0.28	0.23	0.42	
Queue Length 95th (ft)	2	0	0	0	51	
Control Delay (s)	9.9	0.0	0.0	0.0	28.5	
Lane LOS	A				D	
Approach Delay (s)	0.2		0.0		28.5	
Approach LOS					D	
Intersection Summary						
Average Delay			1.7			
Intersection Capacity Utilization			59.4%		ICU Level of Service	B
Analysis Period (min)			15			

HCM Unsignalized Intersection Capacity Analysis
 29: OR 126 & S Rimrock Rd



















5/2/2013

	↙	↖	↑	↗	↘	↓
Movement	WBL	WBR	NBT	NBR	SBL	SBT
Lane Configurations	↙		↑	↗	↘	↘↘
Volume (veh/h)	5	35	880	10	50	605
Sign Control	Stop		Free			Free
Grade	0%		0%			0%
Peak Hour Factor	0.93	0.93	0.93	0.93	0.93	0.93
Hourly flow rate (vph)	5	38	946	11	54	651
Pedestrians						
Lane Width (ft)						
Walking Speed (ft/s)						
Percent Blockage						
Right turn flare (veh)						
Median type			None		TWLTL	
Median storage (veh)					2	
Upstream signal (ft)						
pX, platoon unblocked						
vC, conflicting volume	1379	946			957	
vC1, stage 1 conf vol	946					
vC2, stage 2 conf vol	433					
vCu, unblocked vol	1379	946			957	
tC, single (s)	6.8	7.1			4.3	
tC, 2 stage (s)	5.8					
tF (s)	3.5	3.4			2.3	
p0 queue free %	98	85			92	
cM capacity (veh/h)	306	250			678	
Direction, Lane #	WB 1	NB 1	NB 2	SB 1	SB 2	SB 3
Volume Total	43	946	11	54	325	325
Volume Left	5	0	0	54	0	0
Volume Right	38	0	11	0	0	0
cSH	255	1700	1700	678	1700	1700
Volume to Capacity	0.17	0.56	0.01	0.08	0.19	0.19
Queue Length 95th (ft)	15	0	0	7	0	0
Control Delay (s)	21.9	0.0	0.0	10.8	0.0	0.0
Lane LOS	C			B		
Approach Delay (s)	21.9	0.0		0.8		
Approach LOS	C					
Intersection Summary						
Average Delay			0.9			
Intersection Capacity Utilization			60.3%		ICU Level of Service	B
Analysis Period (min)			15			

HCM Unsignalized Intersection Capacity Analysis

30: Tom McCall Rd & OR 126





















5/2/2013

												
Movement	EBL	EBT	EBR	WBL	WBT	WBR	NBL	NBT	NBR	SBL	SBT	SBR
Lane Configurations												
Volume (veh/h)	30	705	10	30	510	70	25	5	60	125	10	75
Sign Control		Free			Free			Stop			Stop	
Grade		0%			0%			0%			0%	
Peak Hour Factor	0.80	0.80	0.80	0.80	0.80	0.80	0.80	0.80	0.80	0.80	0.80	0.80
Hourly flow rate (vph)	38	881	12	38	638	88	31	6	75	156	12	94
Pedestrians												
Lane Width (ft)												
Walking Speed (ft/s)												
Percent Blockage												
Right turn flare (veh)												
Median type		None			None							
Median storage (veh)												
Upstream signal (ft)												
pX, platoon unblocked												
vC, conflicting volume	725			894			1769	1756	881	1747	1681	638
vC1, stage 1 conf vol												
vC2, stage 2 conf vol												
vCu, unblocked vol	725			894			1769	1756	881	1747	1681	638
tC, single (s)	4.4			4.1			7.2	6.5	6.3	7.1	6.5	6.3
tC, 2 stage (s)												
tF (s)	2.5			2.2			3.6	4.0	3.4	3.5	4.0	3.4
p0 queue free %	95			95			24	92	78	0	86	80
cM capacity (veh/h)	752			759			41	78	334	45	86	468
Direction, Lane #	EB 1	EB 2	WB 1	WB 2	NB 1	SB 1						
Volume Total	919	12	675	88	112	262						
Volume Left	38	0	38	0	31	156						
Volume Right	0	12	0	88	75	94						
cSH	752	1700	759	1700	106	69						
Volume to Capacity	0.05	0.01	0.05	0.05	1.06	3.78						
Queue Length 95th (ft)	4	0	4	0	180	Err						
Control Delay (s)	1.4	0.0	1.3	0.0	181.8	Err						
Lane LOS	A		A		F	F						
Approach Delay (s)	1.4		1.2		181.8	Err						
Approach LOS					F	F						
Intersection Summary												
Average Delay			1279.7									
Intersection Capacity Utilization			93.1%		ICU Level of Service				F			
Analysis Period (min)			15									

HCM Unsignalized Intersection Capacity Analysis

31: SW Airport Rd & Ochoco Hwy



















5/2/2013

												
Movement	EBL	EBT	EBR	WBL	WBT	WBR	NBL	NBT	NBR	SBL	SBT	SBR
Lane Configurations												
Volume (veh/h)	5	660	15	40	565	5	20	10	75	10	5	10
Sign Control		Free			Free			Stop			Stop	
Grade		0%			0%			0%			0%	
Peak Hour Factor	0.83	0.83	0.83	0.83	0.83	0.83	0.83	0.83	0.83	0.83	0.83	0.83
Hourly flow rate (vph)	6	795	18	48	681	6	24	12	90	12	6	12
Pedestrians												
Lane Width (ft)												
Walking Speed (ft/s)												
Percent Blockage												
Right turn flare (veh)												
Median type		None			None							
Median storage (veh)												
Upstream signal (ft)												
pX, platoon unblocked												
vC, conflicting volume	687			813			1599	1590	795	1681	1602	681
vC1, stage 1 conf vol												
vC2, stage 2 conf vol												
vCu, unblocked vol	687			813			1599	1590	795	1681	1602	681
tC, single (s)	4.4			4.4			7.3	6.5	6.4	7.4	7.0	6.4
tC, 2 stage (s)												
tF (s)	2.5			2.4			3.7	4.0	3.4	3.8	4.5	3.5
p0 queue free %	99			93			65	88	75	70	92	97
cM capacity (veh/h)	778			714			68	100	366	41	76	421
Direction, Lane #	EB 1	EB 2	EB 3	WB 1	WB 2	WB 3	NB 1	SB 1				
Volume Total	6	795	18	48	681	6	127	30				
Volume Left	6	0	0	48	0	0	24	12				
Volume Right	0	0	18	0	0	6	90	12				
cSH	778	1700	1700	714	1700	1700	175	75				
Volume to Capacity	0.01	0.47	0.01	0.07	0.40	0.00	0.72	0.40				
Queue Length 95th (ft)	1	0	0	6	0	0	117	41				
Control Delay (s)	9.7	0.0	0.0	10.4	0.0	0.0	65.8	82.6				
Lane LOS	A			B			F	F				
Approach Delay (s)	0.1			0.7			65.8	82.6				
Approach LOS							F	F				
Intersection Summary												
Average Delay			6.6									
Intersection Capacity Utilization			51.8%		ICU Level of Service			A				
Analysis Period (min)			15									

HCM Unsignalized Intersection Capacity Analysis

40: Main St & Peters Rd

5/2/2013

												
Movement	EBL	EBT	EBR	WBL	WBT	WBR	NBL	NBT	NBR	SBL	SBT	SBR
Lane Configurations												
Sign Control		Stop			Stop			Stop			Stop	
Volume (vph)	75	35	20	90	50	15	20	200	200	65	75	70
Peak Hour Factor	0.81	0.81	0.81	0.81	0.81	0.81	0.81	0.81	0.81	0.81	0.81	0.81
Hourly flow rate (vph)	93	43	25	111	62	19	25	247	247	80	93	86
Direction, Lane #	EB 1	WB 1	NB 1	NB 2	SB 1	SB 2						
Volume Total (vph)	160	191	272	247	80	179						
Volume Left (vph)	93	111	25	0	80	0						
Volume Right (vph)	25	19	0	247	0	86						
Hadj (s)	0.02	0.06	0.03	-0.60	0.50	-0.33						
Departure Headway (s)	5.7	5.7	5.5	3.2	6.4	5.6						
Degree Utilization, x	0.26	0.30	0.41	0.22	0.14	0.28						
Capacity (veh/h)	568	577	609	1122	525	601						
Control Delay (s)	10.7	11.1	12.3	7.1	9.3	9.5						
Approach Delay (s)	10.7	11.1	9.8		9.5							
Approach LOS	B	B	A		A							
Intersection Summary												
Delay			10.1									
Level of Service			B									
Intersection Capacity Utilization			42.8%	ICU Level of Service	A							
Analysis Period (min)			15									

Appendix F Concept of
Channelization for
O'Neil Highway/OR
126

H:\proj\file\11168 - OR 126 Powell Butte Corridor Evaluation\divgs\Final\Concepts\Civil\037213-TRANS-Oneill-TR00-INT.dwg Sep 07, 2011 - 2:11pm - cbergh Layout Tab: 03 ONEILL HWY (OR 370)



SHORT-TERM INTERSECTION IMPLEMENTATION PROJECT
OR 126/O'NEIL HIGHWAY
CROOK COUNTY, OREGON

FIGURE
O1a

R:\bnd\111168 - OR 126 Powell Bltte Corridor Evaluation\dwgs\FinalConcepts\Civil\037213-TRANS-0neill-TR00-INT.dwg Aug 28, 2013 - 2:53pm - openbnd Layout Tab - 04 O'NEILL HWY (OR 370)



LONG-TERM INTERSECTION IMPLEMENTATION PROJECT
OR 126/O'NEIL HIGHWAY
CROOK COUNTY, OREGON

Section 7
Technical Memorandum 7: Preferred Alternative





CITY OF PRINEVILLE TRANSPORTATION SYSTEM PLAN



TECHNICAL MEMORANDUM #7: PREFERRED ALTERNATIVE

This memorandum presents the preferred transportation system alternative for addressing the multimodal transportation needs that were identified through analysis of existing and future (2035) traffic conditions in Prineville. This memorandum identifies the projects, costs, priorities, and potential funding partnerships between the City, County, and ODOT.

TRANSPORTATION NEEDS

The existing conditions and no-build memoranda document the multimodal transportation system needs related to safety, operations, and connectivity necessary to support population and job growth through the year 2035. These needs were used to develop various alternatives, which were vetted by the project advisory committees. This preferred alternative summarizes the roadway improvement projects throughout the City.

ROADWAY FUNCTIONAL CLASSIFICATION

The City's Roadway Functional Classification system identifies where collector and arterial roadways will be located and how they will be connected to serve growth within the Prineville urban growth boundary. The recommended roadway functional classification has been revised based on the selection of a Preferred Alternative as further addressed within this memorandum.

The purpose of this classification system is as follows:

- Identify City connectivity and general alignment needs to serve urban development.
- Inform right-of-way preservation and roadway construction needs as part of property development or redevelopment.
- Provide guidance on priorities.
- Identify a process for exceptions or deviations from the standards based on area-specific context or other considerations.

Figure 7-1 illustrates the recommended roadway functional classification system within Prineville. This recommended functional classification system categorizes the City's primary roadways as *Major* and *Minor Arterials* and *Major* and *Minor Collectors*. All other roadways are classified as *Local Streets*. This classification map also includes *Vision Elements*; these roadways are located within the UGB but are not needed to serve the anticipated 20-year growth. The location and alignment shown is intended to preserve right-of-way for future connections.

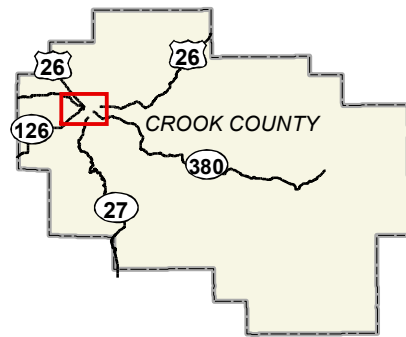

Functional Roadway Classifications

Major Arterial

Minor Arterial

Existing

Future

Major Collector

Existing

Future

Vision

Minor Collector

Existing

Future

Vision

City Boundary

Study Area/Urban Growth Boundary (UGB)

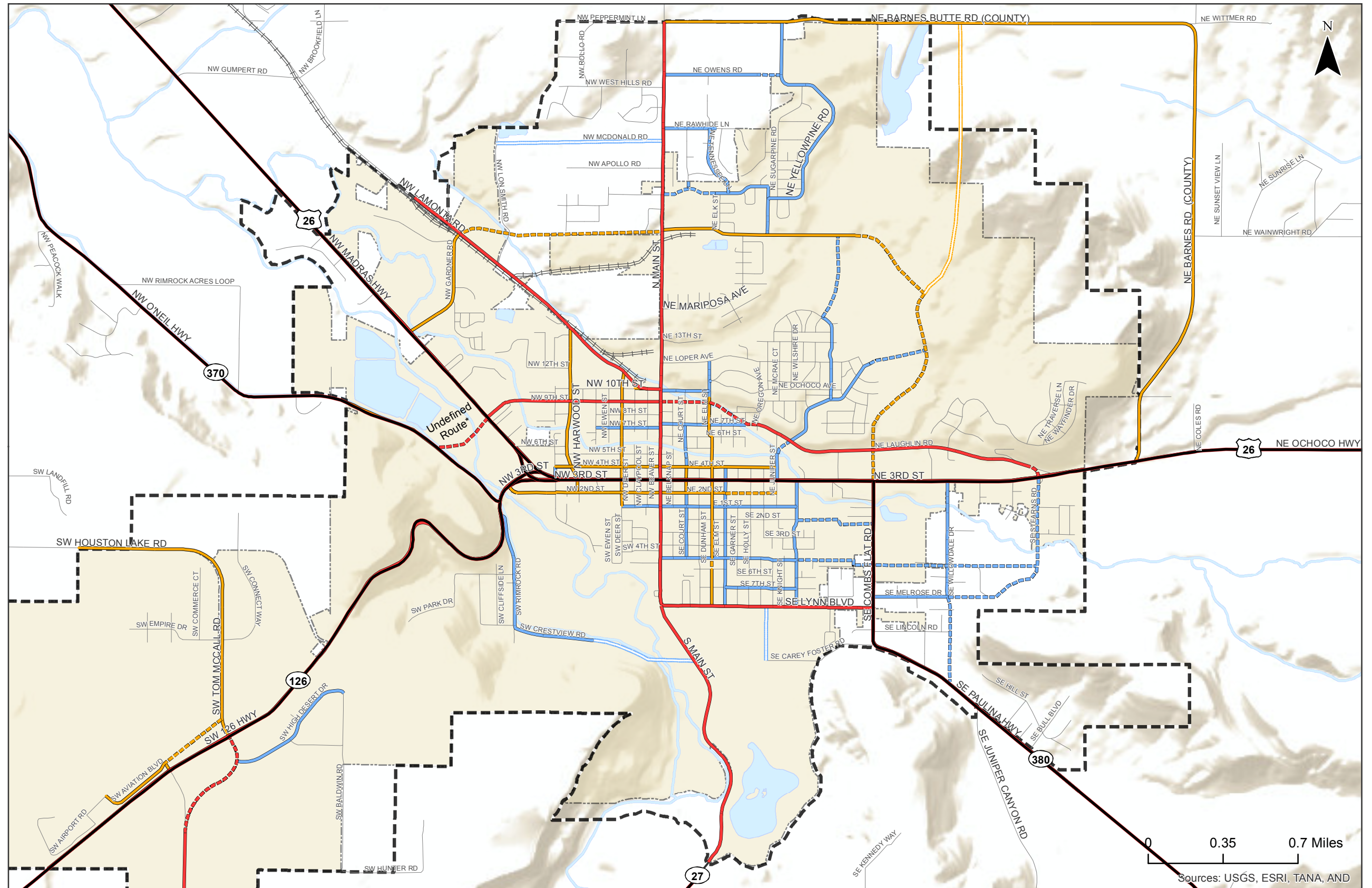

* OR 370 should be rerouted to connect with US 26, but is not needed within the 20-year planning horizon. Route is yet to be determined.

Proposed Functional Classification
City of Prineville, Oregon

Figure
7-1

K:\H_Perland\proj\12221 - Prineville TSP\GIS\Memo 717-1 Proposed Functional Classification.mxd - cbragh - 9:41 AM 6/12/2013

Generally, priority issues this classification scheme addresses are:

- Continued identification of a northern extension of Combs Flat Road to connect through the Iron Horse property to Peters Road. This connection forms a parallel route to Main Street for east Prineville, and connects north Prineville with shopping, school, commute, and recreation routes.
- Relocation of the O'Neil Highway connection to OR 126. A specific location for the highway is not identified, and would need to be further reviewed in the land use and infrastructure context at the time a relocation was considered.
- An extension of Peters Road from its intersection with Main Street west to Lamonta Road, connecting with Gardner Road, and ultimately to US 26. This roadway would serve adjacent industrial lands and provide a collector roadway function to reduce traffic on Main Street and 3rd Street.
- Alignment of Tom McCall and Millican Road within the City's industrial lands. The consolidation of these intersections would allow intersection improvements at OR 126 to benefit connectivity to the north and south sides of the highway.
- Extension of S 2nd Street east to connect to Combs Flat Road. This connection will provide a parallel route to Lynn Boulevard and 3rd Street, improving the grid network in the southern portion of the City.
- Extension of S 5th Street east to connect to SE Willowdale Drive/Ochoco Logging Road. This connection will provide a parallel route to Lynn Boulevard and 3rd Street, improving the grid network in the southern portion of the City.
- Connect the missing segment of Elm Street between S 5th Street and S 6th Street. This will improve north-south connectivity between downtown Prineville and the schools.
- Classifications were modified to follow standard naming conventions. These naming conventions clarify the distinction between local streets and higher-order roadways.

The need to construct, extend, or improve specific corridors may only occur with development, or could be provided as land sales occur to minimize impact to existing owners. The overall functional classification system is intended to serve as a blueprint that provides an orderly plan for growth, so that with development of the UGB right-of-way and connectivity will be preserved, regardless of where that development occurs.

PREFERRED ROADWAY ALTERNATIVE

This section identifies the key infrastructure needs throughout the City of Prineville based on the alternatives that were presented in Technical Memorandum #6 and discussed with the advisory committee on May 7, 2013. At this meeting, the advisory committee unanimously agreed that to address the primary congestion along Main Street and 3rd Street, development of the parallel routes alternative was preferred. This alternative to support City growth through 2035 was selected for the following reasons:

- The improvements to the City roadway network would be required under any scenario as they serve developable lands, provide travel options, reduce highway reliance, shorten trip lengths, and improve multimodal connectivity and overall accessibility.

- The parallel roadways meet the 20-year needs for the lowest overall cost of the alternatives reviewed, and will be the most likely alternative to be achieved given the current City and State funding.
- These improvements can be phased over the next 20-years as they are comprised of several stand-alone projects.
- This alternative does not preclude development of other alternatives that may be needed to serve growth beyond the 20-year horizon; these other options will remain viable if growth outpaces the 20-year projections.

The parallel routes alternative includes construction of the NE 9th Street extension, the Combs Flat Road northern extension and connection with Peters Road, the Peters Road extension to Lamonta Street at its intersection with Gardner (ultimately connecting to US 26), and includes the longer-term vision plan connection of Crestview Road to Main Street. Figure 7-2 shows the approximate locations of these parallel routes. In addition to these routes that generally serve the northern portion of Prineville, further improvements are also recommended along 2nd Street and immediately south of the downtown to complete the missing roadway segments along 2nd Street, Elm Street, and 5th Street.

Individual connections within this alternative are further described below. Major supporting roadway connections are illustrated in Figure 7-2.

Peters Road Connection to Lamonta Road



The proposed Peters Road connection would link Peters Road west past Main Street to intersect with Lamonta Road at its intersection with Gardner Road, as shown in Figure 7-2. This connection would provide a direct route between US 26 and Main Street as part of a new northern arterial, with direct access to the Iron Horse lands and industrial properties. The advisory committee was favorable of this alignment as it helps to address both the Main Street and 3rd Street congestion and provides an alternate route for northern Prineville residents.

Travel demand models showed that this connection would be expected to carry about 150 trips in each direction during the weekday evening commute hour in the year 2035, alleviating some congestion throughout the City's network and improving access to industrially-zoned properties. This project was identified as it directly addresses critical City congestion needs, improves connectivity, provides redundancy to the roadway network, and enables additional economic benefits by providing access to employment lands.

Key challenges associated with this connection and potential options are described below.

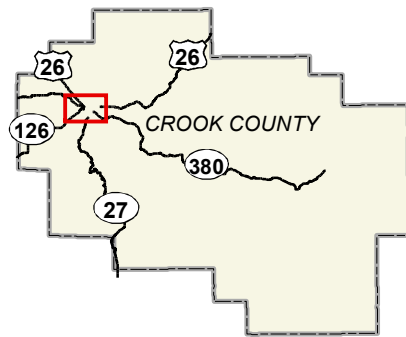
- A spur line serving the Woodgrain Millwork site crosses Main Street immediately south of its connection with Peters Road. While the at-grade crossing does not include active gates or lights and currently requires flaggers on Main Street for traffic control, future improvements at the intersection of Main Street and Peters Road should accommodate this crossing and its future potential for higher use.



-  Parallel Segments
-  City Boundary
-  Study Area/Urban Growth Boundary (UGB)

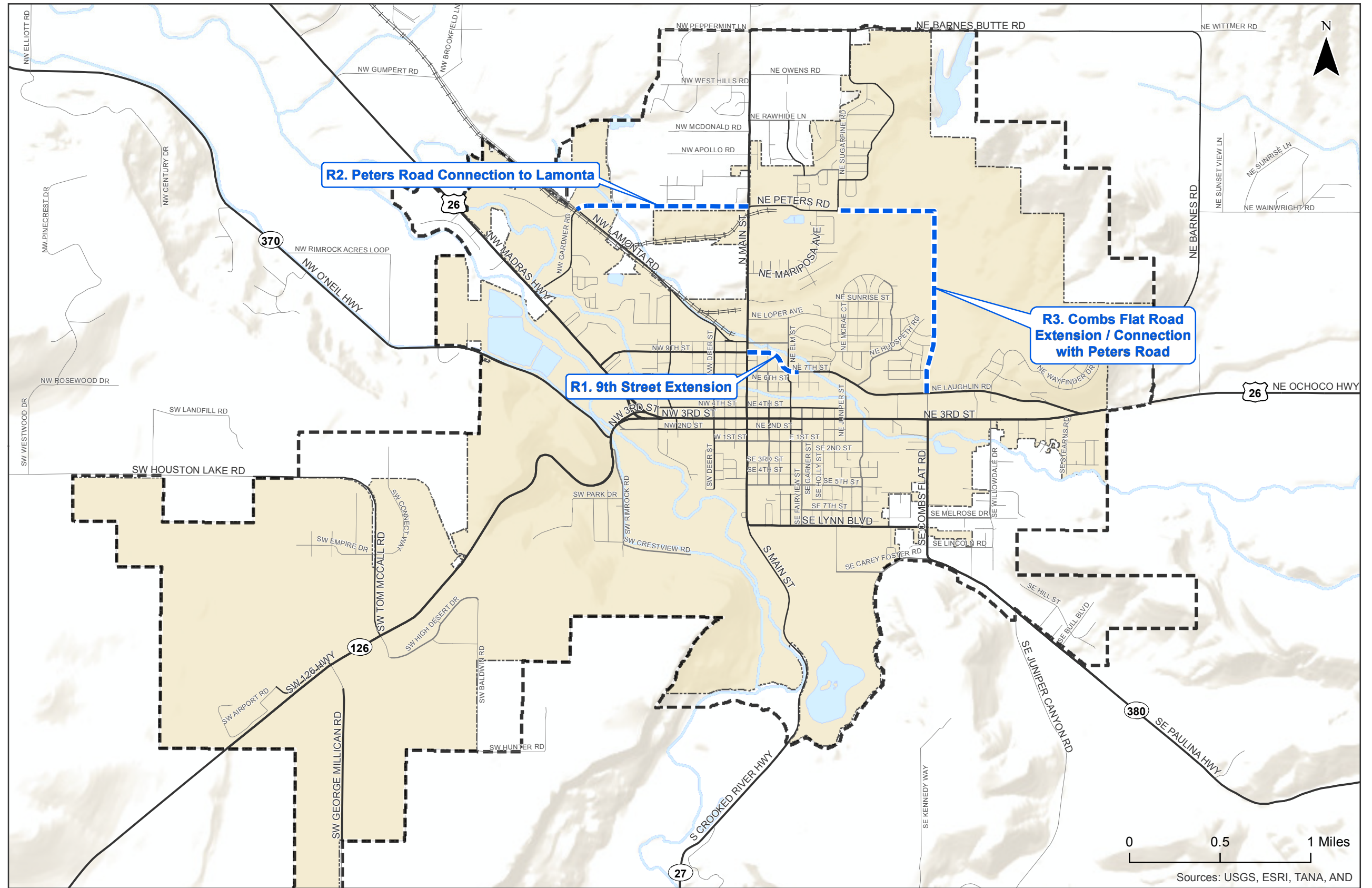

Major City of Prineville Roadway Improvements
City of Prineville, Oregon

Figure
7-2

H:\proj\12221 - Prineville TSP\GIS\Memo 716-2 Parallel Routes.mxd - 1:10 PM 6/7/2013

- The second consideration is the lack of access across this rail spur line. The line is currently used to store train cars, and any accesses across this railway should occur west of where the rail line crosses Lamonta Road to avoid additional rail crossings.
- An irrigation canal parallels Lamonta Road to the north. A new bridge or culvert would be needed to support this designated arterial connection.
- The alignment crosses multiple properties. Limited phasing could occur as part of this connection between Gardner Road and Lon Smith Road, or across private properties as development occurs. The need for both primary and secondary access to the adjacent industrial properties may limit phasing options.

9th Street Extension

The proposed 9th Street Extension, shown in Figure 7-2, completes the continuous connection along US 26 from west of the “Y” to east of Combs Flat Road. The western section of this connection has been completed to Main Street, and the offset connection to NE 7th Street and Laughlin Road currently provide the eastern connection back to US 26. Completion of a more direct 9th Street extension across Main Street would make this a more desirable route and further relieve congestion on both Main Street and 3rd Street.

While the prior Transportation System Plan identified the preferred alignment as a direct extension of 9th Street, surrounding development and other changes have occurred that may no longer provide the same preference for this alignment. The abandonment of the Prineville railway line along 10th Street provides a new right-of-way corridor north of the Price Slasher grocery store, and the increased use of Lamonta Road for freight has increased the importance of a traffic signal at the intersection of Main Street and 10th Street. Ultimately, the intent of this project is to create a continuous east-west connection with a linkage to Lamonta Road suitable for trucks.

As no funding is yet available to complete this roadway, the decision of whether to complete this connection at 9th or 10th Street should be deferred as additional land use changes are likely to occur in the interim period. Near-term projects should connect both Lamonta Road and 9th Street for freight, improve the traffic signal at 10th Street to conform to current standards, and improve the walkways along both sides of Main Street throughout the corridor.

There are several phasing options for this project, as listed below and illustrated in Exhibit 7-1:

- Improvement of Deer Street to facilitate truck traffic between Lamonta Road, 10th Street, and 9th Street. These improvements may include minor realignment, signing and striping, and corner treatments.
- Improvement of the Lamonta Road connection with 10th Street to form a perpendicular intersection with Lamonta Road as the continuous route.
- Re-alignment of 10th Street across Main Street.
- Improvements at the existing 10th Street traffic signal, to include pedestrian ramps, push buttons, and signal displays to improve accessibility.
- Restriping Main Street as a three-lane section from 9th Street to Peters Road, providing additional pavement for pedestrians and bicyclists, and better accommodating truck turns.

- Access improvements along Main Street that consolidate the vehicular, pedestrian, and bicyclist conflict points.

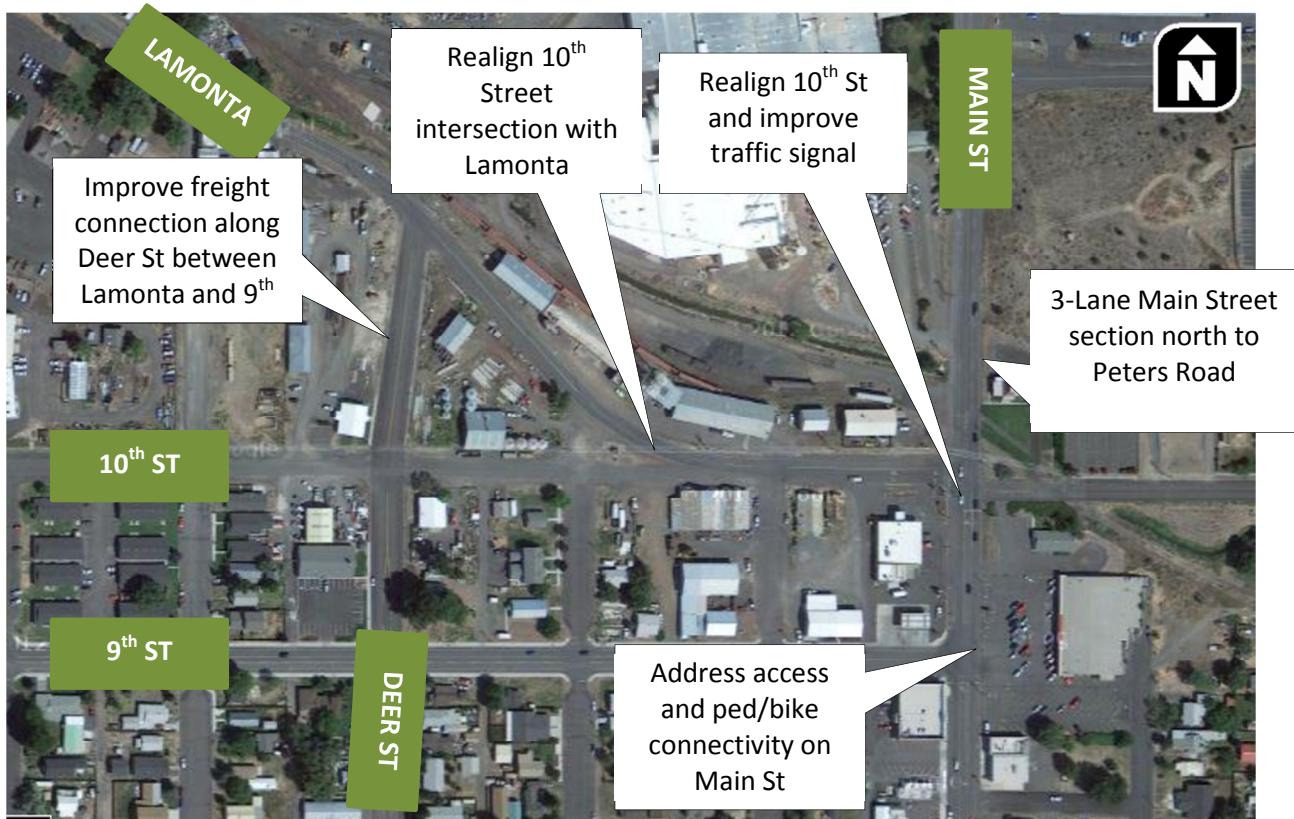

Exhibit 7-1. 9th Street extension and Main Street improvements.

Combs Flat Road

Combs Flat Road has a northern terminus at Laughlin Road, with access to the Iron Horse property currently obtained from the west through Hudspeth Road. An extension of Combs Flat Road (as a City-managed facility as opposed to a continuation of OR 380) would more directly provide access between the Iron Horse development, commercial services near 3rd Street, and recreation, and it would form an eastern route within the City parallel to Main Street. Ultimately, the arterial connection would link Combs Flat Road to Peters Road, which as previously identified, would be extended west to connect to US 26. Comments received from the advisory committee indicate that this is a high priority route given the expected development on the east side of the City, and its completion would provide a critical northern arterial route around the City to help relieve congestion on 3rd Street, shorten trips, and more directly connect travel destinations.

The Combs Flat Road corridor south of 3rd Street (OR 380) provides access to recreational and residential areas to the south. Within City limits Combs Flat Road transitions from a rural State facility into a City roadway, connecting school traffic from Lynn Boulevard to the north. The designated highway portion of this route (Combs Flat south of 3rd Street) is generally rural throughout its length, with no designated pedestrian amenities but striped bicycle lanes along the

shoulders. The corridor borders or provides access to several schools and residences, and is located adjacent to the Ochoco Lumber site that is planned for mixed-use development and is planned for the Pioneer Memorial hospital relocation. While there are specific intersection improvement needs, the general need is for Combs Flat to include turn lanes at major intersections and pedestrian and bicyclist facilities throughout its length. The desire to develop the Ochoco Lumber site as a vibrant, mixed-use area will require that the barrier effects of Combs Flat Road be reduced so that this area can be fully integrated with the downtown.

The extension of Combs Flat Road north will also require additional improvements to the built section of the facility. The two-lane section that connects through the commercial area will likely require widening to three lanes along with modal accommodations, and new turn lanes will be required at the 3rd Street/Combs Flat Road intersection and at the intersection with Laughlin Road. Depending on the growth within Iron Horse, signalization of the Laughlin Road intersection with Combs Flat may also be required.

Combs Flat Project Needs:

- Extension of Combs Flat Road north to Peters Road.
- Pedestrian and bicyclist facilities throughout the length of the corridor; completion of a mixed-use trail on one side of Combs Flat Road may be adequate with pedestrian crossings as described above.
- Enhanced pedestrian crossings, particularly at the Ochoco Creek Trail, the future 5th Street extension, and at Lynn Boulevard.
- North-south left-turn lanes at major intersections; these include Laughlin Road, 3rd Street, a future extension of 5th Street, and Lynn Boulevard.

Main Street Corridor

The Main Street corridor serves a critical north-south travel function in Prineville and has limited alternative routes today. Incidents and closures require a lengthy detour for residents along the Barnes Butte alignment. Today, the four-lane cross-section between 9th Street and Peters Road transitions to a three-lane section in the downtown area, and continues south with a three-lane section to 1st Street.

The City is currently pursuing design and construction plans that will convert the four-lane section of this road to provide a single travel lane in both directions and a continuous center left-turn lane. This narrowed three-lane section will allow for a wider shoulder area, to better accommodate pedestrian and bicyclist travel. The project is also considering potential changes to the 9th Street and 10th Street intersections with Main Street.

While these improvements help to improve multi-modal travel, the critical issue with Main Street is the reliance on this route for all north-south travel. New connections, such as a northerly extension of Combs Flat Road to Peters Road, and a western extension of Peters Road to Lamonta Road, will help reduce this reliance and lessen congestion on this route. The completion of these parallel routes, as identified in the functional classification section, are shown to adequately mitigate this overall corridor.

Main Street Project Needs:

- Consistent three-lane cross-section between 3rd Street north to Peters Road.
- Improved pedestrian and bicyclist accommodations throughout the entire corridor.
- Improved sidewalks with wider clear space and fewer conflicts in built urban areas of the corridor.

NE 2nd Street Extension

NE 2nd Street currently ends at its intersection with Fairview (at the Crooked River Elementary School), resuming east of Holly Street. The completion of this missing section would reduce reliance on NE 3rd Street for the southeastern part of the City. Completion of the connection would only occur with redevelopment of the school district property, as the roadway extension would otherwise divide the school property and conflict with the school campus layout. Exhibit 7-2 illustrates the missing section of 2nd Street.



Exhibit 7-2. 2nd Street Extension between Fairview and Holly Street.

Elm Street Extension

Elm Street serves as an important north-south connection in Prineville, extending between Loper Avenue and Lynn Boulevard with exception of the missing one block segment between 6th Street and 5th Street and an offset intersection with NE 6th Street. While classified as a local street and serving as an access for adjacent residences, this connection links the City's schools, parks, and downtown with residential areas, and contains a signalized intersection with NE 3rd Street (US 26). The completion of the missing segment could improve vehicular or multimodal north-south travel.

The parallel Fairview route is classified as a *Collector*, though this route does not provide a signal at NE 3rd Street or continue north through the Ochoco Creek park. Both roads have similar characteristics in terms of width, direct residential driveway access, and surrounding zoning/land uses. Fairview Street does provide a better connection to the school properties and the Parks and Recreation swimming pool on NE 4th Street. While it is expected to be a relatively low priority within the City to complete this extension, completion of the connection should also consider designation of this route as a *minor collector*, potentially with reduced classification of Fairview Street to a local street designation while retaining an emphasis on pedestrian and bicycle connectivity.

OR 126 (West of US 26)

The OR 126 Corridor Facility Plan identifies the need to widen OR 126 to provide a four-lane section from Tom McCall Road to the Prineville “Y” junction. East of Millican Road, the additional traffic demand from the development of the adjacent industrial lands was projected to require two travel lanes in each direction into Prineville. With the revised volume forecasts, the existing cross-section is expected to provide adequate capacity through 2035.

Therefore, previously identified widening needs are no longer required from a capacity perspective.

Highway Designations

Alternative mobility was assessed as an option within the alternatives, but was not found to be necessary with completion of the parallel routes alternative. While the Transportation System Plan assesses the 20-year planning horizon, the timing of improvements, deviations from assumed area job or housing densities, or shifting growth patterns could exceed City of Prineville or ODOT performance standards, particularly if growth occurs before the identified improvements are constructed.

The alternative mobility policies allow higher levels of congestion to delay or avoid major capital costs. Generally, State facilities that serve a regional function in addition to their local role are the facilities most likely to experience congestion. Within Prineville, US 26 (Madras-Prineville Highway and 3rd Street) and OR 126 (Ochoco Highway) carry the highest traffic volumes and experience the highest levels of congestion.

While alternative mobility is not needed in Prineville from a capacity perspective, recommendations to change the functional goals for facilities to balance local access or economic goals could be considered. Potential segment designations and their definitions from the *Oregon Highway Plan* are summarized below.

Special Transportation Area (STA)

The primary objective of managing highway facilities in an existing or future Special Transportation Area is to provide access to community activities, businesses, and residences and to accommodate pedestrian movement along and across the highway in a downtown, business district and/or community center including those in unincorporated communities as defined by OAR 660-022-0010(10). An STA is a

highway segment designation that may be applied to a highway segment when a downtown, business district, or community center straddles the state highway within an urban growth boundary or in an unincorporated community. Direct street connections and shared on-street parking are encouraged in urban areas and may be encouraged in unincorporated communities. Direct property access is limited in an STA. Local auto, pedestrian, bicycle and transit movements to the business district or community center are generally as important as the through movement of traffic. Traffic speeds are slow, generally 25 miles per hour or less.

Urban Business Area (UBA)

The Urban Business Area is a highway segment designation which may vary in size and which recognizes existing areas of commercial activity or future nodes or various types of centers of commercial activity within urban growth boundaries on District, Regional, or Statewide Highways where vehicular accessibility is important to continued economic viability. The primary objective of the state highway in an Urban Business Area (UBA) is to maintain existing speeds while balancing the access needs of abutting properties with the need to move through traffic. An UBA is a highway segment designation that may apply to an existing area of commercial activity or future center or node of commercial activity in a community located on a District, Regional, or Statewide Highway where speeds are 35 miles per hour or less. The designation of UBAs on Statewide Highways shall be limited to only those special circumstances where, from a system-wide perspective, the need for local access clearly equals or is greater than the need for mobility for an existing designation, and for a new designation the need for local access must be greater than the need for mobility. Vehicular accessibility is often as important as pedestrian, bicycle, and transit accessibility. Safe and regular street connections are encouraged. Transit turnouts, sidewalks, and bicycle lanes are accommodated.

Expressways

Expressways are complete routes or segments of existing two-lane and multi-lane highways and planned multi-lane highways that provide for safe and efficient high speed and high volume traffic movements. Their primary function is to provide for interurban travel and connections to ports and major recreation areas with minimal interruptions. A secondary function is to provide for long distance intra-urban travel in metropolitan areas. In urban areas, speeds are moderate to high. In rural areas, speeds are high. Usually there are no pedestrian facilities, and bikeways may be separated from the roadway.

Recommended strategies to better match land use and transportation needs within Prineville are as follows:

- Designation of 3rd Street (US 26) as an Urban Business Area east of Knowledge Street to Laughlin Road to support area redevelopment and revitalization, reduced highway speeds, and improved pedestrian connectivity with a lessened emphasis on throughput.
- Retention of the Special Transportation Area designation along 3rd Street between Meadow Lakes and Knowledge Street.
- Retention of the Expressway designation of OR 126 from the western UGB to its intersection with the O'Neil Highway. It was recognized that additional growth and development within the City's industrial lands may warrant review of this designation at

a future time, but the access and primary function of this corridor continue to be for mobility at this time and connectivity to the downtown area.

The designation of the eastern section of 3rd Street would help support policy and land use language being initiated by the City that are intended to reduce strip commercial and effectively extend the downtown area. Changing the designation of an ODOT facility can only be initiated through a legislative process such as a corridor plan or a transportation system plan, and would ultimately require approval through the Oregon Transportation Commission (OTC).

Vision Plan

The City's UGB provides more land than needed for a 20-year horizon. This Transportation System Plan assumes growth will occur within the City's most readily buildable lands. Over the next twenty years other areas within the City could experience growth that was not anticipated within this plan. The *Vision Plan* presents a long-range roadway framework that will allow the City to respond to changes in where, within the UGB, growth actually occurs. This Vision Plan will allow the City to consider future right-of-way needs to help provide for the orderly growth and development of the City. Vision Plan connections are illustrated in Exhibit 7-1.

INTERSECTION IMPROVEMENTS

This section describes the intersection improvements needed to mitigate the "point" congestion issues within Prineville.

Intersection Improvements

This section summarizes specific "point" improvements at intersections and junctions throughout the City, based on operational, safety, or geometric needs.

OR 126/Tom McCall Road/Millican Road

The OR 126 Corridor Facility Plan identified the need for an interchange at the OR 126/Tom McCall Road intersection and realignment of Millican Road to connect as a new southern intersection leg in the 2035 horizon year. At-grade traffic signal or roundabout solutions were identified as "interim" treatments as they did not meet the peak hour mobility targets for the highway in 2035.

Using the revised travel demand forecasts developed through this Transportation System Plan effort, growth projections were significantly reduced relative to the forecasts used in the prior OR 126 Corridor Facility Plan. These reduced projections better reflect the current data center trends in the industrial park, reduced destination resort build-out, and current travel projections and growth forecasts for Prineville. With these reduced projections an interchange may remain a longer-term need within the Vision Plan, but an at-grade intersection can meet mobility targets through the horizon year 2035 while maintaining a smaller footprint than was previously considered.

Within the OR 126 Corridor Plan a traffic signal was recommended as the preferred alternative. This treatment was selected largely due to the phasing options it would provide in moving toward a grade-separated interchange. This design provided the phasing strategy as outlined below:

- Install left-turn lanes on OR Highway 126 at Tom McCall Road
- Extend the existing westbound right-turn lane at Tom McCall Road
- Add a southbound right-turn lane on Tom McCall Road
- Add a new traffic signal at the intersection, along with approach treatments to account for the high speeds and rural environment
- Install frontage road connections to Airport Way and Millican Road, so that this traffic could use the new signal for highway access. This would also allow closure or restrictions of the current Millican/Airport Way intersections.

A second option identified in the OR 126 Corridor Facility Plan was to realign Tom McCall Road with Millican Road and install a multi-lane roundabout. The corridor plan noted that this was a more challenging project to phase and would require much of the cost up-front. In addition, when the OR 126 Corridor Facility Plan was being developed, the roundabout conflicted with ODOT policies. The relative safety benefits of a roundabout relative to a signal warranted keeping a roundabout in the corridor plan as an alternate treatment should the funding for the roundabout become available and ODOT policy changes occur.

Since adoption of the OR 126 plan, ODOT policy was revised to allow roundabouts on state highways, with the requirement that appropriate stakeholder outreach was provided with the freight community to ensure that the roundabout sizing was adequate to accommodate the dimensional needs of trucks.

Intersection Sizing Analysis

Operational analyses were conducted using the revised volume forecasts to review the potential intersection footprint under a signalized or roundabout configuration. The volume projections used in this analysis reflect a connection between Tom McCall Road and Millican both north and south of the highway, and conservatively assume that during the peak period all drivers choose to route to the improved connection.

If a roundabout were installed it would need to follow rural design guidelines. This includes extensive treatments on the intersection approaches that correspond to the travel speeds. Typical treatments involve a series of curves that transition drivers from 55 miles per hour successively to 45 miles per hour, 35 miles per hour, and an entry speed of approximately 25 miles per hour where they could yield to conflicting vehicles. The treatment would also require illumination on the approaches and at the intersection to alert drivers to the intersection control at night, and advance signing and striping.

The roundabout analysis shows that in 2035 a single-lane roundabout operates below capacity, but begins to experience queues on the eastbound approach of 11 vehicles. A sensitivity analysis was conducted to assess the impacts an increase or decrease in traffic volumes of 25 percent

would create. At the low range a single lane roundabout would work acceptably, and at the high range a second eastbound and westbound travel lane would be required to avoid the intersection exceeding capacity. Under all scenarios, a single-lane northbound and southbound approach was found to be adequate. Accordingly, it is recommended that the future design of a roundabout at this location plan for dual eastbound and westbound through lanes on the highway.

Consistent with ODOT roundabout policy, consideration of a roundabout and the approach treatments would need to include a range of stakeholders and interests along this critical freight route, particularly for over-dimensional loads. The connection Millican Road provides to US 20 is used by over-dimensional loads to avoid the congestion and lack of a direct connection between the Bend Parkway and US 20. As discussed within the OR 126 corridor plan, consideration of a gated central “pass-through” lane and retention of the existing Millican connection could be vital in accommodating these over-dimensional users, while still maintaining the safety a roundabout provides for typical highway freight and passenger vehicle users.

If a traffic signal were to be installed at this intersection the design would need to provide special accommodation of the rural nature of the highway and the expectancy of drivers to encounter a traffic signal. Similar to the roundabout, the design of the traffic signal would need to include a high degree of roadside context to help inform approaching drivers of the potential need to stop, which could include dynamic feedback signs, advance warning signs, longer all-red and yellow signal clearance intervals, and changes to the physical approach geometry and aesthetics.

The footprint of a traffic signal would need to similarly include two east-west travel lanes on OR 126, dedicated left-turn lanes on all approaches, and shared through/right-turn lanes north and south, as shown in Exhibit 7-3. While this design would provide ample reserve capacity, separate or

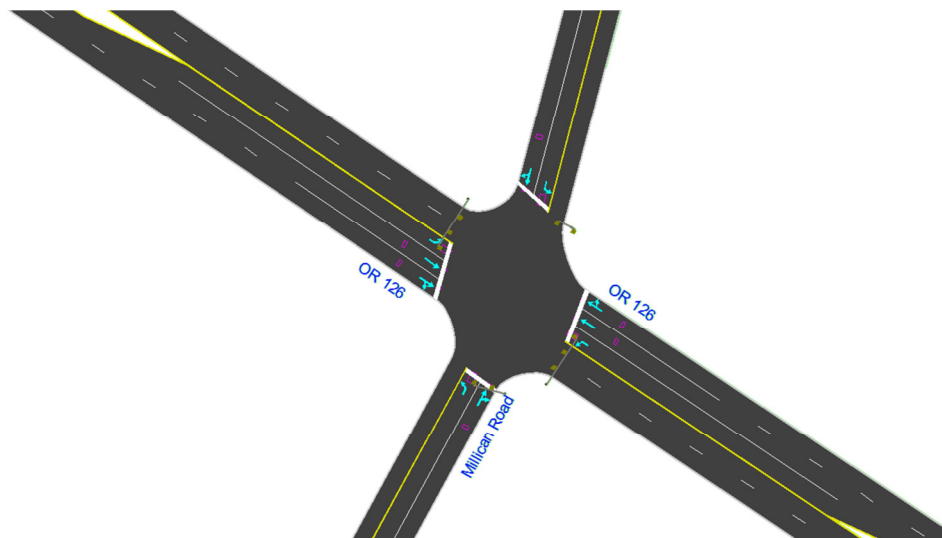

Exhibit 7-3. Signalized OR 126/Tom McCall – Millican Road footprint.

channelized right-turn lanes may also be desired to separate high speed through and turning movements and better accommodate the turning radii from the industrial lands.

The refinement of these options will be completed as part of a separate effort and amended into the City’s Transportation System Plan. The City and ODOT have been in discussions and are collaboratively developing the scope for a detailed evaluation of traffic control options at the intersection. The key goals of this process are to provide a high level of safety in this high-speed

rural area, support economic development within the City's industrial lands, and accommodate oversized freight movements within and through this area.

West "Y"

The OR 126 Corridor Facility Plan identified the need to extend queue storage on the stop-controlled approach for eastbound OR Highway 126 to westbound US 26 traffic. The plan also included long-term identification of either a traffic signal or multilane roundabout; either could provide acceptable operations.

With the revised growth forecasts for OR 126 the existing traffic control will be adequate to accommodate the 20-year growth projections. Some improvements may continue to be required to extend the available vehicular storage bays, manage and define access, and improve sight distance.

O'Neil Hwy (OR 370)/OR 126

The OR 126 Corridor Facility Plan identified an interim option that would allow left-turns from the O'Neil Highway to cross a single lane of traffic on OR 126 before merging into eastbound traffic. A concept of the channelization was prepared for the Corridor Plan project, and is shown in Exhibit 7-4.

Without any improvements, by 2035 forecast traffic volumes are expected to exceed the intersection capacity. However, public comments also indicate a desire for improved connections to the pedestrian trail system that connects with the Ochoco Viewpoint, and implementation of this interim treatment would make those pedestrian crossings more difficult to accommodate. Exhibit 7-5 illustrates the existing intersection configuration and highlights the raised medians.

The long-range recommendation for the O'Neil Highway connection is to continue to consider alternate connections to US 26. The current location of the intersection of these two highways along the grade provides high-speed conflicts on an inclined pavement section, and highway curvature limits the ability for motorists to adequately judge the speed and presence of oncoming vehicles. A specific location for this connection was not identified at this time; the future siting will need to consider environmental and land use implications of an alternate alignment along this constrained area.



Exhibit 7-4. OR 126 Corridor Plan interim improvement concept.

Project Needs:

- Consider an alternative alignment of the O'Neil Highway to US 26.
- Consider near-term improvements that accommodate pedestrian crossings from the Crooked River Bridge across the O'Neil Highway to connect to the Ochoco Viewpoint trail systems.
- Consider OR 126 crossings to the east where speeds are lower and the roadway section is narrowed.

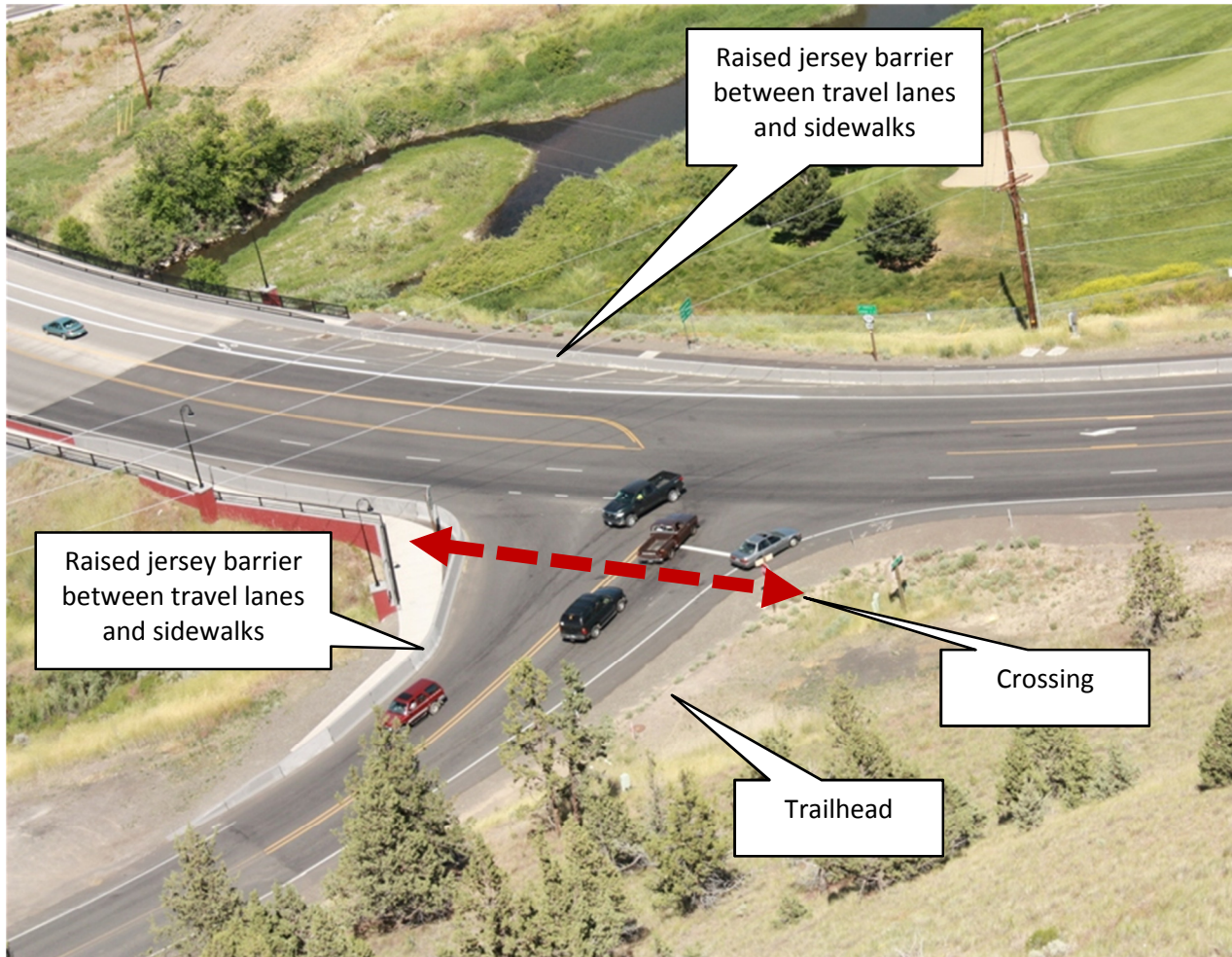

Exhibit 7-5. Existing OR 126/O'Neil Highway Intersection configuration.

Combs Flat Road/Lynn Boulevard

A significant amount of growth is projected to occur outside of the City, and with the completion of the 2nd Street extension a higher volume of traffic is utilizing Main Street and Lynn Boulevard to provide this connection. Growth along Combs Flat Road is also influenced by the nearby schools, and experiences high peaking characteristics.

It is recommended that this intersection be signalized when warranted. The need and timing of this improvement will be driven by growth, and should be monitored as part of development

applications that would create an impact. Near-term, a crosswalk should be installed to allow pedestrians to cross the highway. The high speeds along this section of Combs Flat Road will likely require advance warnings to motorists. Ultimately, this crosswalk should connect to the shared-use path recommended for the east side of Combs Flat Road that would connect north to US 26 - 3rd Street.

Main Street/Lynn Boulevard

Similar to the intersection of Combs Flat Road and Lynn Boulevard, the need to signalize the intersection of Main Street and Lynn Boulevard will be driven by growth in southern Prineville, particularly within the Anglers' Canyon development or any other development that connects to the south. This intersection should be planned for future signalization, with a traffic signal installed only when warranted.

Harwood Avenue/Lamonta Road

The intersection of Harwood and Lamonta Road provides an unconventional geometry, as shown within the inset. The intersection contains only single turn lanes, but dual receiving lanes for southbound traffic along with a very short merge area. Restriping to provide a single southbound travel lane and better delineation of the radius would address the intersection needs.

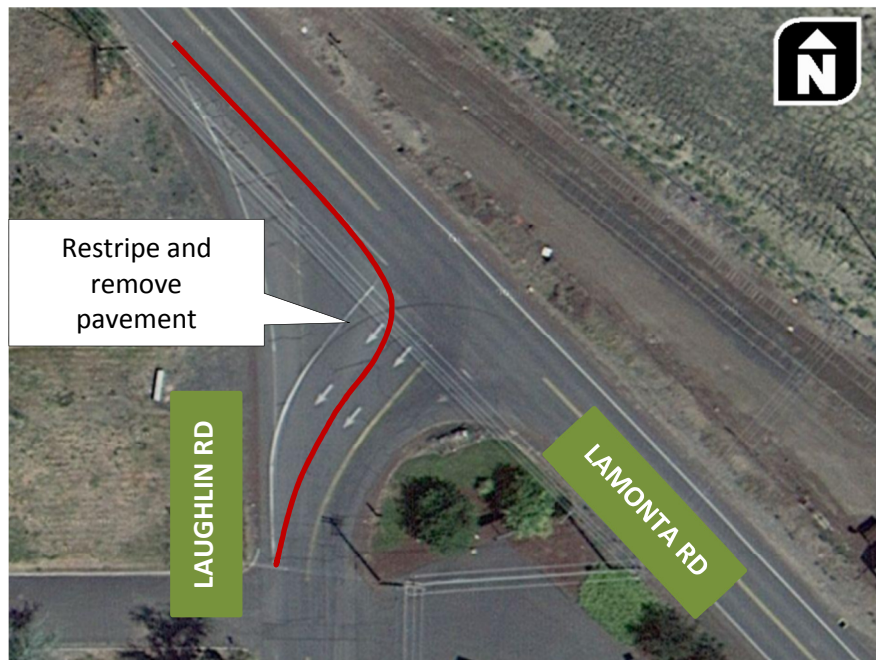

Exhibit 7-6. Harwood and Lamonta Road intersection improvements.

OR 126/US 26 - 3rd Street/Laughlin Road

The connection of Laughlin Road with US 26/OR 126 - 3rd Street forms a skewed intersection with a separate westbound "slip lane" treatment, with a private driveway access located on the slip lane adjacent to the highway. Regardless of whether the City completes the 9th Street extension, it is recommended that this intersection be reconfigured as a more conventional perpendicular "T" intersection. A more conventional channelized right-turn lane design could allow this to remain as an attractive alternate route to the highway for westbound motorists. Goals of this design would be to provide a more clearly defined connection to the highway and reduce the pedestrian and bicyclist conflict area.

Intersection Realignment

There are several locations in Prineville where roadways are poorly aligned, or segments of roadway are missing. Intersection alignment helps improve safety, simplifies driver decisions, and provides more continuous routes. A complete grid network provides travelers with options and better accommodates pedestrian and bicycle trips by making them more direct. The locations noted are as follows:

- 10th Street and Lamonta Road: These two roadways intersect at a sharp angle, making visibility more difficult. It is recommended that 10th Street be curved north near the scale to intersect with Lamonta Road at a perpendicular, stop-controlled approach. This would preserve Lamonta Road as the through route.
- The Lamonta Road/10th Street intersection with Main Street is offset by approximately 10 feet. This alignment will be addressed through the City’s current design project.

SAFETY IMPROVEMENT PLAN

A range of low-cost countermeasures were considered to address the existing crash patterns and trends observed over the study period. Detailed summaries of crash patterns and suggested countermeasures for each location are provided below.

Table 7-1 Crash Countermeasures

Location	Crash Contributing Factors	Potential Crash Countermeasures
N 3 rd Street: Maple to Claypool	Frequent driveways resulting in conflicts.	Reduce driveway density through access narrowing, closure, and/or consolidation.
N 3 rd Street/ Harwood Street	11 of 14 crashes were rear-end crashes.	Reduce congestion through development of parallel routes and conflict areas on N 3 rd Street through access narrowing, closure, and consolidation.
N 3 rd Street/ Combs Flat Road	7 of 18 crashes involved turning vehicles. 7 crashes resulted in injury.	Change left-turn signal timing from protected-permitted to protected-only on east-west approaches. This change may be unnecessary if speeds are reduced on 3 rd Street through adoption of the Urban Business Area designation.
Main Street/ N 4 th Street	9 rear-end crashes reported Congestion at the N 3 rd Street/Main Street intersection	Improve driver awareness at the N 3 rd Street/Main Street intersection through high visibility signal head treatments, and completion of parallel routes. Consider pedestrian crossing treatments such as higher-visibility crosswalks and curb bulb-outs.
N 2 nd Street/ Deer Street	4 angle crashes resulted when the driver “did not yield right-of-way” and 4 other angle crashes resulted when the driver “passed stop sign or red flasher.”	Increase sign visibility through one or more of the following: replace the stop sign with a larger size sign, install high-reflectivity tape on the sign post, or add LED lights to the sign border, improve crosswalk and stopbar striping. Alternatively, consider conversion of the intersection to all-way stop control.

N 3rd Street (US 26)

Crashes on 3rd Street accounted for 43 percent of all reported crashes within the City between January 2007 and December 2011. The majority of crashes within the 3rd Street corridor were rear-end crashes. Strategies identified to address the safety needs on 3rd Street include closure, consolidation, and narrowing of accesses. Establishing shared access easements on adjoining parcels as part of redevelopment efforts will also help to address this issue over time.

Implementation of capacity improvements (such as the development of alternative routes) will also improve safety on the highway by reducing congestion. Adoption of the Urban Business Association designation for 3rd Street east of Knowledge may also help by enabling treatments that support a lower speed travel environment.

Main Street and 9th Street Intersection

Project planning is underway to improve the Main Street intersections with 9th Street and 10th Street. The project is considering ways to improve the new 9th Street connection between US 26 and Main Street and consider how this connection can tie in with the nearby signalized connection of 10th Street – Lamonta Road. This project will be addressing the poor truck accommodations along this route, pedestrian connectivity and accessibility needs, and safety along the overall Main Street corridor between 9th Street and Peters Road.

The first phase of the project will include identification of the long-term needs and costs, with construction occurring within the second phase. It is unknown if the current funding will allow all the needed improvements to be constructed.

Main Street and 4th Street Intersection

Over the 5-year study period from 2007 through 2011, 12 crashes were reported at the Main Street and 4th Street intersection. The majority of crashes were reported as rear-end collisions (9 total). Congestion at the N 3rd Street/Main Street intersection, pedestrian activity, and on-street parking are likely contributing factors to the five reported southbound rear-end crashes that occurred on the north leg of the intersection. No geometric or traffic control changes are expected to address rear-end crashes on Main Street, but the City could consider advanced warning or indications to drivers. Implementation of improvements to signal timing and other alternatives to manage traffic on 3rd Street are expected to reduce congestion at this intersection.

Mitigation options could include the following:

- Curb bulb-outs on the corners to define the intersection, reduce speeds, delineate on-street parking areas, and increase visibility of pedestrians waiting to cross the road.
- Improve visibility of crosswalks (such as piano striping on the north-south approaches to replace the parallel lines)
- Tinted/colored crosswalks to improve intersection visibility.

N 2nd Street and Deer Street Intersection

The crash rate and percent of injury crashes at the N 2nd Street/Deer Street intersection is the highest of all study intersections reviewed. The ten reported crashes include eight angle crashes, one rear-end, and one other/unknown crash type, with one or more injuries reported in eight of the crashes.

Based on limited information provided within the crash data, four angle crashes resulted when the driver “did not yield right-of-way” and the other four angle crashes resulted when the driver “passed stop sign or red flasher.” These contributing factors suggest drivers are not stopping at the stop sign, are not yielding to major-street traffic, or cannot adequately see oncoming cars when entering the intersection. With the recent completion of the 2nd Street connection to OR 126 the east-west volume has increased along this route, and Deer Street provides one of a limited number of signalized intersections with 3rd Street.

Mitigation options include the following:

- Replacing the east-west stop signs with larger size sign.
- Installing high reflectivity tape on the sign post, or adding LED lights to the sign border to increase sign visibility.
- Providing curb bulb-outs to better highlight the intersection area and define the on-street parking areas.
- Striping higher visibility crosswalks (such as piano striping) on Deer Street and parallel bars with supplemental stop bars east-west.
- Adding “STOP” paint stenciling on the east-west approaches.
- Converting the intersection to an all-way stop.

Safety Management

In addition to the near-term safety improvements identified above, the City should continue to monitor crashes and re-assess priority improvement areas on a periodic basis. This assessment should include coordination with emergency service providers, law enforcement, and modal interests. This program can also be used to monitor the effectiveness of safety treatments implemented.

ACTIVE TRANSPORTATION ALTERNATIVES

Active transportation options, including walking and bicycling, are transportation alternatives that not only provide physical benefits to people but also reduce traffic and congestion on roadways. In order for people to choose walking and bicycling as viable modes of transportation, adequate facilities are needed to provide separation from motor vehicles and connectivity throughout the City.

Pedestrian Facilities Plan

Pedestrian facilities serve a variety of needs, including:

- Relatively short trips (generally considered to be under a mile) to major pedestrian attractors, such as schools, parks, and public facilities;
- Recreational trips (e.g., jogging or hiking) and circulation within parks;
- Access to transit (generally trips under 1/2 –mile to bus stops); and,
- Commute trips, where mixed-use development is provided and/or people have chosen to live near where they work.

Pedestrian facilities should provide continuous connections among neighborhoods, schools, employment areas, and nearby pedestrian attractors. Pedestrian facilities usually refer to sidewalks or paths, but also include pedestrian crossing treatments for high volume roadways.

Future plans for improvements to the pedestrian system are focused on strategic improvements to improve east-west and north-south connectivity throughout the City, improvements to connectivity between residential areas and schools as identified in the Safe Routes to School Action Plans for local schools, and trail improvements and connectivity identified within the Crook County Parks and Recreation District Master Plan. Multi-use trail improvements will be discussed in the multi-use trails section.







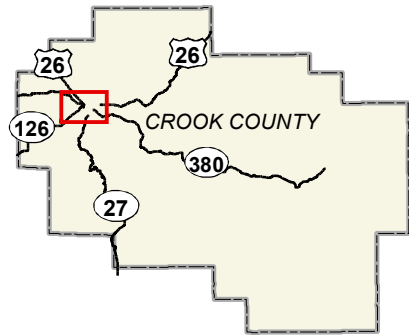

The Safe Routes to School Action Plans for Cecil Sly Elementary, Crooked River Elementary, and Crook County Middle School identified several locations needing improved pedestrian and bicycle connectivity in the southeast area of the City. Specifically, the plans called for connectivity to residential areas north of Laughlin Road by adding sidewalks along Juniper Street, Laughlin Road, Hudspeth Lane, and Oregon Street. Marked pedestrian crossings of Laughlin Road and 3rd Street are also needed to facilitate safe crossings in these locations. Additional signage and lighting should be considered to increase visibility of pedestrians to approaching drivers at crosswalks.

Figure 7-3 shows the location and extent of the planned pedestrian improvements relative to the existing pedestrian facilities within Prineville. Based on current lack of east-west and north-south connectivity as well as connections between residential areas and schools, the priority segments for pedestrian improvements include:

- Combs Flat Road: Add sidewalk on both sides of the street to provide facilities for students using Combs Flat Road to walk to school.
- Lynn Boulevard: Add sidewalk on both sides of the street.
- Juniper Street: Add sidewalk on Juniper Street between 3rd Street and E 1st Street.
- Main Street: Provide sidewalk on both sides of the street from Lynn Boulevard north to Peters Road to provide a continuous north-south connection.
- SE 5th Street: Add continuous sidewalk on both sides of the street, extending east to Ochoco Logging Road.



Destinations

-  Airport
-  Fairgrounds
-  Golf Course
-  Hospital
-  Library
-  Pool
-  School
-  Skatepark
-  Park

 Proposed Sidewalks

 Existing Sidewalks

 City Boundary

 Study Area/Urban Growth Boundary (UGB)

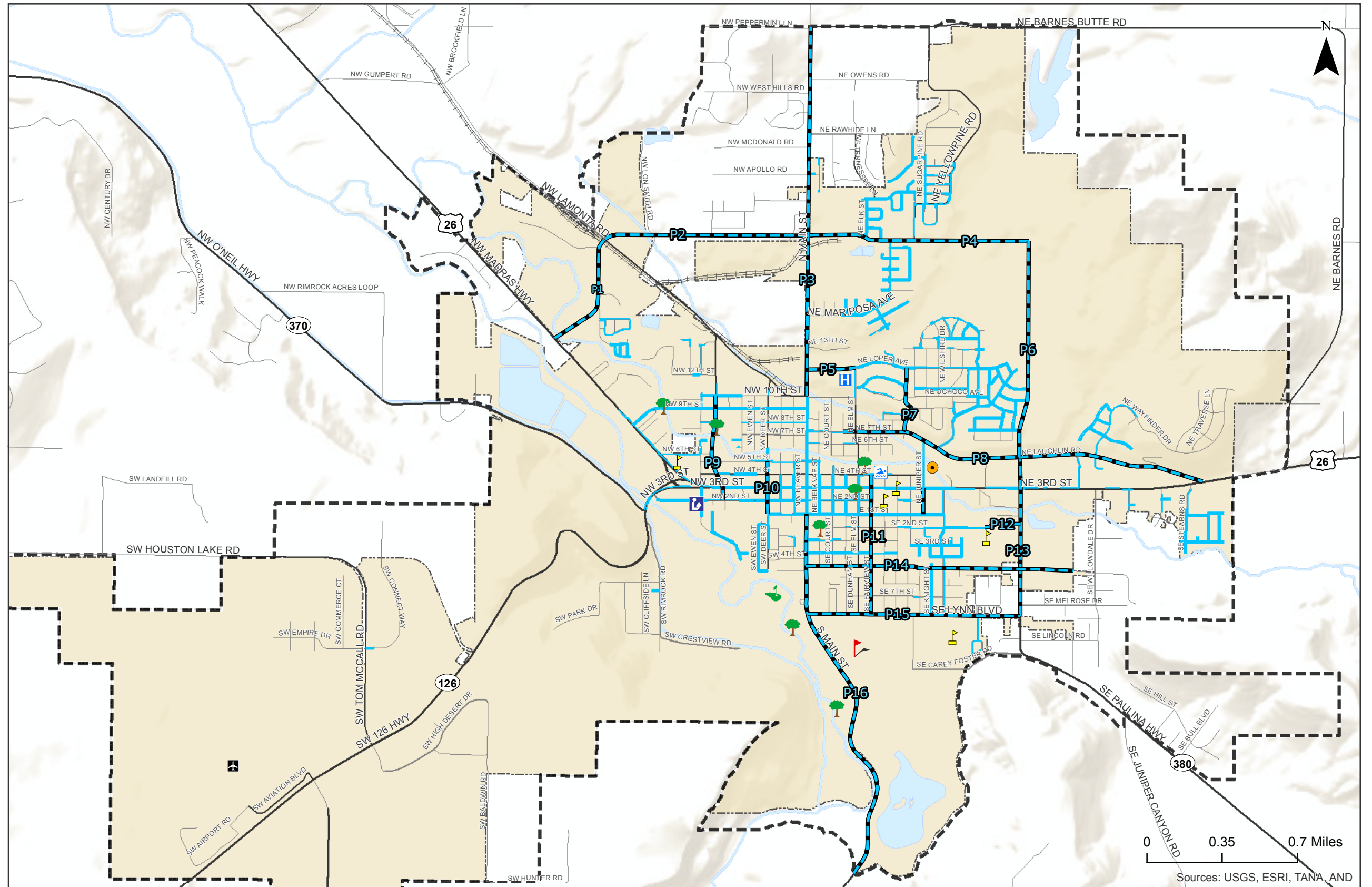

0 0.35 0.7 Miles

Sources: USGS, ESRI, TANA, AND

**Proposed Pedestrian Facilities
City of Prineville, Oregon**

**Figure
7-3**

H:\proj\12221 - Prineville TSP\GIS\Memo 717-3 Proposed Pedestrian Facilities.mxd - jsommerville - 3:45 PM 6/7/2013

- 3rd Street/Juniper Street: Add a pedestrian crossing in this area to connect residential areas from the north to the schools south of 3rd Street. Consider a high visibility crosswalk, signage, and/or pedestrian signals to raise visibility of pedestrians.
- Juniper Street/Laughlin Road: Add a pedestrian crossing to provide a safe crossing to residential neighborhoods north of Laughlin Road.
- Provide a pedestrian crossing or underpass near the intersection of O'Neil Highway and OR 126.

Bicycle

Similar to pedestrian facilities, bicycle facilities (including dedicated bicycle lanes in the paved roadway, multi-use paths shared with pedestrians, etc.) serve a variety of trips. These include:

- Trips to major attractors, such as schools, parks and open spaces, retail centers, and public facilities;
- Commute trips;
- Recreational trips; and,
- Access to transit, where bicycle storage facilities are available at the stop, or where space is available on bus-mounted bicycle racks.

Bike lanes and shared bicycle shoulders are currently provided in relatively limited areas scattered throughout the City. Existing bicycle facilities within Prineville are located on portions of 3rd Street, Main Street, Combs Flat Road, OR 126, and 9th Street. Other bicycle travel within the urban area occurs on facilities where bicycles can safely be accommodated with vehicular traffic or on existing multi-use pathways. Future plans for multi-use paths are summarized in the following section. Technical Memorandum #3 describes the existing bicycle network.







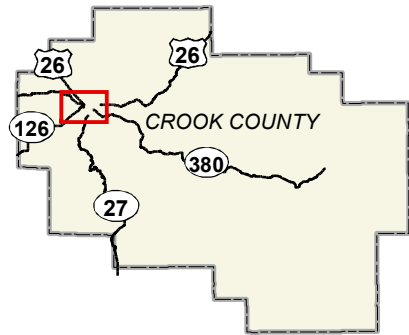







The City's map of planned bicycle projects displays future opportunities for creating a connected bicycle network. Bicycle facilities should be constructed on new collectors and arterials built within the City. In addition, bicycle facilities should be added on existing roadways when feasible to provide added connectivity throughout the City. Figure 7-4 shows existing and planned bicycle facilities to illustrate how these routes will create an interconnected network.

Several projects were identified as high priority projects based on their ability to provide increased connectivity within the City and between residential areas and schools. These routes include many of the future connections shown on the east side of the urban area. The priority routes for constructing bike lanes include:

- Knowledge Street: Add a bicycle lane to provide connectivity with local schools.
- Juniper Street: Add a bicycle lane to provide connectivity between residential neighborhoods and schools.
- Laughlin Road: Add a bicycle lane to provide alternative east-west connectivity and connectivity to residential areas of the City.
- Main Street: Construct continuous bicycle lanes within the UGB to provide a north-south route for bicyclists.
- 2nd Street or 4th Street: Provide continuous bicycle lanes to provide an east-west route parallel to 3rd Street.



Destinations

-  Airport
-  Fairgrounds
-  Golf Course
-  Hospital
-  Library
-  Pool
-  School
-  Skatepark
-  Park
-  Proposed Bike Lanes
-  Existing Bike Lane
-  Existing Bike Route
-  City Boundary
-  Study Area/Urban Growth Boundary (UGB)

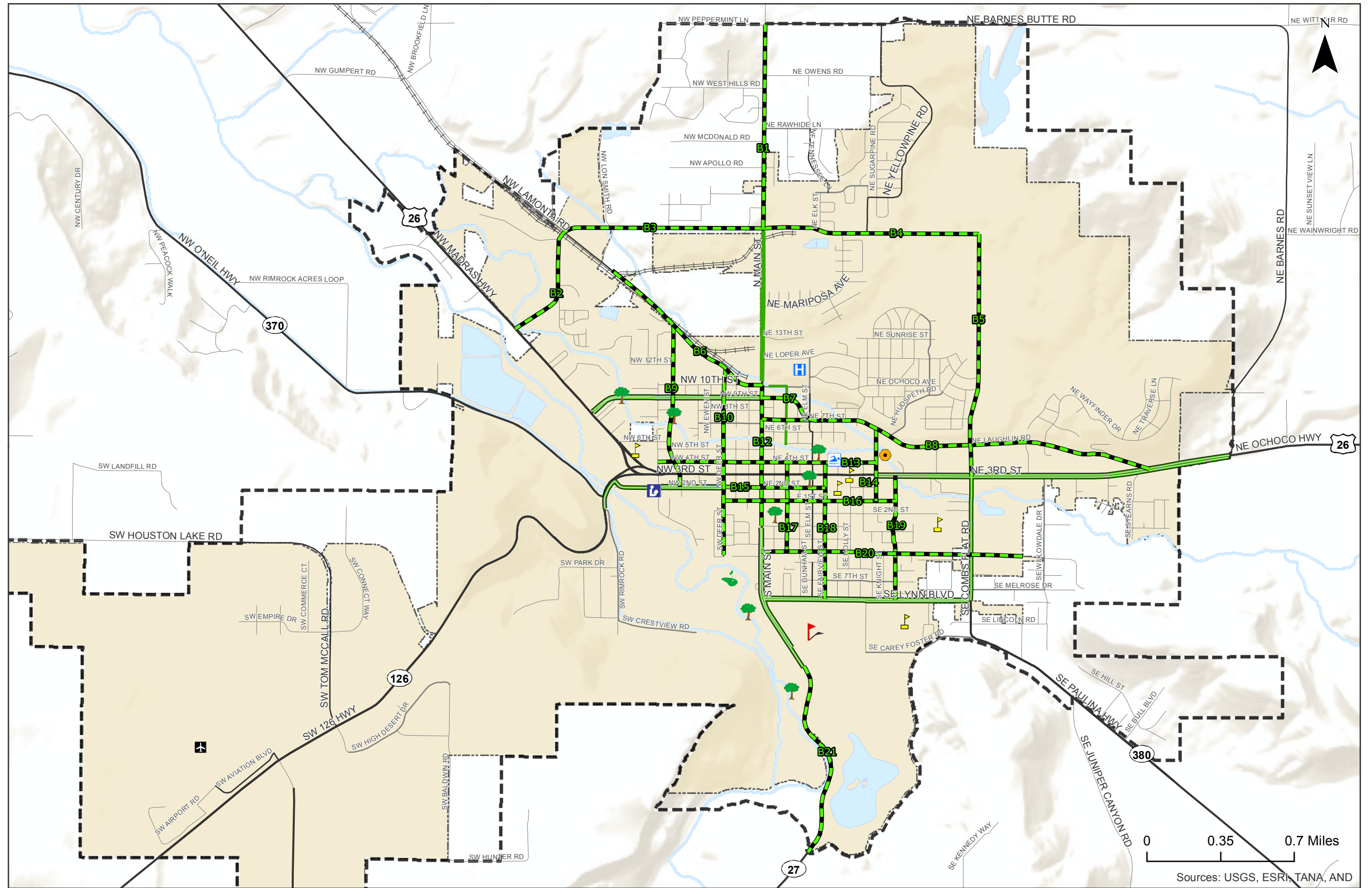

**Proposed Bicycle Facilities
City of Prineville, Oregon**

**Figure
7-4**

H:\projects\12221 - Prineville TSP\GIS\Map\7-4-Proposed Bicycle Facilities.mxd - jsomerville - 3:23 PM 6/7/2013

Multi-Use Paths

Multi-use trails provide pedestrians and bicyclists with a path separated from motor vehicles. The City currently has a multi-use path that runs along the Ochoco Creek between Harwood Avenue and Juniper Street. In addition, there is a multi-use path that runs along US 26, as shown in Figure 7-5. As discussed in the Crook County Parks and Recreation District Master Plan, the City hopes to provide a connected network of trails and greenways along the Ochoco Creek, McKay Creek, and the Crooked River. The Master Plan calls for an additional seven miles of pathways and seven miles of trails. In addition, the plan encourages the City to look for opportunities to provide trails in existing developments or new development.

Figure 7-5 shows existing multi-use trails within the City as well as key multi-use trail connections shown in the Master Plan. In order to achieve the City's goal of providing a continuous trail network, the following have been identified as priorities for the trail system:







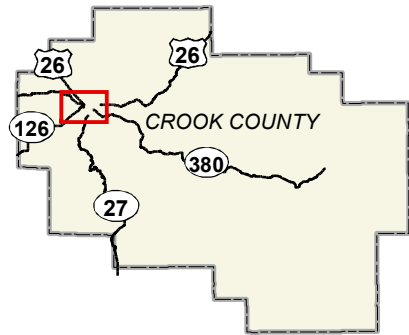







- Add a crossing or underpass of OR 126 near the intersection of O'Neil Highway where trail M1 begins, or consider siting a crossing to the east where speeds are lower.
- Add a crossing of 3rd Street near the intersection of Knowledge Street where the existing multi-use trail crosses 3rd Street to increase the safety of pedestrians and bicyclists using the trail. Features such as high visibility striping, pedestrian-activated beacons or signals, and signage should be considered to improve visibility and yielding compliance.
- Continue to trail east of Combs Flat Road and through the former Ochoco Lumber site. Similar to the 3rd Street crossing, consider high-visibility and compliance treatments on the highway.

TRANSIT

The current park-and-ride location for Cascades East Transit is a gravel area located within the Prineville "Y." The current facility does not provide an ideal connection, and relocation of the transit stop should be considered a priority. Central Oregon Intergovernmental Council is completing a regional park-and-ride study that will assess other potential sites within Prineville and provide recommendations of the number of parking stalls, features, and amenities that will enable transit to better serve the City of Prineville.



Destinations

-  Airport
-  Fairgrounds
-  Golf Course
-  Hospital
-  Library
-  Pool
-  School
-  Skatepark
-  Park
-  Proposed Paved Multi-Use Path
-  Proposed Unpaved Multi-Use Path
-  Existing Multi-Use Path
-  City Boundary
-  Study Area/Urban Growth Boundary (UGB)

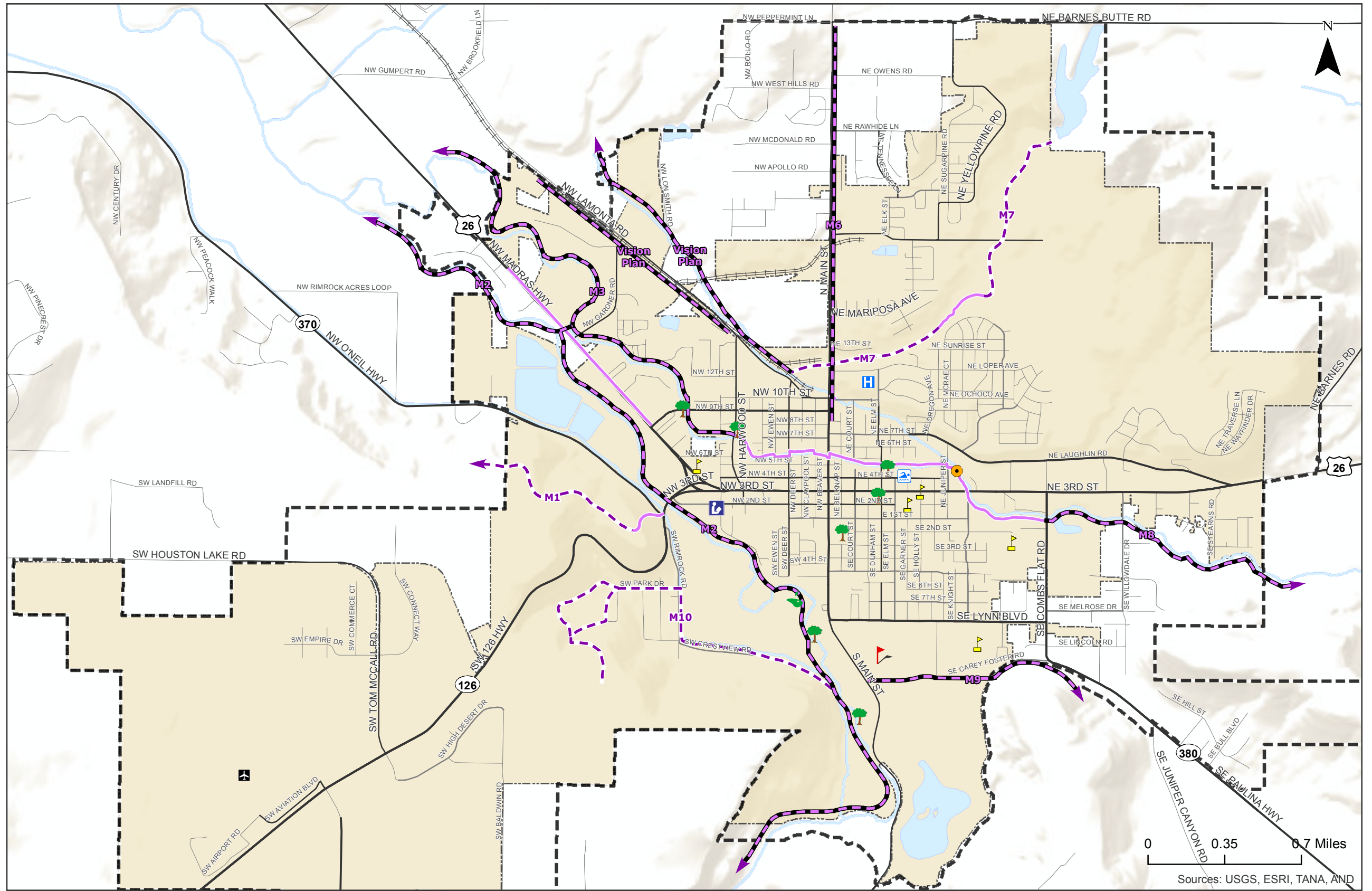

0 0.35 0.7 Miles

Sources: USGS, ESRI, TANA, AND

**Proposed Multi-Use Trails
City of Prineville, Oregon**

**Figure
7-5**

H:\projects\12221 - Prineville TSP\GIS\Map\7-5 Proposed Multi-Use Trails.mxd - 3:53 PM 6/7/2013

FREIGHT

Primary freight connections to the City of Prineville include the highway system (OR 126 and US 26 are designated freight routes) and the City of Prineville Railway (COPR). The COPR system provides an 18-mile shortline service between the City and the Class 1 BNSF mainline in Redmond, with daily switching operations at the Prineville Junction located just north of Redmond along the US 97 corridor.

Roadway Freight

US 26 and OR 126 are designated as freight routes west of the Prineville “Y”, but where the highways join the freight route designation is removed. Despite removal of this designation, truck volumes are a considerable component of the highway traffic in Prineville, comprising between 11 percent and 30 percent of the overall traffic volumes, with half of these trucks single-unit delivery vehicles.

Based on the volume of freight traffic, it is recommended that design features of the highways account for the dimensional and maneuvering needs of truck traffic regardless of whether the highways are designated freight or truck routes within the City. It is recommended that a City of Prineville Truck Route designation is provided along all of the highways to highlight the importance of freight movements along these routes.

In addition to the State system, the following local streets should also be designated as City freight routes based on the land uses served and connections provided:

- Main Street between Peters Road and the southern City boundary.
- Lamonta Road from the west UGB to Main Street.
- 9th Street from US 26 to Main Street, and a future extension of 9th Street (or 10th Street) east.
- Peters Road extension between US 26 and Main Street.

Rail Freight

With the closure of the Ochoco Mill, the City of Prineville recently abandoned a City-operated spur rail line between Main Street and Combs Flat Road, converting the right-of-way into a trail. The abandonment of this rail line removed eight at-grade rail crossings within the City, including a crossing of US 26, Combs Flat Road (OR 380), and Main Street.

Despite the abandonment of the spur line, the City has increased its investment in the COPR shortline service to the Prineville Junction. With assistance from Connect Oregon grants, the City has recently completed construction of a freight depot, which provides significant warehousing space, equipment ramps, freight to rail intermodal service, and bulk product storage. The site is located along Bus Evans Road between Lamonta Road and US 26, approximately two miles west of the City.

The location of this site further justifies the City freight route designation of Lamonta Road, and will also require coordination with Crook County for the portion of Lamonta Road located outside of City limits.



AIRPORT

Proposed connections between Tom McCall Road and Airport Road will provide off-highway connectivity to improve integration of the business park with the airport. Additionally, airport traffic will have improved access to OR 126 with traffic control improvements proposed at the Tom McCall Road intersection. The City and Crook County are preparing to update the airport master plan, which will identify additional improvement needs over the planning horizon.

Preserving access to the airport will remain a City priority, and improvement plans at the OR 126/Tom McCall intersection and its associated frontage road system will retain this access.

PROJECT COSTS AND FUNDING OPTIONS

The preferred plan includes improvements to the roadway, pedestrian, bicycle, and multi-use trail network. These projects, summarized in Table 7-2 through Table 7-7, were identified based on their ability to accommodate growth within the City during the upcoming 20 years. Planning-level cost estimates were generated for each project based on unit costs and length of projects. These project cost estimates are preliminary and will be further refined for the final TSP.

Review of the projects and listed priorities included in Tables 7-2 through 7-7 results in total project costs exceeding \$38 million, which does not include right-of-way, on-going maintenance,

or improvements to the City's local streets. The costs associated with these projects would be shared between the City of Prineville, Crook County, ODOT, private development, and potentially through volunteers and other interests. Primary funding sources are subject to change per discussion between agency representatives.

Based on the project's need and relative cost, projects were identified as near-term, medium-term, or long-term projects. Near-term projects are projects with the highest priority due to their ability to mitigate an identified need within the City and their lower relative cost. The timeline for implementation was based on suggestions from the consultant team and reviewed by the TAC and PAC. Timelines do not restrict or require completion of all short-term projects prior to the implementation of medium-term projects, but they are an indication of the priority to the City and its residents.

Estimated costs for near-term projects alone would exceed the expected SDC revenue over the 20-year period. Developing partnerships will be critical for the City's funding, particularly as the design of the overall preferred alternative is premised on relieving the highway through creation of lower-cost City routes.

Many of the City's near-term costs for projects are associated with sidewalk improvements throughout the City that were identified through Safe Routes to Schools or for connectivity purposes. Costs for multi-use pathways could be significantly reduced through volunteer efforts, initial trail creation with dirt surfaces, with successive enhancements provided over time.

The City should consider the following options as ways to help fund the transportation improvements identified in the TSP:

- The creation of parallel local routes to support the 3rd Street corridor can be accomplished through a strong partnership between ODOT, the County, the City, and the local landowners of the private lands that these new connections traverse. A variety of cost-sharing and funding mechanisms can be investigated as specific corridor strategies are identified. These mechanisms should include provisions for phasing of construction as well as potential reimbursement.
- The City's existing transportation System Development Charge (SDC) program should be updated following adoption of the TSP. The City Council needs to carefully consider the implications on the future rate assessed on both economic development potential and the percentage of future transportation revenue needs that can be reasonably relied upon for funding by SDC.
- Development of the airport industrial lands provides the City with franchise fees and other revenue sources allocated to the City's general fund. Continued development of these lands requires power, water, sewer, *and* transportation services; as such, an equitable methodology to allocate some of these funds to transportation infrastructure costs can be investigated by the City.
- Due to declining revenue, both traditional and non-traditional partnerships and funding sources should be actively pursued by the City. This can include volunteer efforts to initiate trail construction, pursuance of grants, public/private partnerships, and coordination with State and County interests to help fund transportation projects.

Table 7-2 Roadway Projects

Project Number	Name	Description	Cost	Timeline	Short Term/Maintenance Project?	Project Justification	Primary Funding Source	Right of Way
R6	Main St between 9th and Peters road-	restriping to 3 lanes	striping removal; restriping	\$55,000	Near-Term	yes	operations	City
R8	Combs Flat between US 26 and Lynn	widen to arterial standard - including off street path	\$2,634,240	Near-Term	no	operations	City	
R9	3rd St signal coordination		\$50,000	Near-Term	no	operations	ODOT	
R12	5th St extension - east of Combs Flat	Complete 5th Street with Ochoco development	\$1,764,000	Near-Term	no	private development/connectivity	private	
R1	9th Street Extension	Complete connection	\$2,520,000	Medium	no	operations	City/ODOT	
R3	Combs Flat Road Extension/Connection with Peters Road	Laughlin north to Peters	\$6,854,400	Medium	no	private development/connectivity	private	
R7	Combs Flat between US 26 and Laughlin	upgrade to arterial standards.	\$415,800	Medium	no	operations	City	
R11	2nd Street extension - between Fairview St and Holly St	add 650' of new road (Major Collector)	\$655,200	Medium	no	connectivity	City	
R13	5th St extension - west of Combs Flat		\$1,764,000	Medium	no	connectivity	City	
R2	Peters Road Connection to Lamonta	aligns with Gardner	\$3,996,720	Medium	no	operations	City/ODOT	
R10	Elm Street extension between SE 5th and 6th	add 270' of new road (Major Collector)	\$272,160	Long	no	connectivity	City	
R3-2	Combs Flat Road Extension- North from Peters Road to Barnes Butte	Peters north to Barnes Butte	\$6,854,400	Vision	no	private development/connectivity	private	
R5	Crestview Extension		n/a	Vision	no	safety (alt route to Rimrock Rd)	N/A	

Table 7-3 Intersection Projects

Project Number	Name	Description	Cost	Timeline	Short Term/Maintenance Project?	Project Justification	Primary Funding Source	Right of Way
	Tom McCall – Millican Intersection	Signal or Roundabout, frontage roads	\$5 million	Near-term	No	Safety, economic, capacity	City/County/ODOT/Private	
I33	Combs Flat & Future 5th St extension	add signal	\$325,000	Near/Long	no	private development/safety	private	n/a
I1	10th & Main	add signal	\$325,000	Near-Term	no	operations/safety	Funded	Unknown
I3	4th & Main	install 4 curb bulb-outs - assume 200 sq ft of concrete for each; install 2 ladder crosswalks on Main St	\$21,395	Near-Term	yes	safety	City	n/a
I9	Combs Flat & US 26	signal modification for widening	\$180,000	Near-Term	no	operations/safety	City/County/ODOT	
I10	Laughlin & US 26	restripe intersection	\$10,538	Near-Term	yes	safety	City/ODOT	
I12	Deer & 2nd	larger STOP sign, STOP striping, ladder crosswalks	\$2,500	Near-Term	yes	safety	City	
I28	Lamonta & Harwood	restripe Lamonta/Harwood (assuming no widening)	\$10,395	Near-Term	yes	safety	City	
I34	10th & Lamonta	realign intersection	\$65,000	Near-Term	Yes	safety	City/ODOT	
I15	Combs Flat & Lynn	add 2 left-turn lanes; add new signal	\$650,360	Medium	no	operations	City/County/ODOT	
I27	Combs Flat Rd & Laughlin Rd	Add 2 left-turn lanes; add signal	\$591,560	Medium	no	operations	City	

Table 7-4 Pedestrian Projects

Project Number (Fig 7-3)	Name	Description	Cost	Timeline	Short Term/ Maintenance Project?	Project Justification	Primary Funding Source	Right of Way
P7	NE Oregon St - Laughlin to Allen	sidewalks, curbs	\$62,500	Near-Term	no	schools	City	
P8	NE Laughlin Rd - Garner to Combs Flat	sidewalks, curbs	\$789,000	Near-Term	no	schools	City	
P13	Combs Flat Rd between 3rd St and Lynn - path included in roadway estimate	multiuse pathway	Included in R8	Near-Term	no	schools	City/ODOT/ Private	
P14	5th St - existing section only	sidewalks, some curbs	\$254,000	Near-Term	no	schools	City	
P15	Lynn Blvd	sidewalks, curbs	\$285,500	Near-Term	no	schools	City	
P17	O'Neil Hwy pedestrian crossing	crosswalk	\$20,000	Near-Term	no	connectivity	City/ODOT	
P18	3rd Street crossing at trail crossing - add median, 4 RRFBs, ladder crosswalk	crosswalk	\$108,175	Near-Term	no	safety	City/ODOT	
P20	crossing of Combs Flat Rd - assume RRFBs	crosswalk	\$21,814	Near-Term	no	safety	City/ODOT	
P4	NE Peters Road - existing section only	sidewalks, curbs	\$258,500	Medium	no	connectivity	City	
P5	NE Loper Ave - Elm to Main	sidewalks, curbs	\$115,000	Medium	no	connectivity	City	
P10	Deer St - 1st St to the creek	sidewalks	\$42,150	Medium	no	connectivity	City	
P11	Fairview - from Lynn to 4th st	sidewalks, some curbs	\$156,200	Medium	no	connectivity	City	
P1	Gardner Road	sidewalks, curbs	\$297,500	Long	no	connectivity	City	
P3	Main Street from 10th to UGB north boundary (NE Barnes Butte Rd)	sidewalks, curbs	\$883,500	Long	no	connectivity	City	
P9	NE Harwood Ave - 2nd to 10th	sidewalks	\$160,500	Long	no	connectivity	City	
P16	Main St between 1st St and South UGB boundary	sidewalks, curbs	\$683,850	Long	no	connectivity	City	
P12	2nd St extension	sidewalks	n/a	Redevelopment	no	connectivity	City	
P2	new Peters Road connection to Lamonta	sidewalks	n/a	When constructed	no	connectivity	City	
P6	Combs Flat Rd extensions	sidewalks	n/a	When constructed	no	connectivity	City	

Table 7-5 Bicycle Projects

Project Number (Fig 7-4)	Name	Description	Cost	Timeline	Short Term/Maintenance Project?	Project Justification	Primary Funding Source	Right of Way
B8	Laughlin Rd	bike lanes, widening	\$490,712	Near-Term	no	school	City	
B12	Main St - through downtown area (10th to 3rd)	bike lanes	\$2,800	Near-Term	no	connectivity/safety	City	
B13	NW 4th St	bike lanes	\$4,368	Near-Term	no	connectivity	City	
B14	Juniper St	bike lanes	\$1,440	Near-Term	yes	school	City	
B15	2nd St	bike lanes	\$2,000	Near-Term	yes	connectivity	City	
B19	Knowledge	bike lanes	\$2,480	Near-Term	no	school	City	
B20	SE 5th St	bike lanes	\$3,120	Near-Term	yes	school	City	
B4	Peters Road	bike lanes, some widening	\$80,080	Medium	no	connectivity	City	
B6	Lamonta	bike lanes, some widening	\$142,450	Medium	no	connectivity	City	
B10	Deer St	bike lanes	\$3,720	Medium	no	connectivity	City	
B16	1st St	bike lanes	\$3,460	Medium	yes	connectivity	City	
B18	Fairview	bike lanes	\$2,720	Medium	yes	connectivity	City	
B21	Main St - south between end of existing bike lanes and south UGB	bike lanes, widening	\$328,320	Medium	no	connectivity	City	
B1	Main St between Peters Rd and north UGB / NE Barnes Butte Rd	bike lanes, some widening	\$157,850	Medium	no	connectivity	City	
B2	Gardner Rd	bike lanes	\$2,412	Long	yes	connectivity	City	
B9	Harwood	bike lanes	\$3,264	Long	no	connectivity	City	
B17	Court St	bike lanes	\$1,780	Long	no	connectivity	City	
B3	new Peters Road connection (costs included in roadway project)	bike lanes	n/a		no	connectivity		
B5	new Combs Flat Rd connection (costs included in roadway project)	bike lanes	n/a		no	connectivity		
B7	new 9th St connection (costs included in roadway project)	bike lanes	n/a		no	connectivity		

Table 7-6 Multi-Use Trail Projects

Project Number (Fig 7-5)	Name	Description	Cost	Timeline	Short Term/Maintenance Project?	Project Justification	Primary Funding Source	Right of Way
M1	O'Neil Hwy Trail	shared use trail - unpaved	\$89,540	Near-Term	no	connectivity	City/County	
M3	Ochoco Creek Trail - North	shared use trail - paved	\$841,295	Near-Term	no	connectivity (through City, and with existing trail)	City/County	
M8	Ochoco Creek Trail - South	shared use trail - paved	\$441,545	Near-Term	no	connectivity (through City, and with existing trail)	City/private	
M10	Look-out trail	shared use trail - unpaved	\$204,960	Near-Term	no	connectivity	private	
M2	Crooked River Trail	shared use trail - unpaved	-	Medium	no	connectivity	volunteers	
M7	Iron Horse Trail	shared use trail - unpaved	\$166,540	Medium	no	connectivity	City/private	
M9	Carey Foster trail	shared use trail - paved	\$353,665	Medium	no	connectivity	City/County	
M4	Lamonta Trail	shared use trail - paved	\$383,890	Vision	no	connectivity	City	
M5	Canal Lateral Trail	shared use trail - paved	\$470,405	Vision	no	connectivity	City	

Table 7-7 Transit Projects

Project Number	Name	Description	Cost	Timeline	Short Term/ Maintenance Project?	Project Justification	Primary Funding Source	Right of Way
1	Park and Ride Relocation and Development	Create a park and ride lot	TBD	Near-Term	no	Regional Transit link	ODOT	

Section 8 TAC/PAC Meeting Minutes



CITY OF PRINEVILLE TRANSPORTATION SYSTEM PLAN



Joint PAC/TAC Meeting #1 Minutes

Meeting Date: June 13, 2012

Meeting Time: 2:30 p.m.

Black text below reflects the meeting agenda and all blue text reflects comments or input received.

Meeting Invitees:

TAC Members

PAC Members

Consultants

Meeting Agenda:

Introductions

List of stakeholders came about through OR 126 members and additional interests to represent the public and City as a whole.

Project Overview

- a) Project study area/background
- b) Project purpose and need
- c) Deliverables & meetings
- d) Project schedule
 - i. Integrate COIC Regional Master Plan Updates, which will be available after August meeting and another in fall 2013.
- e) Roles & responsibilities
- f) Public project website (<http://sites.kittelson.com/prinevilletsps>)

Discuss Draft Technical Memorandum #2: Goals & Objectives

Desired Project Outcomes/Definitions of Success for Project

Those in attendance provided the following comments:

- Jen: Wholesale/importing firm (overweight/international) no turn lanes at Tom McCall; consider dimensional needs on freight routes
- Brian Harmon: Geometric issues at intersections
- Scott Smith: SDC concern, how Tom McCall intersection burden gets distributed. From maintenance standpoint, re-identify alternative routes to the north. North Main primary entrance, alternative route around Barnes Butte circuitous. 2nd Street is an improvement, what can we look to build and maintain (snowplow, sanding, etc.)



CITY OF PRINEVILLE TRANSPORTATION SYSTEM PLAN



- Eric Klann: Plan falls short with lack of specific direction. Staff desires a specific blueprint rather than punting on issues. Want there to be implementation plans for each project. Phased solutions that can incrementally build toward the ultimate needs. Current SDC costs do not fully allow projects to be constructed.
- Toby: Preservation/enhancement of the rail lines. Movement between Depot and rail. Look to minimize grade crossings for safety and maintenance.
- Kevin Cole: Improving the grade, consider alternative ideas for getting into town
- Muriel Delavergne-Brown, Public Health Director: Completed health assessment along with COIC. Heard concerns about walking/biking safety. How do you improve the County Health rankings to foster economic development/livable communities?
- Steve Holiday (Prineville Disposal/Chamber): Flow/connectivity. 9th/Main for trucks. Tom McCall. Pedestrian/bicyclist traffic on Main Street, lack of facilities.
- Cathy Hudspeth (School district): school buses moved in a timely/safe manner
- Steve (City Council): Traffic flow at the “Y” from US 26 and OR 126, dispersing east-west traffic, maintaining respectful entrance into town. Consideration of other treatments in downtown Prineville. Parallel routes to Lynn Boulevard to minimize east-west and north-south routes. Plan for Ochoco lumber.
- Robert Morrow (ODOT): Consolidate/join accesses, consider designs. On-street parking considerations blocking sight distance. Juniper Canyon route – alternative from Hwy 27? Roundabout at the “Y”? Agreement on roundabouts from audience. Tom McCall does not function well at well.
- Devin (ODOT): Goal is to protect the function/capacity of OR 126, support local communities in reaching Goal 12 objectives.
- Josh Smith, City Planner: Connectivity, multi-modal. North Main terrible to bike down, high usage. Peters Road extension through Iron Horse, bicycle lane along Barnes Butte
- Bill Zelenka: Prior lack of community support was a barrier to solutions previously. OR 126 interface built consensus, will be important to carry momentum. Payment (City/County/ODOT) discussions will be critical; this project may not solve but can advance the discussion. County TSP does identify an alternative route to OR 126 (Brunner Road)
- Scott Edelman: Solid recommendations regarding funding/projects. Need to support businesses in town, reduce conflicts between local/ped issues. Concerns with pedestrians/bicyclists (motorized wheelchairs, other impairments). O’Neil junction pedestrian route into town. Police note that pedestrian safety along 3rd Street is key. At the “Y” pedestrians are especially vulnerable. Consider low-cost ped/bike treatments. Consideration of 9th Street truck route, want more business access.
- Dale Van Valkenburg (Brooks Resources): Economic change since 2005, likely a long haul. Recommend the roundabouts. Vision for Iron Horse may be different.
- Scott Aycok (COIC): integrates what transit can realistically offer. Can transit play a role in meeting cost differential. Livability. Park and ride, sidewalks. Implementation plan to pay for needs
- Deb Harper (Business owner): Warehouse in Baldwin, trucks along 9th at Main. Trucks down grade heading to Madras has geometric deficiencies. Pedestrians on Main Street are problematic.



CITY OF PRINEVILLE TRANSPORTATION SYSTEM PLAN



- Donna Barnes (Ochoco Lumber): traffic has increased from Juniper Canyon and schools. Combs Flat Road intersection is constrained. Not just transportation SDC, but total SDCs (sewer, water, etc.). Increase east-west and north-south options. Also improve connectivity to downtown to expand the downtown area. High student traffic through the Ochoco Lumber site.
- Ralph White (Planning Commission): hung up with large-cost projects such as interchanges in lieu of roundabouts. Looking for more creative solutions. Appreciated seeing the phasing plans. Main Street restriping to a three lane section.
- Phil Taylor (Central Oregon Truck): Efficient, safe access through traffic, navigating the "Y". Grade, shoulder access, pedestrian/bicycle access.
- Don Wood: Clear-eyed solutions. Look at altruistic solutions, future funding. Look at long-term solutions. Alternative entries into Prineville. City was originally connected to Shaniko. Offset intersections intolerable, need to fix the remainder. As things become more digital look to bring higher service internet.

Summary of Plan & Policy Review

Upcoming Work Activities

- Plans, Policy, Rules and Regulations – Technical Memorandum #1
- Existing Conditions Analysis – Technical Memorandum #3
- Future Conditions Analysis – Technical Memorandum #4

Key Near-Term Dates

- August 1 – Draft Technical Memorandums to TAC & PAC
- August 8 – PAC/TAC Meeting #2

Additional Comments/Questions and Summary of Identified Action Items

Kittelson action items:

- Post revised roadmap on website
- Add TPAU to TAC



CITY OF PRINEVILLE TRANSPORTATION SYSTEM PLAN



Joint PAC/TAC Meeting #2 Minutes

Meeting Date: November 29, 2012

Meeting Time: 2:30 p.m.

Black text below reflects the meeting agenda and all blue text reflects comments or input received.

Meeting Invitees:

TAC Members

PAC Members

Consultants

Meeting Discussion

Introductions, role, interest

Update on project

Revised Goals and Objectives

Existing Conditions Analysis

- Steve F. pointed out that OR 126 at Tom McCall and Airport Road reflects construction traffic. How long will that last? The temporary nature should be considered in the long-term forecasts.

Functional Classification Needs

- Scott Smith: north Main Street is an issue the City is aware of and has worked with Kittelson to address
- Devin: how much time do we want to spend on OR 126 intersections given that the Corridor Plan has just been completed? Enough to reflect revised ODOT travel demand models and to reflect ODOT's revised policy on roundabouts.
- Lynn Blvd at Main is not surprising, but mostly westbound right-turns.
- An east exit out of the north ridge residential development will help reduce congestion on Main Street.
- Options must be realistic, not assuming a new street through homes.
- Cost should be a primary consideration, not to constrain alternative development, but as the first criteria.



CITY OF PRINEVILLE TRANSPORTATION SYSTEM PLAN



- Scott Aycock: is there an opportunity to revise the land use in the comp. plan to reflect the revisions identified through the TSP (reflecting the analysis we do)? Example, REALMS school in Bend is outside of town, but they want transit.
- Eric: we need to consider cost at the front of the plan because the SDC must be a reasonable amount, if it is excessive the projects won't be built and/or development will not thrive.

Cross-Section

- Opportunities to update and improve consistency of standards and references.
- Planter Strips – must be wide enough to reduce trees hanging over roadway, planter strip could restrict access to the street/cars for some users, cities policy is to reduce planter strips, they also impact stormwater runoff, the city is dealing with this in private development. Many comments from TAC/PAC indicate that maintenance is major issue and they don't want them.
- 80% of city local streets are 56' wide with 80' right-of-way.

ODOT Travel Demand Model Overview

- No emergency travel along 3rd Street for response. Desperate need for traffic control plan, coordination of traffic signals. Consider speed transition farther upstream on the highway, farther up the grade. Consider speed reduction by Rimrock Road.

Traffic Safety

- City police know that congestion occurs on 3rd street, so they use other parallel routes that are faster.
- Most crashes occur on 3rd street, which are expected to be caused by aggressive driving or distracted driving (or combination).
- Pedestrian operations. Due east-west makes it difficult with the sun. Pedestrian behavior issue. 3rd/Meadowlakes, 20 mph speed.
- North Main is a key issue as well.
- Pedestrian crossing of O'Neil Highway due to barriers

Future No-Build Needs

- Initial operations results show that in 2035 the following intersections may operate with LOS D or E (Yellow on red, yellow, green scale): Main @ 7th, Main at 2nd, 3rd St @ Main, 3rd @ Combs Flat, and Lynn @ Fairview. The following intersection will operate with LOS F (red): Lynn @ Combs Flat, OR 126 @ Tom McCall, OR 126 @ Airport Way.



CITY OF PRINEVILLE TRANSPORTATION SYSTEM PLAN



- Rimrock Road connection to OR 126, second bridge option to 2nd Street
- Third Street (45mph) on east side just prior to 45 mph, should be reduced. Problem is east to 3rd/Main

Action Items

- KAI to review overall increases in VMT within the UGB for City's assessment of SDC.
- TAC/PAC to provide review of technical memorandums before Jan. 15 meeting

Upcoming Meetings/Deliverables

- TAC/PAC Meeting #3: January 15 @ 2:30 PM to discuss future alternatives to address 2035 traffic forecasts.
- KAI to prepare draft technical memorandums (Plan & Policy Review, Existing Inventory, and Existing Conditions Analysis) for TAC/PAC review and comment. These will be posted on the project website.



CITY OF PRINEVILLE TRANSPORTATION SYSTEM PLAN



Joint PAC/TAC Meeting #3 Minutes

Meeting Date: February 19, 2013

Meeting Time: 2:30 p.m.

Meeting Location: City of Prineville – City Hall Council Chambers (387 NE Third Street, Prineville, OR 97754)

Black text below reflects the meeting agenda and all **blue** text reflects comments or input received.

Meeting Invitees:

TAC Members

PAC Members

Meeting Discussion

Introductions

Update on Project Progress

Recap of Existing Conditions Key Issues

Future No-Build Needs

- Roadway
 - The city has a lot of angled parking to handle their parking demand. If you don't have those parking spaces – where do you handle the parking?
 - What about back-end angled parking? (Eugene has it.)
 - Research shows it reduces crashes.
 - People circle until they find a place to park. You'll get a lot of push back from people if you tried back-end spots.
- Pedestrian/Bike
- Cross Section
 - Comments on the cross-sections for functional classification types:
 - Eric: The City uses right-of-way to deal with storm water and utilities.
 - Scott: Even though the wide right-of-way is higher maintenance cost, the City can go in and do work without closing the roads, which is a pro for the wider streets.
 - Eric: The City is in process of updating standards and specifications. So if there are changes to the pedestrian, bike, or right-of-way standards, we need to let them know so that they can get it in.
 - Scott: The concern with the planter strip is who will maintain it. The City doesn't have the tools or expertise to maintain it. People tend to take ownership of it on their side of the sidewalk.



CITY OF PRINEVILLE TRANSPORTATION SYSTEM PLAN



- General comments from the room: People don't want planter strips. Planter strips don't get maintained.
- Scott: Planter strips limit handicap people from parking midblock and accessing the sidewalk.
- Dale (Iron Horse): Iron Horse is a proponent of planter strips, but he acknowledges that they have the ability to maintain it. He points out that with small yards, the planter strip area feels more like people's yard, so they maintain it. This doesn't happen as much with larger yards.
- When people plant trees in the planter strips, the tree grows over the street, and it becomes a problem for parking and street sweeping.
- Eric: The city would like to leave the planter strip as an option so that if you have a development that wants to install them and maintain them, they will be able to. In this case, the planter strips would look nice.
- Scott: The City wants people to be able to do what they want, but they will need to show that they can maintain the planter strips if they want to build them.
- Prineville likes wide streets. The wide streets are part of the City's history.
 - But these wide streets lead to higher speeds. The City needs to find a way to slow people down in the neighborhoods.
 - Scott: It's easier to receive funding for sidewalks if they have a buffer.
- Fire engines can't make some of the turns in Iron Horse, so the City needs to be sure that future cross-sections are wide enough for fire trucks to make turns.
 - The City now has standards and specs, so this won't happen again. The fire department also must sign off on plans.
 - Scott: School buses are also an issue.
- Safety
 - Comments about safety at the intersection of 2nd St and Deer St.
 - People are on their cell phones at this intersection.
 - It's part of a main route for high school students coming into town.
 - It's also becoming a main thoroughfare.
 - Main Street – People stop at the intersection rather than at the line for pedestrians.

Future Build Alternative Discussion

- Couplet Options
 - When you look at moving traffic onto 2nd Street, you change the neighborhood and characteristics of Prineville.
 - Steve: The fundamental question is do we want to focus on getting traffic through town or do we want to diffuse the traffic onto local streets, which is more expensive in the longer run. Do we want to differ that expense onto the community?



CITY OF PRINEVILLE TRANSPORTATION SYSTEM PLAN



- Steve: When you push traffic off of a state-maintained street, the City now has to fund the maintenance. He would like to put the heavy traffic on the main street through town.
- Devin (ODOT) points out that under the current funding scheme, we're all going into the same pot for funding now. Local and state agencies apply for money in the same way.
 - However, maintenance money is separate.
 - Enhancement projects are from the same fund.
 - ODOT and the City have different goals. The state's goal is to move people through the community.
- Eric: The City did a 2nd Street egress to pull people off of 3rd Street – could you use the model to give an idea of what percentage of 2nd Street trips are using it as an alternative to 3rd Street?
 - Scott: Now the City is getting wear and tear on 2nd Street, but funding comes from the gas tax, which is based on population. So the increased maintenance is an issue.
- Eric: The 2005 TSP talked about a couplet, which is part of the reason why the City did the 2nd Street egress. When the 2nd Street egress was done, was the game plan for the state to take over 2nd Street?
 - If 2nd Street becomes a couplet, then yes, the state would have to play a role because they are responsible for moving freight, etc.
- Steve: If the City does a couplet, it would expand the downtown core of the commercial area. His preference is for the couplet to be on 3rd and 4th Streets. He thinks that would be a community enhancement.
- Redmond has a couplet, and it doesn't work, from a business owner's perspective.
 - She doesn't think a 3rd Street couplet is a good idea.
 - If you want businesses to come to Prineville, you need something that starts higher up to get people into town.
- 4th Street has places that don't connect, and these places are highly valued by the community (school, park, etc.).
- Josh: The bridge on 3rd Street is already being built.
- Don and Marty: We need to look at 50–100 years out. Someone may have to extend the road farther. 2nd Street does not have the potential for that expansion.
- The City recently did a study on 2nd Street: it's a high volume street.
- The only reason 2nd Street works right now is that all the businesses are closed when people are traveling out of town so no one is parked.
- It's not just maintenance that's an issue, but also enforcement. The police department does not have the manpower to enforce traffic laws.
- Scott: Consider that you are going to have to replace parking if you remove it from some streets.
- The City does not have land that they own and can turn into parking lots.
- Steve: If you removed parking from 3rd Street, merchants would be devastated.



CITY OF PRINEVILLE TRANSPORTATION SYSTEM PLAN



- Removing parking was tried years ago.
- Marty: 4th Street provides room for potential growth (after the swimming pool is gone).
- How much traffic comes out of Juniper Canyon?
 - 25% of the County's population?
 - We can get an estimate of this number from TPAU.
- Parallel Routes
 - Attendees provided comments on maps.
 - An origin-destination survey would be helpful. Or at least use census data to show where people are coming from.
 - Don: Where did the connection off of Rimrock come from?
 - People wanted a 2nd access into Prineville if something happened.
 - Scott: There is an issue with the intersection of Rimrock and 126.
 - Marty: For residents of Crestview, there needs to be a secondary access for emergencies.
 - What improvements are included in the 2035 model?
 - Eric: In the Crestview area, vehicular connectivity is shown in the 2005 TSP. Please be sure you go through an analysis of this even though it's an expensive project. It needs to be shown on the map.
 - There may be other reasons to provide the access too: emergency access to development.
 - Don Wood: on the far south side, why don't you bring 126 across (it's not shown in the limits of the map). He thinks this would solve all the problems.
 - Are the City and County working together on this?
 - That connection is mentioned in the 2005 TSP.
 - KAI needs to integrate with county map.
 - Response: The challenge is that the connection is not a highway. It's an emergency access (possibly gravel) road.
 - Don: Prineville has always taken the short term approach, which has been a problem. The City needs to start thinking long term.
- Widening 3rd Street

Future Alternative Evaluation Criteria

Upcoming Meetings and Deliverables

- Alternatives Analysis and Funding Program – Tech Memo #6
- TAC/PAC Meeting #4: April 2 at 2:30 PM

Additional Comments/Questions and Summary of Identified Action Items

- KAI to summarize comments and identify alternatives.



CITY OF PRINEVILLE TRANSPORTATION SYSTEM PLAN



Joint PAC/TAC Meeting #4 Minutes

Meeting Date: May 7, 2013

Meeting Time: 2:30 p.m.

Black text below reflects the meeting agenda, and all blue text reflects comments or input received.

Meeting Invitees:

TAC Members

PAC Members

Meeting Discussion:

Introductions, Meeting Goals

Summary of Meeting #3 Outcomes

- Future Needs
- Alternatives Development
- Comments Received

Future Network Alternatives

- Functional Classification

We need to distinguish between future and vision projects better on functional class map

- Cross-section
 - Steve had concern with protecting City staff with the cross-sections. He is worried that if we're not finite about street width, a developer can come in and just create the minimum width – the City staff will have to justify itself.
 - City council wants the variation so that they aren't too tied down.
 - Joe pointed out that the new TSP will provide a deviation process for scenarios when they do deviate from standards.
 - Scott – so will we have variations on right-of-way width or just pavement with the proposed cross-sections?
 - ROW width dependent upon classification standard – so we'll always have ROW, the pavement width can vary.
 - Scott E. – How do you deal with (or do you even want) bulb-outs on freight routes?
 - Joe – you wouldn't want them on a freight route.
- Access Management

3rd Street Corridor Alternative Evaluation

- Parallel Routes
 - Do we have enough money to fund these?
 - The funding will come from many sources: ODOT, private developers, SDC, etc... more specifics on funding sources and constraints will be presented that the next meeting in June.



CITY OF PRINEVILLE TRANSPORTATION SYSTEM PLAN



- Who will determine what projects get built first?
 - We'll discuss cost next time.
 - And development will drive some of that.
 - Be sure to incorporate new school measure and plans for the hospital when determining funding.
- Concern voiced that both of the parallel routes are pulling trips off of US 26, and with most of trips coming from Bend/Redmond, the couplet should still be an option, because most traffic still must pass through the Y.
 - We are keeping the couplet as a vision project in the plan.
- Would the Peters Road connection be more like 9th Street connection in terms of width and cross-section? Because commenter believes there will be more truck traffic there.
 - Yes, it will be.
- One commenter believes that improving signal timing and coordination should be the first priority as a low-cost way to improve capacity first before constructing anything.
 - Joe confirmed that this is a need for the City, with no coordination among signals currently.
 - Scott: ODOT says it's hard for them to get a consistent timing because people in town are nice and stop to let people turn out.
 - Inconsistent speed limits are also an issue.
- On the parallel routes: are you factoring in traffic controls at the end of them? Because even if the routes are shorter, if the wait time at signals is too long, people will go around anyways rather than using the parallel routes.
 - Couplet Options
- Steve – if we want to eventually go to couplet, we need to start planning for that now and get it in the TSP now.
 - Joe: We do want to plan for it now and pick the right-of-way so that we can start planning and acquiring ROW, etc.
- If we did go to a couplet, 2nd St or 4th St would become an ODOT facility.
- On the 2nd St school property – there's a recently renovated (put \$200,000 into the building) school based health center – would you move that? It's used by all schools.
 - If you look at the front of Crooked River Elementary, it's the building to the right. The building will probably be bypassed by the 2nd Street extension if it occurs.
- Other cities have done a 2nd/4th street couplet (versus a 2nd/3rd St or 3rd/4th St couplet) – why did we not consider this? Because ODOT facilities have standards, and right now neither is to standard. You would have to build two new roads instead of one.
- One commenter felt that the couplet option is fine as long as you don't ignore the simple improvements first: Crestview, 9th St, Peters Road.
- Development participation isn't there for couplet like it is for other options (more partners for these new roads in redevelopment areas – not much redevelopment going on around 2nd or 3rd Street)
 - Widening 3rd Street

No comments – everyone seemed to agree that this wasn't a desirable option.

- Alternative Mobility

Other Corridor Improvement Alternatives



CITY OF PRINEVILLE TRANSPORTATION SYSTEM PLAN



- Most people avoid Elm St because it has a stop sign on every block. So we would need to fix this if we wanted to make Elm Street a better connection.
 - Elm St concept has been in TSP for a long time. With the hospital moving, not quite as critical – but the hospital site might become something else.
 - The property needed to complete the Elm Street connection was recently in foreclosure – is it still? The City might be able to get it for a good price.
- 5th Street connection – must go around football field.

Intersection Improvement Alternatives

- Tom McCall – a signal wouldn't be as surprising as it would have been previously because of the new lower speed limit in that area.
 - But, that's a temporary lower speed limit for construction.
- Prineville “Y” – right now you have yield signs instead of merge signs – why?
 - The angle from a truck driver who stops at a yield line doesn't allow him to see if he pulls all the way to the yield line and stops. This needs consideration of redesign to better sight distance for truck drivers.
- The “Y” area – a lot of discussion from people about pedestrian safety in this area – pedestrians are trying to get across the Y to the library, etc.
 - Pedestrian connectivity is a big issue here
 - You're also going to see a big increase in bicycle traffic due to the increase in proposed trails in the area – we haven't addressed bicyclists at this intersection
 - A median with a pedestrian refuge would be helpful, near Meadow Lakes. Attendees seemed to like the idea.
 - Shifting the very short connection from OR 126 to US 26 to the west would help improve the Y.
 - Steve H – (since he lives on Meadow Lakes) he thinks it would make sense to allow WB left turn and allow pedestrian crossings on west side of intersection.
 - He thinks limiting RIRO only would be a substantial financial impact.
 - He doesn't think NB left turn on Meadow Lakes would be an issue if restricted – people already use Harwood.
 - People currently use the space in the intersection as an EB left turn lane, can we make an EB left turn lane?
 - Kittelson needs to bring back more options for the Y junction.
- O'Neil Highway / Rimrock Area:
 - Marty – When you get down to bridge on OR 126, you don't realize there is a 2nd street turn-off because it looks like a bike lane. Needs more signage to encourage people to use it.
 - Should look more like an exit.
 - Scott – part of the problem is the bike path at the intersection –there is confusion with the striping.
 - Wintertime maintenance would be an issue with putting a small pull-out lane at O'Neil Highway/OR 126 intersection.
 - How many people currently try to go across from O'Neil to Rimrock as of right now? This seems like it would be a dangerous maneuver.
 - Walmart and Home Depot have moved, so people now use O'Neil Highway to get to north end of Redmond, meaning more people are using O'Neil Highway.



CITY OF PRINEVILLE TRANSPORTATION SYSTEM PLAN



- Peters Rd/Main – more trains are expected across rail spur that were previously using that line, so we will need to account for that.
- 9th/10th at Main Street
 - Attendees do not want both intersections signalized.
 - Steve – could we shift the 10th St intersection north of railroad since RR tracks have been taken out?
 - Scott: Yes, we're trying to get 10th St aligned to a normal intersection and get coordination between 9th and 10th.
 - With more traffic on Lamonta and no longer any railroad tracks – could we bring the future 9th St connection further up to connect with Lamonta?
 - Acquisition costs may offset construction costs.
- TIA's for some of the new developments show the need for signals at Main/Lynn, but these TIA's assumed full build-out. In the TSP, we are proposing signals at the intersection of Main/Lynn when warranted.
- Laughlin/US 26 – attendees don't want this be a square right turn. They like that it's easy to turn right on Laughlin when heading WB on US 26. This is helpful when pulling trailers.
 - This is where the buses turn around. They like having the small island to turn around.
 - If you have to stop on the highway before turning, attendees think there would be more rear-ends.
 - Josh: if you make it a T intersection, keep the right turn lane.
 - Scott – this issue has been discussed with ODOT. If the City does anything, they have to do it all, including take away access from residents, add turn lanes, etc.
 - Other comments: if you connect the proposed northern alignment with 7th street, you will have more traffic at this intersection.
 - This intersection is probably a signage problem that could be improved with better signage and striping.

Safety Improvement Alternatives

- 2nd/Deer intersection – Comment from a local resident: half the people don't stop at all at the intersection. The other half the time, the issue is that there are parked cars up the road, closer to 3rd St, that limit visibility. So sometimes you can't see the traffic approaching.
 - 85% of traffic was over the speed limit at the last count taken.
 - Intersection is fine, culture is causing the problem.
 - What about the flashing stop signs?
 - Scott - it's a law enforcement issue. They need people to issue tickets to change the culture and get people to stop.
 - Keep this culture in mind as you plan other routes around the city – by designing straight routes, people are likely to speed.
- Main/4th
 - Congestion from 3rd Street is backing up to the intersection – this could be improved by improving the 3rd Street signal
 - Josh – there is a visibility issue with the parked cars. You can't see to pull-out.
- 3rd/Combs Flat - left turns are the issue here.
 - But you have ROW issues that will be restrictive for widening the road.
 - Flashing yellow lights would be good on 3rd street.
- 3rd/Harwood – rear-end crashes are common here.
 - The number of driveways in this area is high.



CITY OF PRINEVILLE TRANSPORTATION SYSTEM PLAN



- One commenter thinks that a lot of this is due to frustration from being stuck in the Y – people speed up when they are able to.

Active Transportation Alternatives

- Laughlin – a crosswalk has been installed here now.
- Main Street (north side of City) – maps show multi-use trail and sidewalks, verify which one this is.

Funding Options: Will be discussed at the next meeting.

Additional Comments/Questions and Summary of Identified Action Items

Next meeting: June 4, 2013 at 2:30 p.m.



CITY OF PRINEVILLE TRANSPORTATION SYSTEM PLAN



Joint PAC/TAC Meeting #5, June 12, 2013

2:30 p.m. to 4:30 p.m.

City of Prineville – City Hall Council Chambers
387 NE Third Street, Prineville, OR 97754

Meeting Invitees:

TAC Members

PAC Members

Meeting Agenda:

2:30 Introductions, Meeting Goals

2:35 Preferred Plan Elements

- Functional Classification
- Roadway Connections

- Vision map – do we want to include the northern parallel route – Barnes Butte connection?
 - Identified to tie in with right of way purchase with a sewer line
- Dale: Combs Flat Road extension is shown too far east for where it is right now
 - Response: future alignments are approximate
- Melrose was in previous TSP – 5th Street was not. Is there a need for both of them to be at collector level?
 - Melrose connection could be local street
- Carey Foster – this is not a public right of way
 - Recreational trail is okay on the property, but roadway would be more difficult
- Fairgrounds Rd/Carey Foster connection
 - There is an issue of secondary access to get to the back of the hospital in case of emergency – so the connection to Main as a vision plan would be good for safety
- 9th/10th connection – which one should we show for that alternative?
 - We could leave it showing both (just not 7th) to keep options available
- UBA designation could be used on 3rd Street, on the east side of the City, to help reduce the speed limit:
 - Scott E – this aligns with what City has been doing (businesses can front street, etc)
 - General input from the group: this is a good idea
 - Important to fix crosswalks so that people go to crosswalks
 - Potentially remove pedestrian crossings to make people go to correct locations (too many crosswalks)
 - UBA can be a tool to lower speed limit, but if not, the roadside environment can also be used to drop speed (Devin)
- Northern arterial alternative – how will trucks use it?
 - Trucks will use Deer/Lamonta route to get to 10th



CITY OF PRINEVILLE TRANSPORTATION SYSTEM PLAN



- Intersection Treatments
 - Peters Road / Main intersection improvement
 - What's the priority of this?
 - It's development driven – when the property develops, it will happen.
 - Will 5th Street become a better through street than Lynn when the extension of 5th is complete? (and if so, is the Lynn/Combs Flat signal still necessary?)
 - 5th is still a residential street, even though you don't have to conflict with schools
 - But Lynn is still preferred route most likely, even though 5th Street will help relieve Lynn
 - OR 126/Laughlin intersection
 - Just restriping at this point
 - This ties in with UBA designation and reduction of speed coming in here
 - It would help the city maintenance with sanding if this became a traditional intersection (Scott)

- Safety Improvements
 - 2nd Street/Deer
 - View of stop sign for eastbound traffic may be blocked by a power pole.
 - Restricting parking may require that additional parking be added elsewhere.
 - Use of ladder crosswalks should be limited to specific locations (used primarily in school zones and downtown today) so that they don't lose effectiveness.
 - 4th/Main
 - Support for restricting parking near intersection to increase sight distance.

- Pedestrian and Bicyclist
 - O'Neil Hwy/OR 126 ped crossing
 - Could you go under 126? – seems to be preferred option, but would be expensive.
 - For the driver coming from town turning right on O'Neil – could this (the proposed crosswalk location) be a safety issue due to visibility of pedestrian?
 - These concerns will need to be considered in final design/study

 - Y junction (intersection with Meadow Lakes)
 - Maintain westbound left turn onto Meadow Lakes



CITY OF PRINEVILLE TRANSPORTATION SYSTEM PLAN



- Keep pedestrian crossing on west side – keep median
- Eliminate eastbound, northbound left turn
- Would it make more sense to make these improvements at Harwood since it's already a light?
 - This (Meadow Lakes) is a better pedestrian crossing location, so keep them at Meadow Lakes
- Pedestrian
 - Laughlin from Juniper to Hudspeth already has sidewalks (recently completed SRTS)
 - Main St (pedestrians should use hospital side, but many are not) – when the cross-section is changed from 4-lane to 3-lane, that should hopefully provide additional width. Consider reducing bike lane width and provide a 10-foot multi-use path. Maintenance and drainage needs to be worked out. Include as non-funded project for grant opportunities.
 - Should Fairview sidewalk project be shifted to Elm, if Elm is planned to be the north-south connection between Lynn and 3rd Street?
 - Elm Street connection is low priority, so for near-term sidewalk improvements, Fairview will still be the priority.
- Crossings
 - Add Combs Flat/Lynn crossing to the map
- Bike
 - Show bike lanes on the 2nd street extension to Combs Flat
- Multi-use trail
 - On Main south of Lynn (of Carey Foster) to UGB (and north of the downtown area instead of bike lanes)
 - Consider a connection to provide a loop.

3:45

Funding

- Funding:
 - Eric – question about private: Does that mean we're going to make someone pay and then not reimburse them?
 - Josh- we only reimburse up to 70%
 - We need partnerships to pay for everything we say we need
 - Scott- SDC's can't go to projects that are needed now – so they shouldn't be included in SDC total
 - SDC's also can't be used for maintenance
- Urban renewal district for downtown core would give additional resources
 - City council talked about it previously
- Dale
 - The school district project will be coming soon
 - Combs Flat isn't a part of that picture



CITY OF PRINEVILLE TRANSPORTATION SYSTEM PLAN



- There will be some SDC money coming in, but they won't build project
- Iron horse won't be growing any lots any time soon – there are still people building on empty lots (so not building the new Combs Flat extension any time soon)
- Problem with road – expensive to get up the hill because of pipe underneath
- Is 30% private really feasible in Prineville?
 - We have methods to bring industrial in, but do we have methods to entice commercial, others in?
- Eric – remember, this will be reset every 5 years or so, even though we're collecting for 20 years' worth of projects
- Dale – projects don't necessarily come in the order you plan them (because of development)
 - Dale: seems like it would be better to have people pay SDC's as high as would be needed to make the necessary improvements, and then the city can spend it in high priority areas with the City
- If Dale can estimate projects that they foresee coming within the next few years (development driven), that would inform our list of projects and timelines
- Local gas tax – has been talked about, but not likely in Prineville

4:15

Next Steps

- July- next meeting – separate meeting for the public
 - Next meeting is our final meeting – recommendation needs to be made.
 - So if we do a joint public meeting, we could incorporate public comments into the group's final recommendation
- Next meeting: Thursday, July 18th, at 6:30 pm, following an open house



CITY OF PRINEVILLE TRANSPORTATION SYSTEM PLAN



Public Workshop/Joint PAC/TAC Meeting #6 July 18, 2013

City of Prineville – City Hall Council Chambers
387 NE Third Street, Prineville, OR 97754

Meeting Invitees:

Public

TAC Members

PAC Members

Recent Changes to the Draft Plan

- Addition of the policy/implementation section based on input from Scott Edelman and Deborah McMahon
- Realignment of Combs Flat Road (remaining edits may be needed based on comments received)
- Addition of 2nd St extension to bike map
- Figures renumbered to match references in document

Public Workshop Comments

Comments from group and discussion regarding fixed route intracity and regional transit service, particularly in regard to providing transportation to seniors. Comment was brought up that improved regional transit service was desirable. Discussion noted the plans to relocate the park and ride lot to a more central location, but that additional multi-modal accessibility considerations, routes, and accommodations were needed to better provide access to the site beyond just a parking area.

Question was asked whether documents were available on our website, response was that they are (<http://sites.kittelson.com/prinevilleTSP>)

We asked the public about specific transportation concerns and issues in the City. The group brought up congestion on 3rd Street (particularly at 3PM in the afternoon). Main/4th Street safety issues were raised, as were speeds on the City's wider roadways.

Discussion with the group identified that the design for Main/10th improvements should include accommodations for chip trucks due to their unique design. The comments received regarding the Main Street changes (restripe as a three-lane

cross-section) were positive. It was noted that following trucks up the hill meant no passing, but that the tradeoff was more appropriate speeds within the City, particularly for drivers coming down the hill into town.

A comment was raised regarding shift changes with industry to avoid impacts to congested roadways. Scott Smith indicated that the shifts used to be coordinated when the mills were in full operation, but with the reduced hours this has not been necessary lately.

TAC/PAC Meeting Comments

Question was raised about whether sites that currently have two access points could be grandfathered in, so that if they remodel, they can keep both accesses rather than consolidating to one. Staff explained that this is a guideline, it's not rigid, so it will allow for some flexibility where needed.

Question was raised about whether you can force a neighboring property to provide access when the property adjacent to it develops. We explained that the redeveloping property will be granted a conditional access until a neighboring property also redevelops, at which point consolidation would occur.

Question was raised about whether you could do an infill minor arterial standard to help with constraints in locations where the right of way is already established. We will update the text of the report to explain that this is the unconstrained standard. City staff noted that they are guidelines, and they want the wide right of way to help with maintenance and storm water. However, they want the flexibility.

Dale has a refined cost estimate for the Combs Flat Extension from Laughlin to Hudspeth.

The intersection improvements I3 and I12 will be completed as part of maintenance improvements this summer.

Question was raised by City staff about whether we could calculate the number of trips each improvement project allows to come onto the system, because developments are paying for projects that have a lot of remaining capacity. For example, at full build out, how many trips can 9th Street handle until it's at capacity. Then they could divide the SDC over all the trips so that people pay their proportion.

We will think about whether there is a good way to calculate something similar to this.

The council does not want to tie the franchise fees to any on-going costs. They want to use them for one time fees to get projects completed around the City.

Questions about the timing and phasing of projects and funding source – how can you take the money into a pot and prioritize money where it is needed most rather than constructing site improvements?

Land use law prevents you from exacting from a developer if it's not related to the land. Is this something you can do with SDC money though?

City staff noted that they also need to figure out how to work out partnerships. Some projects reduce traffic from 3rd Street, but they cost more for the City in maintenance. How does ODOT come into this arrangement?

The TAC/PAC will review the draft and provide comments in one week. We will send out a revised draft in one week, including public comments. If no meeting is needed, the TAC/PAC will vote by an online poll. If a meeting is needed, it will be held Tuesday, July 30th at 3pm.